





OŚWIETLENIE ARCHITEKTONICZNE



Katalog produktów 2018

	ZASILANIE CZ: NAPÁJENÍ SK: NAPÁJANIE EN: VOLTAGE
	MOC CZ: PŮJIKON SK: PRÍKON EN: POWER
	TEMPERATURA KOLORU CZ: TEPLOTA CHROMATIČNOSTI SK TEPLOTA CHROMATIČNOSTI EN: COLOR TEMPERATURE
	WSPÓŁCZYNNIK ODDAWANIA BARW CZ INDEX REPRODUKCE BAREV SK INDEX REPRODUKČIE FARIEB EN: COLOR RENDERING INDEX
	ŚCIEMNIALNY CZ: STMÍVATELNÉ SK: STMIEVATEĽNÉ EN: DIMMABLE
	NIESCIEMNIALNY CZ: NESTMÍVATELNÉ SK: NIE JE STMIEVATEĽNÁ EN: NON DIMMABLE
	RODZAJ DIOD CZ: TYP LED SK: TYP LED EN: TYPE OF LEDS
	STRUMIEN ŚWIATLA CZ: SVĚTELNÍ TOK SK: SVĚTELNÍ TOK EN LUMINOUS FLUX
	KĄT ROZSYŁU ŚWIATŁA CZ: VYZAŘOVACÍ ÚHEL SK: VYZAŘOVACÍ ÚHOL EN ANGLES OF LIGHT DISTRIBUTION
PF	WSPÓŁCZYNNIK MOCY CZ: FAKTOR SIŁY SK: ÚČINNÍK EN POWER FACTOR
	I KLASA OCHRONNOŚCI CZ I TRÍDA OCHRANY SK: I RIEDA OCHRANY EN: I APPLIANCE CLASS
	II KLASA OCHRONNOŚCI CZ II TRÍDA OCHRANY SK: II RIEDA OCHRANY EN: II APPLIANCE CLASS
	III KLASA OCHRONNOŚCI CZ: III TRÍDA OCHRANY SK: III RIEDA OCHRANY EN: III APPLIANCE CLASS
	NAZWA PRODUKTU CZ: NÁZEV VÝROBKU SK: NÁZOV VÝROBKU EN: NAME OF PRODUCT
	CZUJNIK RUCHU CZ: POHYBOVÝ SENZOR SK: POHYBOVÝ SENZOR EN MOTION SENSOR
	FUNKCJA KORYTARZOWA CZ: CHODBA FUNKCE SK FUNKCIA KORIDORU EN: CORRIDOR FUNCTION
	CZUJNIK ZMIERZCHOWY CZ: SÚMARKOVÉ ČIDLO SK: SOUMARKOVÉ ČIDLO EN: DUSK SENSOR
	KOD KRESKOWY CZ: ČÁROVÝ KÓD SK: ČIÁROVÝ KÓD EN BARCODE
	ZDJĘCIE CZ: FOTOGRAFIE SK: FOTOGRAFIE EN: PHOTOGRAPHY
	WYMIARY CZ: ROZMERY SK: ROZMERY EN: DIMENSIONS
	MATERIAŁ OBUDOWY CZ: MATERIÁL POUZDRA SK: MATERIÁL KRYTU EN: STUFF OF CASE
	KOLOR OBUDOWY CZ BARVA POUZDRA SK: FARIEB KRYTU EN: COLOUR OF CASE
CE	CE CZ: CE SK: CE EN: CE
	RODZAJ TRZONKA ŻARÓWKI CZ: TYP ZÁVITU ŽÁROVEK SK: TYP ZÁVITU ŽIAROVIEK EN: SHAFT TYPE OF BULBS

	ROHS CZ: ROHS SK: ROHS EN: ROHS
	PRODUKT DO UŻYTKU WEWNĘTRZNEGO CZ: K VNITRNÍMU POUŽITÍ SK: K VNÚTRONÉMU POUŽITIU EN: FOR INTERNAL USE
	PRODUKT DO UŻYTKU WEWNĘTRZNEGO I ZEWNĘTRZNEGO CZ: K VNITRNÍMU NEBO VENKOVNÍMU POUŽITÍ SK: K VNÚTRONÉMU ALEBO VONKAJŠIEMU POUŽITIU EN: FOR EXTERNAL AND INTERNAL USE
IP	STOPIEŃ SZCZELNOŚĆ CZ: STUPIEŃ KRYTÍ SK: STUPIEŃ KRYTA EN: LEAKPROOFNESS
	OKRES TRWAŁOŚCI CZ: ŽIVOTNOST SK: ŽIVOTNOST EN: SUSTAINABILITY
	TEMPERATURA UŻYTKOWANIA CZ: PRACOVNÍ TEPLOTA SK: PRACOVNÁ TEPLOTA EN: WORKING TEMPERATURE
	NAPIĘCIE WEJŚCIOWE CZ: VSTUPNÍ NAPĚTÍ SK: VSTUPNÉ NAPĚTIE EN: INPUT VOLTAGE
	NAPIĘCIE WYJŚCIOWE CZ: VÝSTUPNÍ NAPĚTÍ SK: VÝSTUPNÉ NAPĚTIE EN: OUTPUT VOLTAGE
	PRĄD WYJŚCIOWY CZ: VÝSTUPNÍ PROUD SK: VÝSTUPNÝ PRŮD EN: CURRENT OUTPUT
	NAPIĘCIE TĘTNIEN CZ: NAPĚTÍ ZVLNĚNÍ SK: NAPĚTIE ZVLNENIA EN: VOLTAGE RIPPLE
	DŁUGOŚĆ KABLA CZ: DÉLKA KABELU SK: DĹŽKA KÁBLA EN: CABLE LENGTH
	ZAKRES REGULACJI CZ: ROZSAH NASTAVENÍ SK: ROZSAH NASTAVENIA EN: ADJUSTMENT RANGE
	TOLERANCJA NAPIĘCIA CZ: TOLERANCE NAPĚTÍ SK: TOLERANCIA NAPĚTIA EN: VOLTAGE TOLERANCE
	LICZBA PRZYCISKÓW PILOTA CZ: POČET TLAČÍTEK DÁLKOVÉHO OVLÁDÁNÍ SK: POČET TLAČIDIEL DIALKOVÉHO OVLÁDANIA EN: NUMBER OF REMOTE CONTROL BUTTONS
	DŁUGOŚĆ TAŚMY RGB CZ: DÉLKA RGB TAPES SK: DĹŽKA RGB TAPES EN: LENGTH OF RGB TAPES
	CZĘSTOTLIWOŚĆ CZ: FREKVENCE SK: FREKVENCIA EN: FREQUENCY
	ZASIĘG PILOTA CZ: ŘADY DÁLKOVÉHO OVLÁDÁNÍ SK: DIALKOVÉ RIADENIE RIADENIA EN: REMOTE CONTROL RANGE



STR

**OPRAWY ELEWACYJNE LED**

8-35

CZ: fasádní lampy LED / SK: fasádne LED svietidlá / EN: elevational LED lamps**OPRAWY ELEWACYJNE BEZ ŹRÓDŁA ŚWIATŁA**

36-74

CZ: Svítidla bez zdroje světla / SK: Svietidlá bez zdroja svetla / EN: Luminaires without a light source**OPRAWY DOGRUNTOWE**

75-77

CZ: Pozemní světlo / SK: Pozemné svetlo / EN: Ground Light**SŁUPKI LED**

78-83

CZ: LED Sloupky / SK: LED stĺpiky / EN: LED posts**SŁUPKI BEZ ŹRÓDŁA ŚWIATŁA**

84-90

CZ: Lampy z nerezové oceli / SK: Lámp z nehrdzavejúcej ocele / EN: Stainless steel lamps**OPRAWY SOLARNE**

91

CZ: Solární svítidla / SK: Slnéčné svietidlá / EN: Solar luminaires**OPRAWY Z CZUJNIKIEM PIR**

92

CZ: Svítidla se snímačem PIR / SK: Svietidlá so snímačom PIR / EN: Lamps with PIR sensor**OPRAWY WEWNĘTRZNE**

93-94

CZ: Vnitřní LED lampy / SK: Vnútorne LED lampy / EN: Indoor LED Lamps**SPOTLIGHTY**

95-98

CZ: Reflektory / SK: Spotlights / EN: Spotlight



OPRAWY NATYNKOWE BEZ ŹRÓDŁA ŚWIATŁA
CZ: Nadomítkové svítidla bez zdroje světla / SK: Nadomietkové svietidlá bez zdroja svetla / EN: Surface-mounted luminaires without light source

99-131



TRACKLIGHTY GU10
CZ: Lištové svítidlo GU10 / SK: Lištové svietidlo GU10 / EN: track light GU10

132-134



OPRAWY PODTYNKOWE BEZ ŹRÓDŁA ŚWIATŁA
CZ: Podomítkové svítidla bez zdroje světla / SK: Podomietkové svietidlá bez zdroja svetla / EN: Concealed luminaires without light source

135-142



OPRAWY SUFITOWE
CZ: stropní svítidlo / SK: stropné svietidlo / EN: ceiling luminaire

143-164



OPRAWY PRZYSCHODOWE
CZ: schodišřové svítidlo / SK: schodiskové svietidlo / EN staircase luminaire

166-167

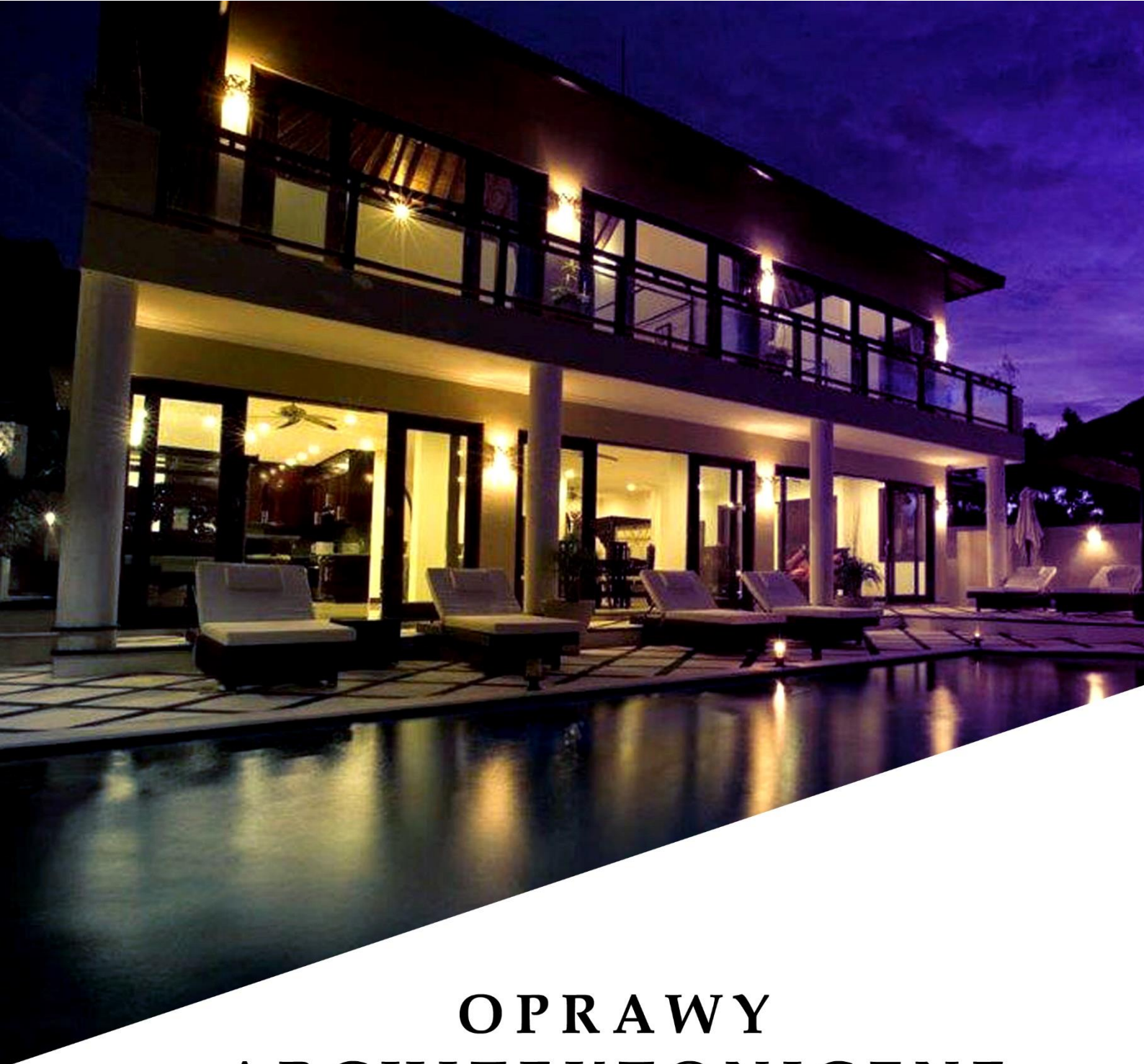

OPRAWY ARCHITEKTONICZNE

Szeroka i różnorodna gama opraw architektonicznych z przeznaczeniem do stosowania na elewacjach budynków, jako elementy dekoracyjne domów i mieszkań, w ogrodach, parkach, zieleńcach i miejscach wchodzących w skład tzw. małej architektury.

Oświetlenie architektoniczne tworzy szczególną atmosferę i unikalny wygląd przestrzeni wokół naszych posesji, a przy tym zwiększają wygodę i bezpieczeństwo jej użytkowników.

Dostępne są również oprawy z czujnikami ruchu oraz z panelami słonecznymi. Wszystkie oprawy posiadają obudowy wykonane ze stopów aluminium lub zestali nierdzewnej, co w połączeniu ze wysoką szczelnością wykonania opraw, oznacza, że są odporne na warunki atmosferyczne. Zastosowana nowoczesna technologia LED gwarantuje niskie zużycie energii elektrycznej, a co za tym idzie – niskie rachunki za prąd.

BIRK



OPRAWY ELEWACYJNE LED

CZ: fasádní lampy LED / SK: fasádne LED svietidlá / EN: elevational LED lamps



INDEX	ABC			Tc[K]		A [mm]	B [mm]	C [mm]	
004478	Birk LED	30 W	2100 lm	4500 K	Czarny Černá Čierná Black	145	170	225	5902216771062

AC 230V	COB	95°	NON-DIM
CRI(Ra)	40000 h	IP	IN&OUT
>75	CE	RoHS COMPLIANT	

Materiał / Materiał / Material

PL: aluminium

CZ: hliník

SK: hliník

EN: aluminium

Uwagi / Komentář / Komentáre

PL: Zasilacz w komplecie

CZ: Napájení je součástí dodávky

SK: Napájanie je súčasťou dodávky

EN: Power supply included

Brolux

www.bowi.com.pl

OPRAWY ELEWACYJNE LED

CZ: fasádní lampy LED / SK: fasádne LED svietidlá / EN: elevational LED lamps



INDEX						A [mm]	B [mm]	C [mm]	
004492	Bitel LED	18 W	1620 lm	4500 K	Czarny Černá Čierná Black	150	150	175	5902216771055

AC 230V	COB	40°	NON-DIM
CRI(Ra) >75	40000 h	IP 65	IN&OUT
RoHS COMPLIANT	CE	RoHS COMPLIANT	

Materiał / Materiał / Material

PL: aluminium

CZ: hliník

SK: hliník

EN: aluminium

Uwagi / Komentář / Komentáre

PL: Zasilacz w komplecie

CZ: Napájení je součástí dodávky

SK: Napájanie je súčasťou dodávky

EN: Power supply included

CARRI



OPRAWY ELEWACYJNE LED

CZ: fasádní lampy LED / SK: fasádne LED svietidlá / EN: elevational LED lamps



INDEX	ABC			Tc[K]		A [mm]	B [mm]	C [mm]	
009523	CARRI LED	3 W	130 lm	4000 K	Szary Šedá Šedá Grey	160	160	96	5902216720138
013704	CARRI LED	6W	660 lm	4000 K	Antracytowy RAL 7016 antracitová RAL 7016 antracitová RAL 7016 anthracite RAL 7016	160	160	97	5902808805342

AC 230V	Power LED	40°	NON-DIM
>75	40000 h	54	IN&OUT

Materiał / Materiál / Material

PL: aluminium

CZ: hliník

SK: hliník

EN: aluminium

Uwagi / Komentář / Komentáře

PL: Zasilacz w komplecie

CZ: Napájení je součástí dodávky

SK: Napájanie je súčasťou dodávky

EN: Power supply included

BroLux

www.bowi.com.pl

DOUBLE



OPRAWY ELEWACYJNE LED

CZ: fasádní lampy LED / SK: fasádne LED svietidlá / EN: elevational LED lamps



INDEX	ABC			Tc[K]		A [mm]	B [mm]	C [mm]	
004727	Double LED	2x3 W	400 lm	4000 K	Czarny Černá Čierná Black	100	92	90	5902216770904
1214	Double LED	3W	150 lm	4000 K		100	92	90	5902216770898

AC 230V	Power LED	80°	NON-DIM
>75	40000 h	54	IN&OUT

Materiał / Materiál / Material

PL: aluminium

CZ: hliník

SK: hliník

EN: aluminium

Uwagi / Komentář / Komentáre

PL: Zasilacz w komplecie

CZ: Napájení je součástí dodávky

SK: Napájanie je súčasťou dodávky

EN: Power supply included

Brolux

www.bowi.com.pl

OPRAWY ELEWACYJNE LED

CZ: fasádní lampy LED / SK: fasádne LED svietidlá / EN: elevational LED lamps



INDEX						A [mm]	B [mm]	C [mm]	
011483	Elkim LED	4 W	190 lm	4000 K	Szary Šedá Šedá Grey	205	205	74	5902216739154
001820	Elkim LED	4 W	190 lm	3000 K	Czarny Černá Černá Black	205	205	74	5902216719088
009320	Elkim LED	4 W	190 lm	4000 K	Černá Černá Černá Black	205	205	74	5902216712492

AC 230V	Power LED	90°	NON-DIM
>75	40000 h	54	IN&OUT

Materiał / Materiál / Material

PL: aluminium

CZ: hliník

SK: hliník

EN: aluminium

Uwagi / Komentář / Komentáre

PL: Zasilacz w komplecie

CZ: Napájení je součástí dodávky

SK: Napájanie je súčasťou dodávky

EN: Power supply included

GRACIN



OPRAWY ELEWACYJNE LED

CZ: fasádní lampy LED / SK: fasádne LED svietidlá / EN: elevational LED lamps



	INDEX			Lm	Tc[K]		A [mm]	B [mm]	C [mm]	
A	001579	Gracin LED	6 W	360 lm	3000 K	Czarny Černá Čierna Black	160	200		5902216719705
B	5553	Gracin LED	12 W	1000 lm	3500 K		160	300		5902216770836
C	002613	Gracin LED	12 W	1000 lm	3000 K		160	400		5902216719224

AC 230V	Power LED	30°	NON-DIM
>75	40000 h	54	IN&OUT

Materiał / Materiál / Material

PL: aluminium

CZ: hliník

SK: hliník

EN: aluminium

Uwagi / Komentář / Komentáre

PL: Zasilacz w komplecie

CZ: Napájení je součástí dodávky

SK: Napájanie je súčasťou dodávky

EN: Power supply included



ARCHITEKTONICZNE LAMPY LED

CZ: LED svítidlo/ SK: LED svietidlo/ EN: LED lamp



INDEX	ABC			Tc[K]		A [mm]	B [mm]	
011246	Sokul LED	12 W	452 lm	4000 K	Czarny Černá Čierny Black	220	50	5902216738140

AC 230V	SMD LED	180	NON-DIM
≥80	40000 h	55	IN&OUT

Materiał / Materiál / Material

PL: aluminium

CZ: hliník

SK: hliník

EN: aluminium

Uwagi / Komentář / Komentáre

PL: Zasilacz w komplecie

CZ: Napájení je součástí dodávky

SK: Napájanie je súčasťou dodávky

EN: Power supply included

FREON



OPRAWY ELEWACYJNE BEZ ŹRÓDŁA ŚWIATŁA

CZ: Svítidla bez zdroje světla / SK: Svetidlá bez zdroja svetla / EN: Luminaires without a light source

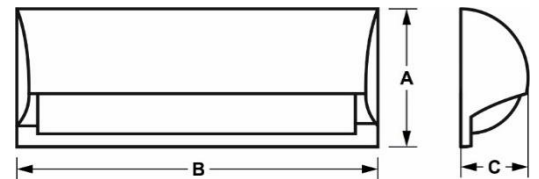
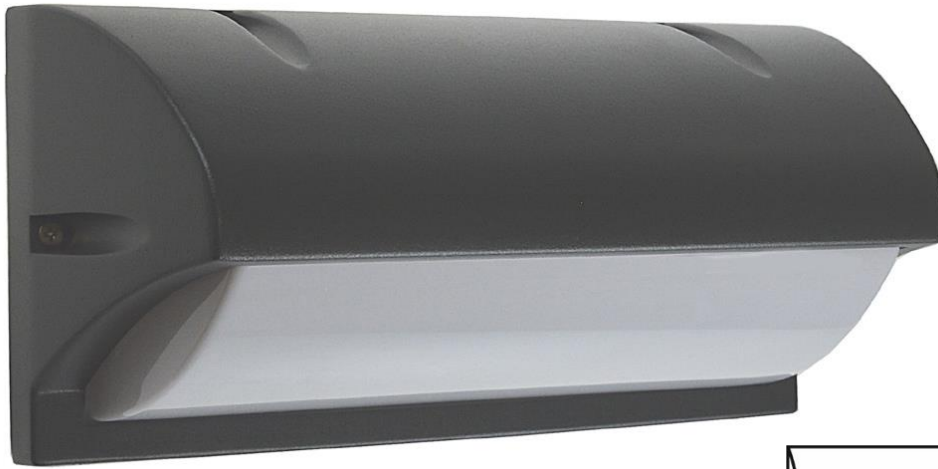

INDEX	ABC		A [mm]	B [mm]	C [mm]	
006946	Freon		125	250	114	5902808804109
012862	Freon		125	250	114	5902808804116
012869	Freon		125	250	114	5902216798243



AC 230V



E27

IP

54



IN&OUT



Materiał / Materiál / Materiál

PL: aluminium

CZ: hliník

SK: hliník

EN: aluminium

BroLux

www.bowi.com.pl

NALANI



OPRAWY ELEWACYJNE BEZ ŹRÓDŁA ŚWIATŁA

CZ: Svítidla bez zdroje světla / SK: Svetidlá bez zdroja svetla / EN: Luminaires without a light source



INDEX	ABC		A [mm]	B [mm]	C [mm]	
013603	Nalani	Antracytowy RAL 7016 antracitová RAL 7016 antracitová RAL 7016 anthracite RAL 7016	110	120	342	5902808804130
1185	Nalani	Czarny Černá Čierna Black	110	120	342	5902216719149



IP



AC 230V

E27

54

IN&OUT



Materiał / Materiál / Material

PL: aluminium

CZ: hliník

SK: hliník

EN: aluminium

Uwagi / Komentář / Komentáre

PL: Zasilacz w komplecie

CZ: Napájení je součástí dodávky

SK: Napájanie je súčasťou dodávky

EN: Power supply included



www.bowi.com.pl

NEELY







OPRAWY ELEWACYJNE BEZ ŹRÓDŁA ŚWIATŁA

CZ: Svítidla bez zdroje světla / SK: Svietidlá bez zdroja svetla / EN: Luminaires without a light source



A

B

		INDEX			A [mm]	B [mm]	C [mm]	
A		013604	Neely	Antracytowy RAL 7016 antracitová RAL 7016 antracitová RAL 7016 anthracite RAL 7016	260	125	125	5902808804147
B		9119	Neely	Czarny Černá Čierná Black	260	125	125	5902216719194



AC 230V



E27

IP

54



IN&OUT



Materiał / Materiál / Material

PL: aluminium

CZ: hliník

SK: hliník

EN: aluminium

Uwagi / Komentář / Komentáre

PL: Zasilacz w komplecie

CZ: Napájení je součástí dodávky

SK: Napájanie je súčasťou dodávky

EN: Power supply included



www.bowi.com.pl

ARAGO



OPRAWY ELEWACYJNE BEZ ŹRÓDŁA ŚWIATŁA

CZ: Svítidla bez zdroje světla / SK: Svietidlá bez zdroja svetla / EN: Luminaires without a light source



INDEX	ABC		A [mm]	B [mm]	C [mm]	
008945	Arago	Antracytowy RAL 7016 antracitová RAL 7016 antracitová RAL 7016 anthracite RAL 7016	145	70	240	5902216730793



AC 230V



E27

IP

54



IN&OUT



Materiał / Materiál / Materiál

PL: aluminium

CZ: hliník

SK: hliník

EN: aluminium

Uwagi / Komentář / Komentáre

PL: Zasilacz w komplecie

CZ: Napájení je součástí dodávky

SK: Napájanie je súčasťou dodávky

EN: Power supply included

BroLux

www.bowi.com.pl

ARIANA



OPRAWY ELEWACYJNE BEZ ŹRÓDŁA ŚWIATŁA

CZ: Svítidla bez zdroje světla / SK: Svietidlá bez zdroja svetla / EN: Luminaires without a light source



INDEX	ABC		A [mm]	B [mm]	C [mm]	
007044	Ariana	Antracytowy RAL 7016 antracitová RAL 7016 antracitová RAL 7016 anthracite RAL 7016	160	190	160	5902808805380



AC 230V



E27

IP

54



IN&OUT



Materiał / Materiál / Material

PL: aluminium

CZ: hliník

SK: hliník

EN: aluminium

Uwagi / Komentář / Komentáre

PL: Zasilacz w komplecie

CZ: Napájení je součástí dodávky

SK: Napájanie je súčasťou dodávky

EN: Power supply included

BroLux

www.bowi.com.pl

OPRAWY ELEWACYJNE BEZ ŹRÓDŁA ŚWIATŁA

CZ: Svítidla bez zdroje světla / SK: Svietidlá bez zdroja svetla / EN: Luminaires without a light source



INDEX	ABC		A [mm]	B [mm]	C [mm]	
002426	Brett	Antracytowy RAL 7016 antracitová RAL 7016 antracitová RAL 7016 anthracite RAL 7016	160	105	125	5902216722262



AC 230V



E27

IP

54



IN&OUT



Materiał / Materiál / Material

PL: aluminium

CZ: hliník

SK: hliník

EN: aluminium

Uwagi / Komentář / Komentáre

PL: Zasilacz w komplecie

CZ: Napájení je součástí dodávky

SK: Napájanie je súčasťou dodávky

EN: Power supply included

FALIN



OPRAWY ELEWACYJNE BEZ ŹRÓDŁA ŚWIATŁA

CZ: Svítidla bez zdroje světla / SK: Svietidlá bez zdroja svetla / EN: Luminaires without a light source



INDEX	ABC		A [mm]	B [mm]	C [mm]	
013708	Falin	Antracytowy RAL 7016 antracitová RAL 7016 antracitová RAL 7016 anthracite RAL 7016	220	104	130	5902808805403
1310	Falin	Czarny Černá Čierna Black	220	104	130	5902216771093



IP



AC 230V

E27

54

IN&OUT



Materiał / Materiál / Material

PL: aluminium

CZ: hliník

SK: hliník

EN: aluminium

Uwagi / Komentář / Komentáre

PL: Zasilacz w komplecie

CZ: Napájení je součástí dodávky

SK: Napájanie je súčasťou dodávky

EN: Power supply included



www.bowi.com.pl

OPRAWY ELEWACYJNE BEZ ŹRÓDŁA ŚWIATŁA

CZ: Svítidla bez zdroje světla / SK: Svietidlá bez zdroja svetla / EN: Luminaires without a light source



INDEX	ABC		A [mm]	 B [mm]	C [mm]	
002217	ZOE	Antracytowy RAL 7016 antracitová RAL 7016 antracitová RAL 7016 anthracite RAL 7016	125	125	260	5902808805397



AC 230V



E27

IP



IN&OUT



Materiał / Materiál / Materiál

PL: aluminium

CZ: hliník

SK: hliník

EN: aluminium

Uwagi / Komentář / Komentáre

PL: Zasilacz w komplecie

CZ: Napájení je součástí dodávky

SK: Napájanie je súčasťou dodávky

EN: Power supply included

OPRAWY ELEWACYJNE

OPRAWY ELEWACYJNE BEZ ŹRÓDŁA ŚWIATŁA

CZ: fasádní lampy LED / SK: fasádne LED svietidlá / EN: elevational LED lamps



A	009539	Barr LED	9 W	300 lm	3000 K	Szary Šedá Šedá Grey	120°	0.8	SMD LED	5902216738188
B	009556	Berad LED	8 W	450 lm	3000 K		120°	0.8	SMD LED	5902216738195
C	009536	Ciolla LED	3 W	130 lm	4500 K		30°	0.5	Power LED	5902216738201
D	009533	Cissa LED	2 W	150 lm	4500 K		60°	0.5	Power LED	5902216738218
E	009309	Dacu LED	3 W	170lm	4500 K		30°	0.5	Power LED	5902216739116
F	009558	Fray LED	8 W	450 lm	3000 K		120°	0.8	SMD LED	5902216739161
G	009579	Froda LED	12 W	650 lm	3000 K		120°	0.8	SMD LED	5902216739178
H	009584	Jonas LED	18 W	900 lm	3000 K		120°	0.9	SMD LED	5902216739185
I	009582	Jordi LED	3 W	130 lm	3000 K		120°	0.5	SMD LED	5902216739192
J	011481	Jordi LED	12 W	650 lm	3000 K		120°	0.8	SMD LED	5902216739208
K	009520	Ninion LED	2 W	80 lm	4500 K		30°	0.5	Power LED	5902216739215
L	009308	Parish LED	4 W	240 lm	4500 K		30°	0.5	Power LED	5902216739222
M	009404	Parr LED	4 W	120 lm	4500 K		120°	0.5	Power LED	5902216739239
N	011473	Uffa LED	12 w	750 lm	4500 K		40°	0.5	SMD LED	5902216739253



AC 230V NON-DIM IN&OUT



>75 40000 h 54



Materiał / Materiál / Materiál

PL: aluminium

CZ: hliník

SK: hliník

EN: aluminium

Uwagi / Komentář / Komentáre

PL: Zasilacz w komplecie

CZ: Napájení je součástí dodávky

SK: Napájanie je súčasťou dodávky

EN: Power supply included

Brolux

www.bowi.com.pl

OPRAWY ELEWACYJNE

OPRAWY ELEWACYJNE LED

CZ: fasádní lampy LED / SK: fasádne LED svietidlá / EN: elevational LED lamps



A



B



C



D



E



F



G



H



I



J



K



L



M



N

BroLux

www.bowi.com.pl

OPRAWY ELEWACYJNE

OPRAWY ELEWACYJNE LED

CZ: fasádní lampy LED / SK: fasádne LED svietidlá / EN: elevational LED lamps



INDEX



IP



A	005774	Brick LED	14×0,5 W	240 lm	4000 K	Czarny Černá Čierná Black	120°	IP54	Power LED	5902216770997
B	007478	Cissa LED	2 W	202 lm	3500 K		115°	IP54	Power LED	5902216719071
C	006347	Duck LED	4×1 W	200 lm	3500 K		100°	IP54	Power LED	5902216770881
D	1039	Falin LED	18 W	800 lm	3500 K		120°	IP54	Power LED	5902216770867
E	001890	Fuku LED	2×1 W	203 lm	3500 K		115°	IP54	Power LED	5902216719095
F	006346	Grif LED	2×1 W	200 lm	3500 K		115°	IP54	Power LED	5902216719163
G	251	Hagenal LED	10 W	800 lm	3500 K		120°	IP54	SMD LED	5902216718982
H	001050	Harli LED	2×7 W	320 lm	4500 K		270°	IP54	Power LED	5902216789708
I	001889	Helik LED	2×3 W	205 lm	3500 K		115°	IP54	Power LED	5902216719118
I	002636	Helik LED	1×3 W	180 lm	3500 K		80°	IP54	Power LED	5902216789715
J	008041	Jake LED	2×1 W	100 lm	3500 K		50°	IP54	Power LED	5902216770805
K	002584	Javan LED	25×0,2 W	200 lm	3500 K		120°	IP44	Power LED	5902216770799
L	001047	Javen LED	18×0,5 W	600 lm	3500 K		120°	IP44	Power LED	5902216770782
M	001341	Julet LED	2×1 W	100 lm	3500 K		50°	IP54	Power LED	5902216770775
N	5476	Karrell LED	3 W	200 lm	3500 K		120°	IP54	Power LED	5902216770768
O	1335	Mathe LED	6 W	480 lm	3500 K		120°	IP54	Power LED	5902216718999
P	008040	Nira LED	12×0,5 W	660 lm	3500 K		120°	IP54	Power LED	5902216719170
R	003150	Onix LED	7 W	206 lm	3500 K		120°	IP54	Power LED	5902216719125
S	002012	Ortal LED	5 W	290 lm	3500 K		120°	IP54	SMD LED	5902216721449
T	007395	Oryan LED	10 W	400 lm	3500 K		115°	IP54	Power LED	5902216789722
U	004512	Osmar LED	7 W	300 lm	3500 K	115°	IP54	Power LED	5902216788947	



AC 230V



NON-DIM



IN&OUT



>75



40000 h



Materiał / Materiál / Material

PL: aluminium

CZ: hliník

SK: hliník

EN: aluminum

Uwagi / Komentář / Komentáre

PL: Zasilacz w komplecie

CZ: Napájení je součástí dodávky

SK: Napájanie je súčasťou dodávky

EN: Power supply included



OPRAWY ELEWACYJNE

OPRAWY ELEWACYJNE LED

CZ: fasádní lampy LED / SK: fasádne LED svietidlá / EN: elevational LED lamps



A



B



C



D



E



F



G



H



I



J

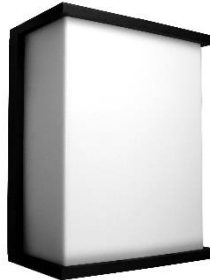

K



L



M



N



O



P



R



S



T



U

BroLux

www.bowi.com.pl

OPRAWY ELEWACYJNE

OPRAWY ELEWACYJNE LED

CZ: fasádní lampy LED / SK: fasádne LED svietidlá / EN: elevational LED lamps



INDEX



Tc[K]



IP



A	007467	Pocel LED	4 W	480 lm	3500 K	Czarny Černá Čierná Black	120°	IP54	SMD LED	5902216719002
B	5858	Pryde LED	20 W	900 lm	3500 K		120°	IP54	SMD LED	5902216721463
C	1236	Qiana LED	36×0,1 W	100 lm	3500 K		150°	IP54	Power LED	5902216770638
D	004770	Rees LED	10 W	800 lm	3500 K		120°	IP54	SMD LED	5902216719019
E	003237	Ronell LED	5 W	400 lm	3500 K		120°	IP54	SMD LED	5902216719026
F	002658	Rotri LED	2×5 W	800 lm	3500 K		120°	IP54	Power LED	5902216718951
G	6327	Saxan LED	3 W	160 lm	3500 K		120°	IP54	Power LED	5902216770553
H	5741	Scytta LED	6 W	320 lm	3500 K		120°	IP54	Power LED	5902216717053
I	3628	Sebald LED	3 W	160 lm	3500 K		120°	IP54	Power LED	5902216770546
J	3616	Sebald LED	2×3 W	320 lm	3500 K		120°	IP54	Power LED	5902216717060
K	3600	Sebbe LED	2×3 W	380 lm	3500 K		120°	IP54	Power LED	5902216717077
L	3534	Sebert LED	3 W	190 lm	3500 K		120°	IP54	Power LED	5902216770539
M	6060	Secga LED	6 W	480 lm	3500 K		120°	IP54	Power LED	5902216770522
N	000241	Selby LED	6 W	600 lm	3500 K		120°	IP54	SMD LED	5902216719644
O	001049	Tacara LED	4×1 W	380 lm	4500 K		30°	IP54	Power LED	5902216770508
P	001272	Tally LED	5 W	500 lm	3500 K		50°	IP54	Power LED	5902216770492
R	5261	Yuba LED	1×7 W	340 lm	4500 K		120°	IP54	Power LED	5902216770423



AC 230V



NON-DIM



IN&OUT



>75



40000 h



Materiał / Materiał / Material

PL: aluminium

CZ: hliník

SK: hliník

EN: aluminum

Uwagi / Komentář / Komentáre

PL: Zasilacz w komplecie

CZ: Napájení je součástí dodávky

SK: Napájanie je súčasťou dodávky

EN: Power supply included



www.bowi.com.pl

OPRAWY ELEWACYJNE LED

CZ: fasádní lampy LED / SK: fasádne LED svietidlá / EN: elevational LED lamps



A



B



C



D



E



F



G



H



I



J



K



L



M



N



O



P



R

FLOW



ARCHITEKTONICZNE LAMPY LED

CZ: LED svítidlo/ SK: LED svietidlo/ EN: LED lamp



	INDEX	ABC		Lm	Tc[K]			A [mm]	B [mm]	C [mm]	
A	013062	Flow LED	1x3 W	270 lm	4000 K	Zieleń mchu RAL 6005 Mechově zelená RAL 6005 Machovo zelená RAL 6005 Moss green RAL 6005		114	28	76	5902216799738
B	013063	Flow LED	1x3 W	270 lm	4000 K	Czarny Černá Čierny Black		114	28	76	5902216799745
C	013636	Flow LED	1x3 W	270 lm	4000 K	Antracytowy RAL 7016 antracitová RAL 7016 antracitová RAL 7016 anthracite RAL 7016		114	28	76	5902808804512
D	013064	Flow LED	1x6 W	540 lm	4000 K	Zieleń mchu RAL 6005 Mechově zelená RAL 6005 Machovo zelená RAL 6005 Moss green RAL 6005		172	29	76	5902216799752
E	013065	Flow LED	1x6 W	540 lm	4000 K	Czarny Černá Čierny Black		172	29	76	5902216799769
F	013637	Flow LED	1x6 W	540 lm	4000 K	Antracytowy RAL 7016 antracitová RAL 7016 antracitová RAL 7016 anthracite RAL 7016		172	29	76	5902808804529
G	013066	Flow LED	1x9 W	810 lm	4000 K	Zieleń mchu RAL 6005 Mechově zelená RAL 6005 Machovo zelená RAL 6005 Moss green RAL 6005		250	30	83	5902216799776
H	013639	Flow LED	1x9 W	810 lm	4000 K	Czarny Černá Čierny Black		250	30	83	5902808804536
I	013638	Flow LED	1x9 W	810 lm	4000 K	Antracytowy RAL 7016 antracitová RAL 7016 antracitová RAL 7016 anthracite RAL 7016		250	30	83	5902808804543

AC 230V	SMD LED	60	NON-DIM	>80	40000 h
IP	IN&OUT				

Materiał / Material / Material

PL: aluminium

CZ: hliník

SK: hliník

EN: aluminium

Uwagi / Komentář / Komentáre

PL: Zasilacz w komplecie

CZ: Napájení je součástí dodávky

SK: Napájanie je súčasťou dodávky

EN: Power supply included

FLOW



ARCHITEKTONICZNE LAMPY LED

CZ: LED svítidlo/ SK: LED svietidlo/ EN: LED lamp



INDEX



A [mm]

B [mm]

C [mm]



	INDEX	ABC	Power	Lm	Tc[K]	Color	A [mm]	B [mm]	C [mm]	Barcode
A	012878	Flow LED	2x3 W	540 lm	4000K	Zieleń mchu RAL 6005 Mechově zelená RAL 6005 Machovo zelená RAL 6005 Moss green RAL 6005	114	28	90	5902216789746
B	013069	Flow LED	2x3 W	540 lm	4000 K	Czarny Černá Čierny Black	114	28	90	5902216799783
C	013640	Flow LED	2x3 W	540 lm	4000 K	Antracytowy RAL 7016 antracitová RAL 7016 antracitová RAL 7016 anthracite RAL 7016	114	28	90	5902808804550
D	012879	Flow LED	2x6 W	1080 lm	4000 K	Zieleń mchu RAL 6005 Mechově zelená RAL 6005 Machovo zelená RAL 6005 Moss green RAL 6005	172	28	90	5902216719132
E	013068	Flow LED	2x6 W	1080 lm	4000 K	Czarny Černá Čierny Black	172	28	90	5902216799806
F	013067	Flow LED	2x9 W	1620 lm	4000 K	Zieleń mchu RAL 6005 Mechově zelená RAL 6005 Machovo zelená RAL 6005 Moss green RAL 6005	250	28	90	5902216799790



AC 230V



SMD LED



60



NON-DIM



>80



40000 h



54



IN&OUT



Materiał / Materiál / Material

PL: aluminium

CZ: hliník

SK: hliník

EN: aluminium

Uwagi / Komentář / Komentáre

PL: Zasilacz w komplecie

CZ: Napájení je součástí dodávky

SK: Napájanie je súčasťou dodávky

EN: Power supply included

BroLux

www.bowi.com.pl

ARCHITEKTONICZNE LAMPY LED

CZ: LED svítidlo/ SK: LED svietidlo/ EN: LED lamp

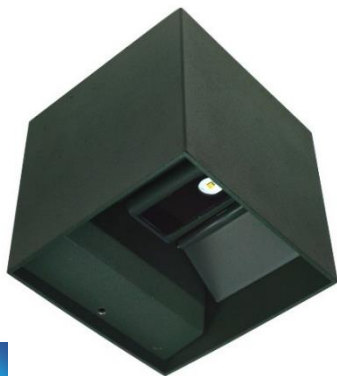

A

B

C

D



E

F

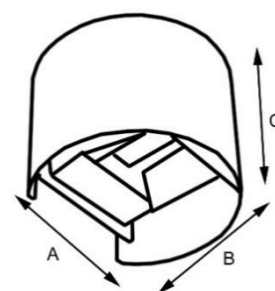

INDEX



A [mm]



B [mm]

C [mm]



	INDEX	ABC	Power	Lm	Tc[K]	Beam	A [mm]	B [mm]	C [mm]	Barcode
A	013073	Kreon LED	2x3 W	196 lm	4000 K	Zieleń mchu RAL 6005 Mechově zelená RAL 6005 Machovo zelená RAL 6005 Moss green RAL 6005	100	100	100	5902216799813
B	013072	Kreon LED	2x3 W	196 lm	4000 K	Czarny Černá Čierny Black	100	100	100	5902216799820
C	013634	Kreon LED	2x3 W	196 lm	4000 K	Biały bílá Bielá white	100	100	100	5902808804475
D	013635	Kreon LED	2x3 W	196 lm	4000 K	Antracytowy RAL 7016 antracitová RAL 7016 antracitová RAL 7016 anthracite RAL 7016	100	100	100	5902808804482
E	013070	Kreon LED	2x3 W	196 lm	4000 K	Zieleń mchu RAL 6005 Mechově zelená RAL 6005 Machovo zelená RAL 6005 Moss green RAL 6005	130	108	98	5902216799837
F	013071	Kreon LED	2x3 W	196 lm	4000 K	Czarny Černá Čierny Black	130	108	98	5902216799844



AC 230V



SMD LED



0-120°



NON-DIM



CRI/Ra



IP



IN&OUT

>80

40000 h

54

IN&OUT



Materiał / Materiál / Material

PL: aluminium

CZ: hliník

SK: hliník

EN: aluminium

Uwagi / Komentář / Komentáre

PL: Zasilacz w komplecie

CZ: Napájení je součástí dodávky

SK: Napájanie je súčasťou dodávky

EN: Power supply included

SURMUR



ARCHITEKTONICZNE LAMPY LED

CZ: LED svítidlo/ SK: LED svietidlo/ EN: LED lamp

A



B



C



D



INDEX



A [mm] B [mm] C [mm]



	INDEX				Tc[K]		A [mm]	B [mm]	C [mm]	
A	013075	Surmur LED	1x6 W	390 lm	4000 K	Zieleń mchu RAL 6005 Mechově zelená RAL 6005 Machovo zelená RAL 6005 Moss green RAL 6005	107	78	78	5902216799851
B	013074	Surmur LED	1x6 W	390 lm	4000 K	Czarny Černá Čierny Black	107	78	78	5902216799868
C	013076	Surmur LED	2x6 W	710 lm	4000 K	Zieleń mchu RAL 6005 Mechově zelená RAL 6005 Machovo zelená RAL 6005 Moss green RAL 6005	185	67	105	5902216799875
D	013077	Surmur LED	2x6 W	710 lm	4000 K	Czarny Černá Čierny Black	185	67	105	5902216799882



AC 230V



SMD LED



120°



NON-DIM



≥80



40000 h



54



IN&OUT



Materiał / Materiál / Material

PL: aluminium

CZ: hliník

SK: hliník

EN: aluminium

Uwagi / Komentář / Komentáre

PL: Zasilacz w komplecie

CZ: Napájení je součástí dodávky

SK: Napájanie je súčasťou dodávky

EN: Power supply included

Brólux

www.bowi.com.pl

GLOSS



ARCHITEKTONICZNE LAMPY LED

CZ: LED svítidlo/ SK: LED svietidlo/ EN: LED lamp



INDEX	ABC			Tc[K]		A [mm]	B [mm]	C [mm]	
013457	Gloss LED	9 W		4000 K	Czarna Černá Čierny Black	220	100	150	5902808802631

AC 230V	SMD LED		NON-DIM
	40000 h	54	IN&OUT
PIR			

Materiał / Material / Materiál

PL: aluminium

CZ: hliník

SK: hliník

EN: aluminium

Uwagi / Komentář / Komentáre

PL: Zasilacz w komplecie

CZ: Napájení je součástí dodávky

SK: Napájanie je súčasťou dodávky

EN: Power supply included

www.bowi.com.pl

ARCHITEKTONICZNE LAMPY LED

CZ: LED svítidlo/ SK: LED svietidlo/ EN: LED lamp



INDEX	ABC			Tc[K]		A [mm]	B [mm]	C [mm]	
013674	Kras LED	9 W	546 lm	4000 K	Czarny Černá Čierny Black	157	176	204	5902808804345

AC 230V	SMD LED	120°	NON-DIM
CRI/Ra	40000 h	IP	IN&OUT
PIR	CE	RoHS COMPLIANT	

Materiał / Material / Material

PL: Stal nierdzewna

CZ: Korozivzdorná ocel

SK: Nehrzdavejúca oceľ

EN: Stainless steel

Uwagi / Komentář / Komentáre

PL: Zasilacz w komplecie

CZ: Napájení je součástí dodávky

SK: Napájanie je súčasťou dodávky

EN: Power supply included

PRATO



ARCHITEKTONICZNE LAMPY LED

CZ: LED svítidlo/ SK: LED svietidlo/ EN: LED lamp



INDEX	ABC			Tc[K]		A [mm]	B [mm]	C [mm]	
013675	Prato LED	9 W	680	4000 K	Czarny Černá Čierny Black	69	47	235	5902808804352

AC 230V	SMD LED		NON-DIM
CRI/Ra	40000 h	54	IN&OUT
PIR			ROHS COMPLIANT

Materiał / Materiál / Material

PL: aluminium

CZ: hliník

SK: hliník

EN: aluminium

Uwagi / Komentář / Komentáre

PL: Zasilacz w komplecie

CZ: Napájení je součástí dodávky

SK: Napájanie je súčasťou dodávky

EN: Power supply included

www.bowi.com.pl

ARGON



OPRAWY ELEWACYJNE BEZ ŹRÓDŁA ŚWIATŁA

CZ: Svítidla bez zdroje světla / SK: Svietidlá bez zdroja svetla / EN: Luminaires without a light source



A



B

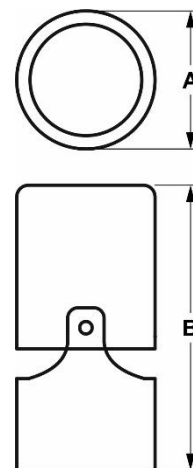

	INDEX	ABC		A [mm]	B [mm]	
A	012870	Argon	Biały biłá biłá white	75	116	5902216798267
B	012871	Argon	Czarny Černá Čierná Black	75	116	5902216798274



AC 230V



GU10

IP

54



IN&OUT



Materiał / Materiál / Materiál

PL: aluminium

CZ: hliník

SK: hliník

EN: aluminium

BroLux

www.bowi.com.pl

OPRAWY ELEWACYJNE BEZ ŹRÓDŁA ŚWIATŁA

CZ: Svítidla bez zdroje světla / SK: Svetidlá bez zdroja svetla / EN: Luminaires without a light source



	INDEX	ABC		A [mm]	B [mm]	C [mm]	
A	012796	Forti	Czarny Černá Čierná Black	68	92	80	5902216797871
B	012797	Forti	Szary Šedá Šedá Grey	68	92	80	5902216797888
C	012794	Forti	Czarny Černá Čierná Black	68	94	149	5902216797895
D	012798	Forti	Szary Šedá Šedá Grey	68	94	149	5902216797901

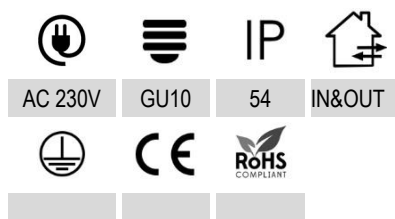

Materiał / Materiál / Material

PL: aluminium

CZ: hliník

SK: hliník

EN: aluminium

KILTOR



OPRAWY ELEWACYJNE BEZ ŹRÓDŁA ŚWIATŁA

CZ: Svítidla bez zdroje světla / SK: Svetidlá bez zdroja svetla / EN: Luminaires without a light source



INDEX
 ABC

 A [mm] B [mm] C [mm]

	INDEX	ABC		A [mm]	B [mm]	C [mm]	
A	012809	Kiltor	Czarny Černá Čierná Black	90	154	194	5902216797918
B	012808	Kiltor	Szary Šedá Šedá Grey	90	154	194	5902216797925
C	012806	Kiltor	Czarny Černá Čierná Black	90	154	298	5902216797932
D	012807	Kiltor	Szary Šedá Šedá Grey	90	154	298	5902216797949

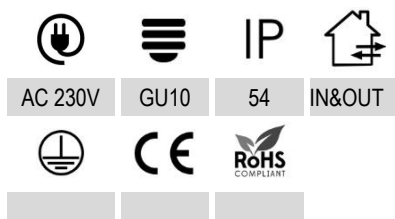

Materiał / Material / Material

PL: aluminium

CZ: hliník

SK: hliník

EN: aluminium

www.bowi.com.pl

OPRAWY ELEWACYJNE BEZ ŹRÓDŁA ŚWIATŁA

CZ: Svítidla bez zdroje světla / SK: Svetidlá bez zdroja svetla / EN: Luminaires without a light source



	INDEX	ABC		A [mm]	B [mm]	C [mm]	
A	012805	Kortek	Czarny Černá Čierná Black	100	102	156	5902216797918
B	012804	Kortek	Szary Šedá Šedá Grey	100	102	156	5902216797925
C	012802	Kortek	Czarny Černá Čierná Black	100	102	232	5902216797932
D	012803	Kortek	Szary Šedá Šedá Grey	100	102	232	5902216797949



AC 230V



GU10



54



IN&OUT



Materiał / Materiál / Materiál

PL: aluminium

CZ: hliník

SK: hliník

EN: aluminium

KORTI



OPRAWY ELEWACYJNE BEZ ŹRÓDŁA ŚWIATŁA

CZ: Svítidla bez zdroje světla / SK: Svietidlá bez zdroja svetla / EN: Luminaires without a light source



	INDEX	ABC		A [mm]	B [mm]	C [mm]	
A	012800	Korti	Czarny Černá	68	92	80	5902216798007
B	012799	Korti	Čierná Black	68	92	150	5902216798014

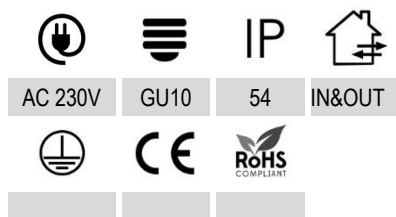

Materiał / Material / Material
PL: aluminium
CZ: hliník
SK: hliník
EN: aluminium



OPRAWY ELEWACYJNE BEZ ŹRÓDŁA ŚWIATŁA

CZ: Svítidla bez zdroje světla / SK: Svietidlá bez zdroja svetla / EN: Luminaires without a light source



	INDEX	ABC		A [mm]	B [mm]	C [mm]	
A	012801	Litek	Czarny Černá Čierná Black	110	95	165	5902216798021
B	012795	Litek	Čierná Black	109	102	234	5902216798038
C	013025	Litek	Szary Šedá Šedá Grey	110	95	165	5902216799493
D	013026	Litek	Šedá Grey	109	102	234	5902216799486

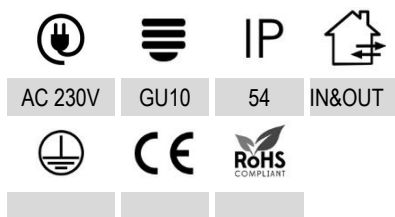

Materiał / Material / Material
PL: aluminium
CZ: hliník
SK: hliník
EN: aluminium

SANTA



OPRAWY ELEWACYJNE BEZ ŹRÓDŁA ŚWIATŁA

CZ: Svítidla bez zdroje světla / SK: Svetidlá bez zdroja svetla / EN: Luminaires without a light source



	INDEX			A [mm]	B [mm]	C [mm]	
A	013651	Santa	Czarny Černá Čierná Black	110	94	205	5902808805045
B	013117	Santa		110	94	307	5902216799981
C	013652	Santa	Antracytowy RAL 7016 antracitová RAL 7016 antracitová RAL 7016 anthracite RAL 7016	110	94	205	5902808805038
D	013650	Santa		110	94	307	5902808805052

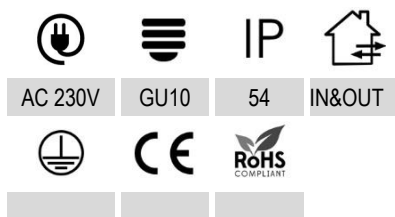

Materiał / Material / Material
 PL: aluminium
 CZ: hliník
 SK: hliník
 EN: aluminium



LULA



OPRAWY ELEWACYJNE BEZ ŹRÓDŁA ŚWIATŁA

CZ: Svítidla bez zdroje světla / SK: Svetidlá bez zdroja svetla / EN: Luminaires without a light source



A



B



C

	INDEX	ABC		A [mm]	B [mm]	
A	012813	Lula	Srebrny Sříbra Sříbrná Silver	88	310	5902216798045
B	012814	Lula		88	220	5902216798052
D	012815	Lula		88	445	5902216798083



AC 230V



E27

IP

54



IN&OUT



Materiał / Materiał / Material

PL: aluminium

CZ: hliník

SK: hliník

EN: aluminium

BroLux

www.bowi.com.pl

KETOR



OPRAWY ELEWACYJNE BEZ ŹRÓDŁA ŚWIATŁA

CZ: Svítidla bez zdroje světla / SK: Svietidlá bez zdroja svetla / EN: Luminaires without a light source



INDEX	ABC		A [mm]	B [mm]	C [mm]	
013668	Ketor	Czarny Černá Čierná Black	118	68	150	5902808804406

		IP	
AC 230V	GU10	54	IN&OUT
		CE	
	PIR		

Materiał / Materiál / Material

PL: aluminium

CZ: hliník

SK: hliník

EN: aluminium

BroLux

www.bowi.com.pl

OPRAWY ELEWACYJNE BEZ ŹRÓDŁA ŚWIATŁA

CZ: Svítidla bez zdroje světla / SK: Svietidlá bez zdroja svetla / EN: Luminaires without a light source



INDEX	ABC		A [mm]	B [mm]	C [mm]	
013671	Nordi	Czarny Černá Čierná Black	95	66	100	5902808804413

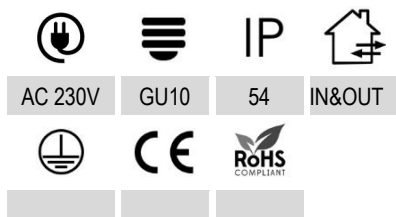

Materiał / Materiál / Material

PL: aluminium

CZ: hliník

SK: hliník

EN: aluminium

OPRAWY ELEWACYJNE BEZ ŹRÓDŁA ŚWIATŁA

CZ: Svítidla bez zdroje světla / SK: Svietidlá bez zdroja svetla / EN: Luminaires without a light source



INDEX	ABC		A [mm]	B [mm]	C [mm]	
013676	Oriko	Czarny Černá Čierná Black	270	182	120	5902808804420

		IP	
AC 230V	E27	54	IN&OUT
PIR			

Materiał / Materiál / Material

PL: aluminium

CZ: hliník

SK: hliník

EN: aluminium

REVOR



OPRAWY ELEWACYJNE BEZ ŹRÓDŁA ŚWIATŁA

CZ: Svítidla bez zdroje světla / SK: Svietidlá bez zdroja svetla / EN: Luminaires without a light source



INDEX	ABC		A [mm]	B [mm]	C [mm]	
013665	Revor	Czarny Černá Čierná Black	118	68	150	5902808804437

		IP	
AC 230V	GU10	54	IN&OUT
PIR			

Materiał / Materiál / Material

PL: aluminium

CZ: hliník

SK: hliník

EN: aluminium

BroLux

www.bowi.com.pl

SAILOR



OPRAWY ELEWACYJNE BEZ ŹRÓDŁA ŚWIATŁA

CZ: Svítidla bez zdroje světla / SK: Svetidlá bez zdroja svetla / EN: Luminaires without a light source



	INDEX	ABC		A [mm]	B [mm]	C [mm]	
A	013530	Sailor	Czarny Černá Čierná Black	75	125	390	5902808803331
B	013531	Sailor	Antracytowy RAL 7016 antracitová RAL 7016 antracitová RAL 7016 anthracite RAL 7016	75	125	390	5902808803348

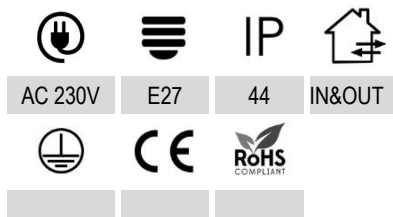

Materiał / Material / Material

PL: aluminium

CZ: hliník

SK: hliník

EN: aluminium

BroLux

www.bowi.com.pl

OPRAWY ELEWACYJNE BEZ ŹRÓDŁA ŚWIATŁA

CZ: Svítidla bez zdroje světla / SK: Svetidlá bez zdroja svetla / EN: Luminaires without a light source



A



B

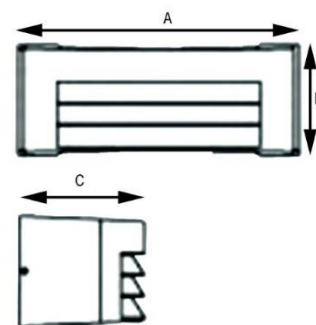

	INDEX	ABC			A [mm]	B [mm]	C [mm]	
A	013535	Oliana	Czarny Černá Čierna Black		290	113	129	5902808803539
B	013536	Oliana	Antracytowy RAL 7016 antracitová RAL 7016 antracitová RAL 7016 anthracite RAL 7016		290	113	129	5902808803546



AC 230V



E27

IP

54



IN&OUT



Materiał / Materiál / Material

PL: aluminium

CZ: hliník

SK: hliník

EN: aluminium

Uwagi / Komentář / Komentáre

PL: Zasilacz w komplecie

CZ: Napájení je součástí dodávky

SK: Napájanie je súčasťou dodávky

EN: Power supply included

SURVA



OPRAWY ELEWACYJNE BEZ ŹRÓDŁA ŚWIATŁA

CZ: Svítidla bez zdroje světla / SK: Svetidlá bez zdroja svetla / EN: Luminaires without a light source

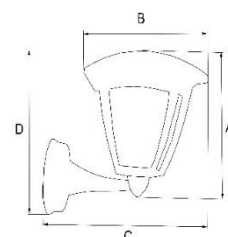

A

B

C

	INDEX	ABC		A [mm]	B [mm]	C [mm]	D [mm]	
A	013078	Surva	Czarny Černá Čierna Black	210	170	215	240	5902216799721
B	013112	Surva		210	170	215	250	5902216799936
C	013685	Surva		210	170	215		5902808804994



AC 230V



E27

IP

44



IN&OUT



Materiał / Materiál / Material

PL: aluminium

CZ: hliník

SK: hliník

EN: aluminium

Brolux

www.bowi.com.pl

ODINA



OPRAWY ELEWACYJNE BEZ ŹRÓDŁA ŚWIATŁA

CZ: Svítidla bez zdroje světla / SK: Svietidlá bez zdroja svetla / EN: Luminaires without a light source

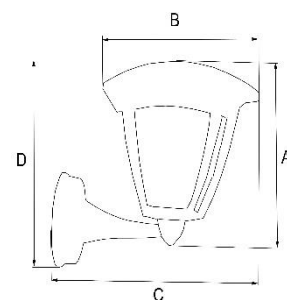

INDEX	ABC		A [mm]	B [mm]	C [mm]	D [mm]	
013113	Odina		210	170	215	240	5902216799943



AC 230V



E27

IP



IN&OUT



Materiał / Materiál / Material

PL: aluminium

CZ: hliník

SK: hliník

EN: aluminium

Uwagi / Komentář / Komentáre

PL: Zasilacz w komplecie

CZ: Napájení je součástí dodávky

SK: Napájanie je súčasťou dodávky

EN: Power supply included

BroLux

MALIA



OPRAWY ELEWACYJNE BEZ ŹRÓDŁA ŚWIATŁA

CZ: Svítidla bez zdroje světla / SK: Svietidlá bez zdroja svetla / EN: Luminaires without a light source

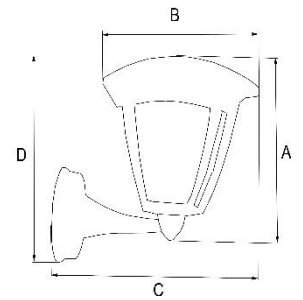

INDEX	ABC		A [mm]	B [mm]	C [mm]	D [mm]	
013114	Malia		210	175	215	240	5902216799950



AC 230V



E27

IP



IN&OUT



Materiał / Materiál / Materiál

PL: aluminium

CZ: hliník

SK: hliník

EN: aluminium

Uwagi / Komentář / Komentáre

PL: Zasilacz w komplecie

CZ: Napájení je součástí dodávky

SK: Napájanie je súčasťou dodávky

EN: Power supply included

BroLux

RINA



OPRAWY ELEWACYJNE BEZ ŹRÓDŁA ŚWIATŁA

CZ: Svítidla bez zdroje světla / SK: Svetidlá bez zdroja svetla / EN: Luminaires without a light source

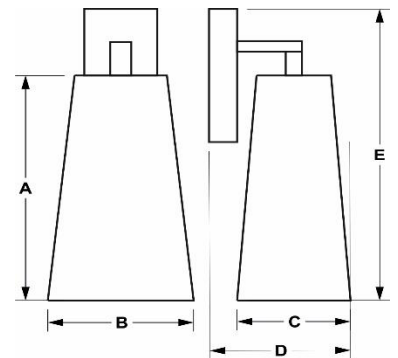

INDEX	ABC		A [mm]	B [mm]	C [mm]	D [mm]	E [mm]	
013115	Rina		293	170	140	350	165	5902216799967



AC 230V



E27

IP



IN&OUT



Materiał / Materiál / Materiál

PL: aluminium

CZ: hliník

SK: hliník

EN: aluminium

Uwagi / Komentář / Komentáre

PL: Zasilacz w komplecie

CZ: Napájení je součástí dodávky

SK: Napájanie je súčasťou dodávky

EN: Power supply included

Brolux

OPRAWY ELEWACYJNE BEZ ŹRÓDŁA ŚWIATŁA

CZ: Svítidla bez zdroje světla / SK: Svetidlá bez zdroja svetla / EN: Luminaires without a light source

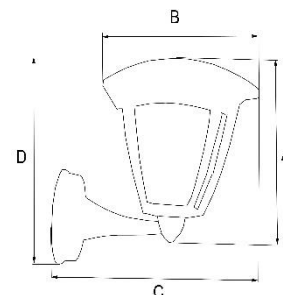

INDEX	ABC		A [mm]	B [mm]	C [mm]	D [mm]	
013116	Wilda	Czarny Černá Čierná Black	260	210	250	260	5902216799974



AC 230V



E27

IP



IN&OUT



Materiał / Materiál / Material

PL: aluminium

CZ: hliník

SK: hliník

EN: aluminium

Uwagi / Komentář / Komentáre

PL: Zasilacz w komplecie

CZ: Napájení je součástí dodávky

SK: Napájanie je súčasťou dodávky

EN: Power supply included

OPRAWY ELEWACYJNE BEZ ŹRÓDŁA ŚWIATŁA

CZ: Svítidla bez zdroje světla / SK: Svetidlá bez zdroja svetla / EN: Luminaires without a light source

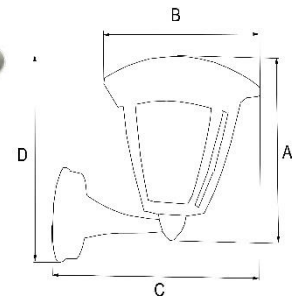

INDEX	ABC		A [mm]	B [mm]	C [mm]	D [mm]	
013118	ELENI		155	240	260	180	5902216799974



AC 230V



E27

IP



IN&OUT



Materiał / Materiál / Materiál

PL: aluminium

CZ: hliník

SK: hliník

EN: aluminium

Uwagi / Komentář / Komentáre

PL: Zasilacz w komplecie

CZ: Napájení je součástí dodávky

SK: Napájanie je súčasťou dodávky

EN: Power supply included

ADDA



OPRAWY ELEWACYJNE BEZ ŹRÓDŁA ŚWIATŁA

CZ: Svítidla bez zdroje světla / SK: Svetidlá bez zdroja svetla / EN: Luminaires without a light source

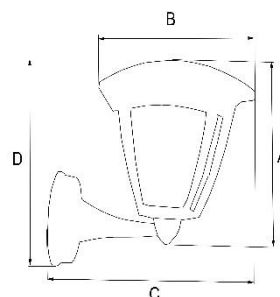

INDEX			A [mm]	B [mm]	C [mm]	D [mm]	
013583	ADDA	Czarny Černá Čierná Black	210	210	250	210	5902808804840



AC 230V



E27

IP



IN&OUT



Materiał / Materiál / Material

PL: aluminium

CZ: hliník

SK: hliník

EN: aluminium

Uwagi / Komentář / Komentáre

PL: Zasilacz w komplecie

CZ: Napájení je součástí dodávky

SK: Napájanie je súčasťou dodávky

EN: Power supply included

BroLux

www.bowi.com.pl

BARD



OPRAWY ELEWACYJNE BEZ ŹRÓDŁA ŚWIATŁA

CZ: Svítidla bez zdroje světla / SK: Svietidlá bez zdroja svetla / EN: Luminaires without a light source

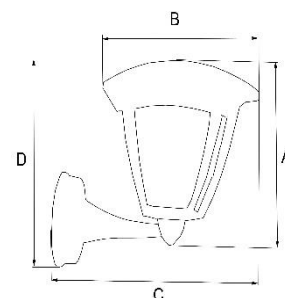

INDEX			A [mm]	B [mm]	C [mm]	D [mm]	
013584	BARD	Czarny Černá Čierná Black	235	305	370	350	5902808804857



AC 230V



E27

IP



IN&OUT



Materiał / Materiál / Material

PL: aluminium

CZ: hliník

SK: hliník

EN: aluminium

Uwagi / Komentář / Komentáre

PL: Zasilacz w komplecie

CZ: Napájení je součástí dodávky

SK: Napájanie je súčasťou dodávky

EN: Power supply included

BroLux

OPRAWY ELEWACYJNE BEZ ŹRÓDŁA ŚWIATŁA

CZ: Svítidla bez zdroje světla / SK: Svietidlá bez zdroja svetla / EN: Luminaires without a light source

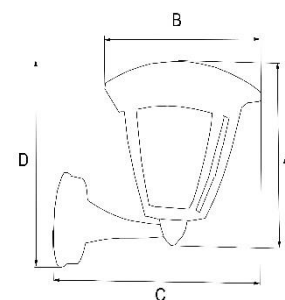

INDEX			A [mm]	B [mm]	C [mm]	D [mm]	
013588	NILDA	Czarny Černá Čierna Black	290	250	365	400	5902808804840



AC 230V



E27

IP



IN&OUT



Materiał / Materiál / Material

PL: aluminium

CZ: hliník

SK: hliník

EN: aluminium

Uwagi / Komentář / Komentáre

PL: Zasilacz w komplecie

CZ: Napájení je součástí dodávky

SK: Napájanie je súčasťou dodávky

EN: Power supply included

TAMA



OPRAWY ELEWACYJNE BEZ ŹRÓDŁA ŚWIATŁA

CZ: Svítidla bez zdroje světla / SK: Svietidlá bez zdroja svetla / EN: Luminaires without a light source

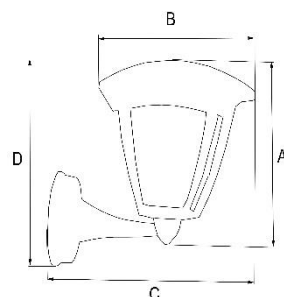

INDEX	ABC		A [mm]	B [mm]	C [mm]	D [mm]	
013590	TAMA		260	185	285	380	5902808804949



AC 230V



E27

IP



IN&OUT



Materiał / Materiál / Materiál

PL: aluminium

CZ: hliník

SK: hliník

EN: aluminium

Uwagi / Komentář / Komentáre

PL: Zasilacz w komplecie

CZ: Napájení je součástí dodávky

SK: Napájanie je súčasťou dodávky

EN: Power supply included

BroLux

ULAN



OPRAWY ELEWACYJNE BEZ ŹRÓDŁA ŚWIATŁA

CZ: Svítidla bez zdroje světla / SK: Svetidlá bez zdroja svetla / EN: Luminaires without a light source

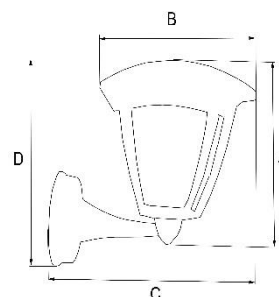

INDEX			A [mm]	B [mm]	C [mm]	D [mm]	
013593	ULAN	Czarny Černá Čierná Black	305	180	240	320	5902808804963



AC 230V



E27

IP



IN&OUT



Materiał / Materiál / Material

PL: aluminium

CZ: hliník

SK: hliník

EN: aluminium

Uwagi / Komentář / Komentáre

PL: Zasilacz w komplecie

CZ: Napájení je součástí dodávky

SK: Napájanie je súčasťou dodávky

EN: Power supply included

BroLux

ZUNA



OPRAWY ELEWACYJNE BEZ ŹRÓDŁA ŚWIATŁA

CZ: Svítidla bez zdroje světla / SK: Svetidlá bez zdroja svetla / EN: Luminaires without a light source

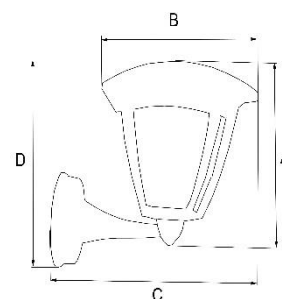

INDEX	ABC		A [mm]	B [mm]	C [mm]	D [mm]	
013582	ZUNA		235	280	385	325	5902808804987



AC 230V



E27

IP



IN&OUT



Materiał / Materiál / Material

PL: aluminium

CZ: hliník

SK: hliník

EN: aluminium

Uwagi / Komentář / Komentáre

PL: Zasilacz w komplecie

CZ: Napájení je součástí dodávky

SK: Napájanie je súčasťou dodávky

EN: Power supply included

Brolux

EDINA



OPRAWY ELEWACYJNE BEZ ŹRÓDŁA ŚWIATŁA

CZ: Svítidla bez zdroje světla / SK: Svetidlá bez zdroja svetla / EN: Luminaires without a light source

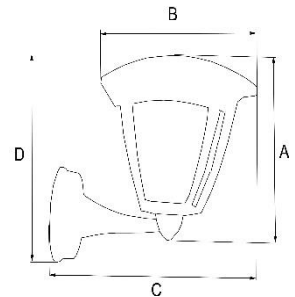

INDEX			A [mm]	B [mm]	C [mm]	D [mm]	
013595	EDINA	Czarny Černá Čierná Black	205	195	235	215	5902808804864



AC 230V



E27

IP



IN&OUT



Materiał / Materiál / Material

PL: aluminium

CZ: hliník

SK: hliník

EN: aluminium

Uwagi / Komentář / Komentáre

PL: Zasilacz w komplecie

CZ: Napájení je součástí dodávky

SK: Napájanie je súčasťou dodávky

EN: Power supply included

BroLux

ELGIN



OPRAWY ELEWACYJNE BEZ ŹRÓDŁA ŚWIATŁA

CZ: Svítidla bez zdroje světla / SK: Svetidlá bez zdroja svetla / EN: Luminaires without a light source

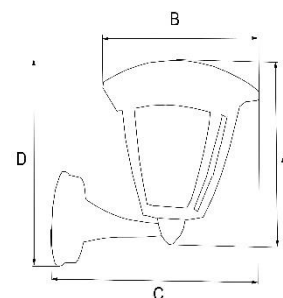

INDEX	ABC		A [mm]	B [mm]	C [mm]	D [mm]	
013596	ELGIN	Czarny Černá Čierná Black	207	195	235	210	5902808804871



AC 230V



E27

IP



IN&OUT



Materiał / Materiál / Material

PL: aluminium

CZ: hliník

SK: hliník

EN: aluminium

Uwagi / Komentář / Komentáre

PL: Zasilacz w komplecie

CZ: Napájení je součástí dodávky

SK: Napájanie je súčasťou dodávky

EN: Power supply included

Brolux

ZALIKA



OPRAWY ELEWACYJNE BEZ ŹRÓDŁA ŚWIATŁA

CZ: Svítidla bez zdroje světla / SK: Svetidlá bez zdroja svetla / EN: Luminaires without a light source

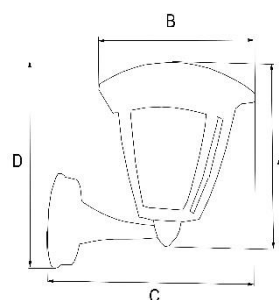

INDEX			A [mm]	B [mm]	C [mm]	D [mm]	
013594	ZALIKA	Czarny Černá Čierná Black	178	240	260	182	5902808804970



AC 230V



E27

IP



IN&OUT



Materiał / Materiál / Material

PL: aluminium

CZ: hliník

SK: hliník

EN: aluminium

Uwagi / Komentář / Komentáre

PL: Zasilacz w komplecie

CZ: Napájení je součástí dodávky

SK: Napájanie je súčasťou dodávky

EN: Power supply included

BroLux

FAYOLA



OPRAWY ELEWACYJNE BEZ ŹRÓDŁA ŚWIATŁA

CZ: Svítidla bez zdroje světla / SK: Svetidlá bez zdroja svetla / EN: Luminaires without a light source

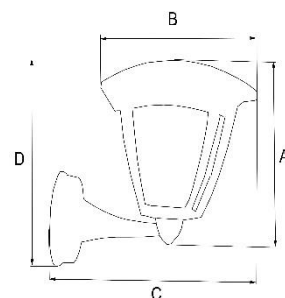

INDEX	ABC		A [mm]	B [mm]	C [mm]	D [mm]	
013597	FAYOLA	Czarny Černá Čierná Black	170	178	201	185	5902808804888



AC 230V



E27

IP



IN&OUT



Materiał / Materiál / Material

PL: aluminium

CZ: hliník

SK: hliník

EN: aluminium

Uwagi / Komentář / Komentáre

PL: Zasilacz w komplecie

CZ: Napájení je součástí dodávky

SK: Napájanie je súčasťou dodávky

EN: Power supply included

BroLux

OPRAWY ELEWACYJNE BEZ ŹRÓDŁA ŚWIATŁA

CZ: Svítidla bez zdroje světla / SK: Svetidlá bez zdroja svetla / EN: Luminaires without a light source

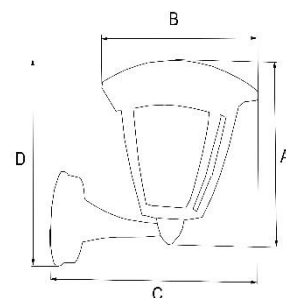

INDEX			A [mm]	B [mm]	C [mm]	D [mm]	
013597	GALINI	Czarny Černá Čierná Black	167	178	201	182	5902808804888



AC 230V



E27

IP



IN&OUT



Materiał / Materiál / Material

PL: aluminium

CZ: hliník

SK: hliník

EN: aluminium

Uwagi / Komentář / Komentáre

PL: Zasilacz w komplecie

CZ: Napájení je součástí dodávky

SK: Napájanie je súčasťou dodávky

EN: Power supply included

LAVINA



OPRAWY ELEWACYJNE BEZ ŹRÓDŁA ŚWIATŁA

CZ: Svítidla bez zdroje světla / SK: Svetidlá bez zdroja svetla / EN: Luminaires without a light source

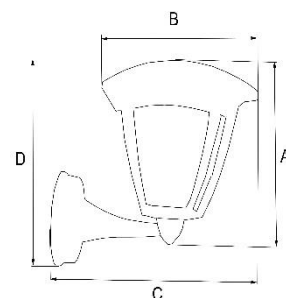

INDEX	ABC		A [mm]	B [mm]	C [mm]	D [mm]	
013597	LAVINA	Czarny Černá Čierná Black	220	195	235	300	5902808804888



AC 230V



E27

IP



IN&OUT



Materiał / Materiál / Material

PL: aluminium

CZ: hliník

SK: hliník

EN: aluminium

Uwagi / Komentář / Komentáre

PL: Zasilacz w komplecie

CZ: Napájení je součástí dodávky

SK: Napájanie je súčasťou dodávky

EN: Power supply included

BroLux

LEILA



OPRAWY ELEWACYJNE BEZ ŹRÓDŁA ŚWIATŁA

CZ: Svítidla bez zdroje světla / SK: Svetidlá bez zdroja svetla / EN: Luminaires without a light source

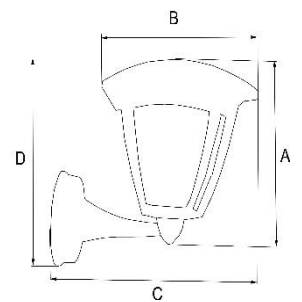

INDEX	ABC		A [mm]	B [mm]	C [mm]	D [mm]	
013587	LEILA	Czarny Černá Čierna Black	230	240	278	303	5902808804918



AC 230V



E27

IP



IN&OUT



Materiał / Materiál / Material

PL: aluminium

CZ: hliník

SK: hliník

EN: aluminium

Uwagi / Komentář / Komentáre

PL: Zasilacz w komplecie

CZ: Napájení je součástí dodávky

SK: Napájanie je súčasťou dodávky

EN: Power supply included

BroLux

TALISA



OPRAWY ELEWACYJNE BEZ ŹRÓDŁA ŚWIATŁA

CZ: Svítidla bez zdroje světla / SK: Svietidlá bez zdroja svetla / EN: Luminaires without a light source

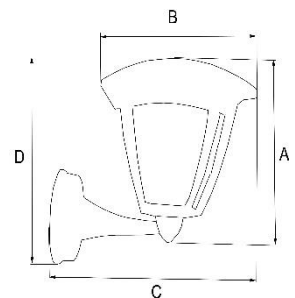

INDEX	ABC		A [mm]	B [mm]	C [mm]	D [mm]	
013591	TALISA	Czarny Černá Čierná Black	260	250	330	370	5902808804932



AC 230V



E27

IP



IN&OUT



Materiał / Materiál / Material

PL: aluminium

CZ: hliník

SK: hliník

EN: aluminium

Uwagi / Komentář / Komentáre

PL: Zasilacz w komplecie

CZ: Napájení je součástí dodávky

SK: Napájanie je súčasťou dodávky

EN: Power supply included

BroLux

TANGIA



OPRAWY ELEWACYJNE BEZ ŹRÓDŁA ŚWIATŁA

CZ: Svítidla bez zdroje světla / SK: Svetidlá bez zdroja svetla / EN: Luminaires without a light source

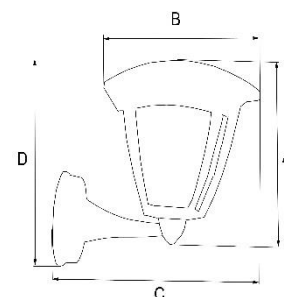

INDEX			A [mm]	B [mm]	C [mm]	D [mm]	
013592	TANGIA	Czarny Černá Čierná Black	260	250	425	360	5902808804956



AC 230V



E27

IP



IN&OUT



Materiał / Materiál / Material

PL: aluminium

CZ: hliník

SK: hliník

EN: aluminium

Uwagi / Komentář / Komentáre

PL: Zasilacz w komplecie

CZ: Napájení je součástí dodávky

SK: Napájanie je súčasťou dodávky

EN: Power supply included

BroLux

SANTIGO



OPRAWY ELEWACYJNE BEZ ŹRÓDŁA ŚWIATŁA

CZ: Svítidla bez zdroje světla / SK: Svetidlá bez zdroja svetla / EN: Luminaires without a light source



INDEX	ABC		A [mm]	B [mm]	C [mm]	
008687	SANTIGO	Czarny Černá Čierna Black	205	200	245	5902216768031



AC 230V



E27

IP

44



IN&OUT



Materiał / Materiál / Material

PL: aluminium

CZ: hliník

SK: hliník

EN: aluminium

Uwagi / Komentář / Komentáre

PL: Zasilacz w komplecie

CZ: Napájení je součástí dodávky

SK: Napájanie je súčasťou dodávky

EN: Power supply included

BroLux

www.bowi.com.pl

OPRAWY ELEWACYJNE BEZ ŹRÓDŁA ŚWIATŁA

CZ: Svítidla bez zdroje světla / SK: Svetidlá bez zdroja svetla / EN: Luminaires without a light source



INDEX			A [mm]	 B [mm]	C [mm]	
013306	ORINS	Czarny Černá Čierna Black	141	90	180	5902808804635



AC 230V



E27

IP

44



IN&OUT



Materiał / Materiál / Materiál

PL: aluminium

CZ: hliník

SK: hliník

EN: aluminium

Uwagi / Komentář / Komentáre

PL: Zasilacz w komplecie

CZ: Napájení je součástí dodávky

SK: Napájanie je súčasťou dodávky

EN: Power supply included

JULIA



OPRAWY ELEWACYJNE BEZ ŹRÓDŁA ŚWIATŁA

CZ: Svítidla bez zdroje světla / SK: Svetidlá bez zdroja svetla / EN: Luminaires without a light source



INDEX			A [mm]	 B [mm]	C [mm]	
009476	JULIA	Czarny Černá Čierna Black	175	130	200	5902216768185



AC 230V



E27

IP



IN&OUT



Materiał / Materiál / Material

PL: aluminium

CZ: hliník

SK: hliník

EN: aluminium

Uwagi / Komentář / Komentáre

PL: Zasilacz w komplecie

CZ: Napájení je součástí dodávky

SK: Napájanie je súčasťou dodávky

EN: Power supply included

BroLux

OPRAWY ŚCIENNE BEZ ŹRÓDŁA ŚWIATŁA



OPRAWY ELEWACYJNE BEZ ŹRÓDŁA ŚWIATŁA

CZ: Svítidla bez zdroje světla / SK: Svietidlá bez zdroja svetla / EN: Luminaires without a light source



A



B



C



D



E



F



INDEX



IP



A	1310	Falin	Czarny Černá Čierná Black	E27	IP54	5902216771093
B	5942	Gallun		E27	IP54	5902216718968
C	253	Hardin		E27	IP54	5902216718975
D	6442	Nakita		E27	IP54	5902216770225
E	2035	Niles		GU10	IP54	5902216719040
F	002593	Zorin		GU10	IP54	5902216719200



AC 230V



IN&OUT



Materiał / Materiál / Materiál

PL: aluminium

CZ: hliník

SK: hliník

EN: aluminum

BroLux

OPRAWY DOGRUNTOWE

CZ: svítidlo dogruntowe / SK: svetidlo dogruntowe / EN: In ground light



A



B

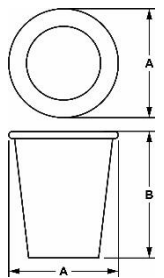

	INDEX	ABC	⚡	💡 Lm	Tc[K]	🔍	A [mm]	B [mm]	📊
A	010452	Pelia LED	10 W	600 lm	3500 K	Srebrny Stříbrná stříbrná silver	160	93	5902216714410
A	010453	Pelia LED	10 W	600 lm	4500 K		160	93	5902216711969
B	013670	Pelia LED	20 W	1659 lm	4000 K		210	110	5902808804338
B	010455	Pelia LED	30 W	18000 lm	3500 K		250	97	5902216711976
B	010454	Pelia LED	30 W	18000 lm	4500 K		250	97	5902216711983

AC 230V	COB LED	120°	NON-DIM
>75	40000 h	68	IN&OUT

Materiał / Materiał / Material

PL: aluminium

CZ: hliník

SK: hliník

EN: aluminum

Uwagi / Komentář / Komentáre

PL: Zasilacz w komplecie

CZ: Napájení je součástí dodávky

SK: Napájanie je súčasťou dodávky

EN: Power supply included

OPRAWY DOGRUNTOWE

CZ: svítidlo dogruntowe / SK: svetidlo dogruntowe / EN: In ground light



A



B



C



D



E

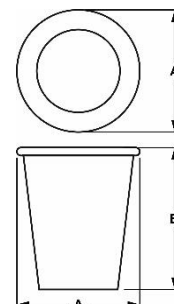

INDEX



A [mm] B [mm]



	INDEX	ABC	Power	lm/W	lm	Tc [K]	Color	A [mm]	B [mm]	Barcode
A	007481	Sibar LED	3 W	70 lm/W	210 lm	3500 K		100	78	5902216706750
A	007484	Sibar LED	3 W	70 lm/W	210 lm	4500 K		100	78	5902216714427
A	011376	Sibar LED	3 W	70 lm/W	210 lm	6500 K		100	78	5902216714434
A	010458	Sibar LED	3 W			RGB		100	78	5902216758346
B	007491	Sibar LED	5 W	70 lm/W	350 lm	3500 K		120	92	5902216711990
B	007487	Sibar LED	5 W	70 lm/W	350 lm	4500 K		120	92	5902216723764
B	010457	Sibar LED	5 W			RGB		120	92	5902216739123
C	007498	Sibar LED	7 W	70 lm/W	490 lm	3500 K		120	92	5902216712003
C	007502	Sibar LED	7 W	70 lm/W	490 lm	4500 K		120	92	5902216723771
C	007668	Sibar LED	7 W			Czerwony	Srebrny Stieborný stříbrná silver	120	92	5902216758353
C	007851	Sibar LED	7 W			Niebieski		120	92	5902216739130
C	010456	Sibar LED	7 W			RGB		120	92	5902216739147
D	007535	Sibar LED	9 W	70 lm/W	630 lm	3500 K		150	92	5902216714441
D	007529	Sibar LED	9 W	70 lm/W	630 lm	4500 K		150	92	5902216714458
E	007536	Sibar LED	12 W	70 lm/W	840 lm	3500 K		180	94	5902216712010
E	007595	Sibar LED	12 W	70 lm/W	840 lm	4500 K		181	94	5902216723788
E	011410	Sibar LED	12 W			RGB		182	94	5902216758360



AC 230V



Power LED



30°



NON-DIM



>75



40000 h



68



IN&OUT



RoHS COMPLIANT



CE

Uwagi / Komentář / Komentáre

PL: Zasilacz w komplecie

CZ: Napájení je součástí dodávky

SK: Napájanie je súčasťou dodávky

EN: Power supply included

Materiał / Materiál / Material

PL: aluminium

CZ: hliník

SK: hliník

EN: aluminum

Optymalne warunki eksploatacji:

Optimální provozní podmínky:

Optimálne prevádzkové podmienky:

Optimal operating conditions:

PL: temperatura.: od -10°C do +25°C

wilgotność: <85% ciśnienie: 690-1060 hPa

CZ: teplota: od -10 ° C do + 25 ° C

vlhkost: <85% tlak: 690-1060 hPa

SK: teplota: od -10 ° C do + 25 ° C

vlhkost: <85% tlak: 690-1060 hPa

EN: temperature: from -10 ° C to + 25 ° C

humidity: <85% pressure: 690-1060 hPa

BroLux

OPRAWY NAJAZDOWE BEZ ŹRÓDŁA ŚWIATŁA

OPRAWY NAJAZDOWE

CZ: Svítidla bez zdroje světla / SK: Svietidlá bez zdroja svetla / EN: Luminaires without a light source







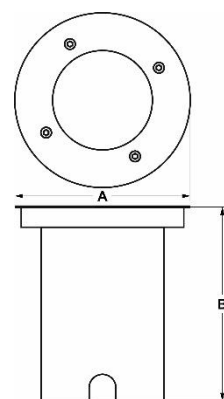

A



B



	 INDEX	 ABC		 A [mm]	 B [mm]	
A	012811		Czarny Černá Čierná Black	108	144	5902216798069
B	012812			108	144	5902216798076

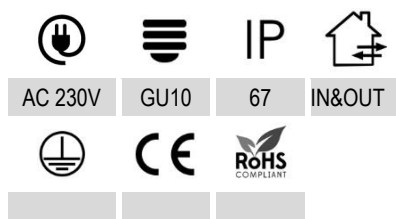

Materiał / Material / Material
PL: aluminium
CZ: hliník
SK: hliník
EN: aluminium



SALSA



SŁUPKI LED

CZ: LED Sloupky / SK: LED stĺpiky / EN: LED posts



A

INDEX



ABC



9 W



540 lm



Tc[K]



Czarny
Černá
Čierna
Black



A
[mm]

B
[mm]



0 125480 788072

	INDEX	ABC	9 W	540 lm	3000 K	Czarny Černá Čierna Black	A [mm]	B [mm]	0 125480 788072
A	002805	Salsa LED	9 W	540 lm	3000 K		120	300	5902216770652
B	002657	Salsa LED	9 W	540 lm	3000 K		120	500	5902216719620
C	013747	Salsa LED	9 W	540 lm	3000 K		120	800	5902808805458



AC 230V



SMD LED



NON-DIM



IN&OUT



80



40000 h



54



Materiał / Materiál / Material

PL: aluminium

CZ: hliník

SK: hliník

EN: aluminium

Uwagi / Komentář / Komentáre

PL: Zasilacz w komplecie

CZ: Napájení je součástí dodávky

SK: Napájanie je súčasťou dodávky

EN: Power supply included



SŁUPKI LED

CZ: LED Sloupky / SK: LED stĺpiky / EN: LED posts



A



B



C

	INDEX			Lm			A [mm]	
A	6333	Sanam LED	6 W	540 lm	3500 K	Czarny Černá Čierná Black	300	5902216719583
B	5749	Sanam LED	6 W	520 lm	3500 K		500	5902216719590
C	005269	Sanam LED	6 W	540 lm	3500 K		800	5902216719637



AC 230V

SMD LED

NON-DIM

IN&OUT



80

40000 h

54



Materiał / Materiál / Material

PL: aluminium

CZ: hliník

SK: hliník

EN: aluminium

Uwagi / Komentář / Komentáre

PL: Zasilacz w komplecie

CZ: Napájení je součástí dodávky

SK: Napájanie je súčasťou dodávky

EN: Power supply included

SŁUPKI LED



SŁUPKI LED

CZ: LED Sloupky / SK: LED stĺpiky / EN: LED posts



INDEX



Tc[K]



IP



HEIGHT



A	000975	Ayron LED	6,5 W	420 lm	3000 K	Czarny Černá Čierná Black	40°	IP54	SMD LED	800mm	5902216771079
C	002243	Camee LED	3*1 W	120 lm	4000 K		60°	IP54	Power LED	720×120 mm	5902216770966
D	001932	Halen LED	6*2 W	300 lm	4000 K		120°	IP54	Power LED	Ø130×600 mm	5902216770829
E	000187	Idan LED	1*7 W	340 lm	4000 K		100°	IP54	Power LED	Ø210×650 mm	5902216770812
F	003198	Laima LED	6 W	420 lm	3000 K		100°	IP54	SMD LED	156×600×138 mm	5902216770751
G	275	Malin LED	6 W	480 lm	3500 K		120°	IP54	Power LED	600×200 mm	5902216770683
H	367	Orik LED	4 W	800 lm	3500 K		120°	IP54	SMD LED	190×68 mm	5902216719057
I	005141	Sanders LED	6 W	520 lm	3000 K		120°	IP54	SMD LED	500 mm	5902216717039
J	5745	Sandor LED	6 W	520 lm	3500 K		120°	IP54	SMD LED	500 mm	5902216770577
K	5978	Saven LED	6 W	520 lm	3000 K		120°	IP54	SMD LED	500 mm	5902216717046
L	5742	Savio LED	6 W	520 lm	3500 K		120°	IP54	SMD LED	800 mm	5902216770560
M	3519	Sedge LED	6 W	670 lm	3500 K		50°	IP54	Power LED	300 mm	5902216770515
N	002805	Waels LED	5 W	400 lm	3500 K		120°	IP54	Power LED	108×108 mm	5902216719033
O	7026	Yanko LED	1×7 W	450 lm	4500 K		50°	IP54	Power LED	Ø90×160 mm	5902216770447



AC 230V



NON-DIM



IN&OUT



CRi(Ra)



40000 h



Materiał / Materiál / Materiál

PL: aluminium

CZ: hliník

SK: hliník

EN: aluminum

Uwagi / Komentář / Komentáre

PL: Zasilacz w komplecie

CZ: Napájení je součástí dodávky

SK: Napájanie je súčasťou dodávky

EN: Power supply included

BroLux

www.bowi.com.pl

SŁUPKI LED



SŁUPKI LED

CZ: LED Sloupky / SK: LED stĺpiky / EN: LED posts



KASPIANUS



SŁUPKI LED

CZ: LED Sloupky / SK: LED stĺpiky / EN: LED posts



INDEX	ABC			Tc[K]		A [mm]	B [mm]	
007472	Kaspianus LED	13 W		3000 K	Czarny Černá Čierná Black	135	500	5902216719842

AC 230V	SMD LED	NON-DIM	IN&OUT
80	40000 h	54	

Materiał / Materiál / Material

PL: aluminium
 CZ: hliník
 SK: hliník
 EN: aluminium

Uwagi / Komentář / Komentáre

PL: Zasilacz w komplecie
 CZ: Napájení je součástí dodávky
 SK: Napájanie je súčasťou dodávky
 EN: Power supply included



PLESA



SŁUPKI LED

CZ: LED Sloupky / SK: LED stĺpiky / EN: LED posts



INDEX				Tc[K]		A [mm]	B [mm]	
006949	Plesa LED	7 W		3000 K	Czarny Černá Čierná Black	70	500	5902808804659

AC 230V	SMD LED	NON-DIM	IN&OUT
80	40000 h	54	

Materiał / Materiál / Material

PL: aluminium

CZ: hliník

SK: hliník

EN: aluminium

Uwagi / Komentář / Komentáre

PL: Zasilacz w komplecie

CZ: Napájení je součástí dodávky

SK: Napájanie je súčasťou dodávky

EN: Power supply included



SŁUPKI BEZ ŹRÓDŁA ŚWIATŁA

CZ: Sloupky bez zdroje světla / SK: Stĺpiky bez zdroja svetla / EN: Posts without a light source



	INDEX	ABC		E27	A [mm]	B [mm]	C [mm]	Barcode
A	012815	Lula	Srebrny Stříbra Sříbrná Silver	E27	445	88	88	5902216798083
B	000095	Seeman	Czarny Černá Čierná Black	E27	500	130	120	5902216719606
C	000114	Segar		E27	500	105	100	5902216719613

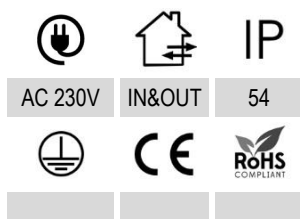

Materiał / Materiál / Material
 PL: stalowa nierdzewna
 CZ: nerezová ocel
 SK: nerezovej ocele
 EN: steel plate

Uwagi / Komentář / Komentáre
 PL: Zasilacz w komplecie
 CZ: Napájení je součástí dodávky
 SK: Napájanie je súčasťou dodávky
 EN: Power supply included

SURVA



SŁUPKI BEZ ŹRÓDŁA ŚWIATŁA

CZ: Sloupky bez zdroje světla / SK: Stĺpiky bez zdroja svetla / EN: Posts without a light source

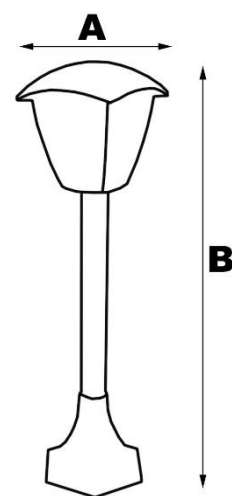

INDEX			A [mm]	B [mm]	
5121	Surva	Czarny Černá Čierná Black	170	930	5902808804154



E27



IN&OUT

IP

54



Materiał / Materiál / Material

PL: aluminium

CZ: hliník

SK: hliník

EN: aluminium

Uwagi / Komentář / Komentáre

PL: Zasilacz w komplecie

CZ: Napájení je součástí dodávky

SK: Napájanie je súčasťou dodávky

EN: Power supply included

BroLux

www.bowi.com.pl

KETOR



SŁUPKI BEZ ŹRÓDŁA ŚWIATŁA

CZ: Sloupky bez zdroje světla / SK: Stĺpiky bez zdroja svetla / EN: Posts without a light source



INDEX	ABC		A [mm]	B [mm]	C [mm]	
013669	Ketor	Czarny Černá Čierná Black	113	70	495	5902808804444

		IP
GU10	IN&OUT	54

Materiał / Materiál / Material

PL: aluminium

CZ: hliník

SK: hliník

EN: aluminium

Uwagi / Komentář / Komentáre

PL: Zasilacz w komplecie

CZ: Napájení je součástí dodávky

SK: Napájanie je súčasťou dodávky

EN: Power supply included

BroLux

www.bowi.com.pl

REVOR



SŁUPKI BEZ ŹRÓDŁA ŚWIATŁA

CZ: Sloupky bez zdroje světla / SK: Stĺpiky bez zdroja svetla / EN: Posts without a light source



	INDEX	ABC		A [mm]	B [mm]	C [mm]	
A	013666	Revor	Czarny Černá	70	113	500	5902808804451
B	013667	Revor	Čierná Black	70	113	800	5902808804468



GU10



IN&OUT

IP

54



Materiał / Materiál / Material

PL: aluminium

CZ: hliník

SK: hliník

EN: aluminium

Uwagi / Komentář / Komentáre

PL: Zasilacz w komplecie

CZ: Napájení je součástí dodávky

SK: Napájanie je súčasťou dodávky

EN: Power supply included

BroLux

www.bowi.com.pl

SŁUPKI BEZ ŹRÓDŁA ŚWIATŁA

CZ: Sloupky bez zdroje světla / SK: Stĺpiky bez zdroja svetla / EN: Posts without a light source



INDEX			A [mm]	B [mm]	
006950	Ornis	Czarny Černá Čierná Black	90	500	5902808804642



GU10



IN&OUT

IP

44



Materiał / Materiál / Materiál

PL: aluminium

CZ: hliník

SK: hliník

EN: aluminium

Uwagi / Komentář / Komentáre

PL: Zasilacz w komplecie

CZ: Napájení je součástí dodávky

SK: Napájanie je súčasťou dodávky

EN: Power supply included

SŁUPKI BEZ ŹRÓDŁA ŚWIATŁA

CZ: Sloupky bez zdroje světla / SK: Stĺpiky bez zdroja svetla / EN: Posts without a light source



	INDEX	ABC		A [mm]	[mm]	
A	013653	Santa	Czarny Černá Čierna Black	90	495	5902808805076
B	013655	Santa		90	795	5902808805090
C	013654	Santa	Antracytowy RAL 7016 antracitová RAL 7016 anthracite RAL 7016	90	495	5902808805069
D	013656	Santa		90	795	5902808805083



GU10



IN&OUT



44



Materiał / Materiál / Material

PL: aluminium

CZ: hliník

SK: hliník

EN: aluminium

Uwagi / Komentář / Komentáre

PL: Zasilacz w komplecie

CZ: Napájení je součástí dodávky

SK: Napájanie je súčasťou dodávky

EN: Power supply included

SŁUPKI BEZ ŹRÓDŁA ŚWIATŁA

CZ: Sloupky bez zdroje světla / SK: Stĺpiky bez zdroja svetla / EN: Posts without a light source



	INDEX	ABC →			A [mm]	B [mm]	
A	003397	Soppa	Czarny Černá Čierná Black	PIR	80	450	5902808807643
B	003381	Soppa			80	450	5902808807636
C	003520	Soppa			80	650	5902808807650
D	003520	Soppa	Antracytowy RAL 7016 antracitová RAL 7016 antracitová RAL 7016 anthracite RAL 7016		80	450	5902808807629

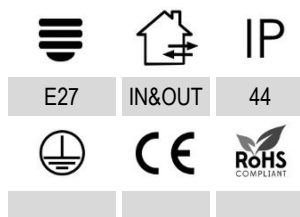

Materiał / Materiál / Material

PL: aluminium

CZ: hliník

SK: hliník

EN: aluminium

Uwagi / Komentář / Komentáre

PL: Zasilacz w komplecie

CZ: Napájení je součástí dodávky

SK: Napájanie je súčasťou dodávky

EN: Power supply included

OPRAWY SOLARNE

CZ: Solární svítidla/ SK: Slniečné svietidlá/ EN: Solar luminaires



INDEX						
6451	Amas LED	2,5 W	200 lm	3000 K	Czarny Černá Čierna Black	5902216789746

AC 230V	SMD LED	120°	NON-DIM
CRI/Ra		IP	
>80	50000 h	54	IN&OUT

Materiał / Materiál / Material

PL: aluminium

CZ: hliník

SK: hliník

EN: aluminium

Uwagi / Komentář / Komentáre

PL: Zasilacz w komplecie

CZ: Napájení je součástí dodávky

SK: Napájanie je súčasťou dodávky

EN: Power supply included

OPRAWY Z CZUJNIKIEM PIR



OPRAWY Z CZUJNIKIEM PIR

CZ: Světidla se snímačem PIR / SK: Svetidlá so snímačom PIR / EN: Lamps with PIR sensor



	INDEX	ABC		Lm			
A	003636	Laia LED	7 W	230 lm	3000 K	Czarny Černá Čierná Black	5902216721432
B	6506	Oshey LED	7 W	420 lm	3000 K		5902216721456
C	6515	Preston LED	9,5 W	680 lm	3000 K		5902216721463
D	007891	Riston LED	6,5 W	550 lm	3500 K		5902216721470

AC 230V	SMD LED	120°	NON-DIM
CRI/Ra	40000 h	IP	IN&OUT
>80	40000 h	54	IN&OUT

Materiał / Materiał / Material

PL: aluminium

CZ: hliník

SK: hliník

EN: aluminium

Uwagi / Komentář / Komentáre

PL: Zasilacz w komplecie

CZ: Napájení je součástí dodávky

SK: Napájanie je súčasťou dodávky

EN: Power supply included

Brolux

www.bowi.com.pl

OPRAWY WEWNĘTRZNE LED

CZ: Vnitřní LED lampy / SK: Vnútorné LED lampy / EN: Indoor LED Lamps



A	007855	ALARD	6 W	420 lm	4500 K	Biały biła white	44	5902216738812
B	010492	BRONTE	6 W	420 lm	4500 K		44	5902216767973
C	007850	CLARY	12 W	1440 lm	4500 K		44	5902216738782
D	007853	HOLTI	6 W	720 lm	4500 K		44	5902216738768
E	007854	JALIN	3 W	360 lm	4500 K		44	5902216738775
F	007856	MELION	3 W	300 lm	4500 K		44	5902216738805
G	010497	MINIA	5 W	350 lm	4500 K		44	5902216789050
H	010767	OFA	7 W	490 lm	4500 K		44	5902216767966
I	010761	SAER	7 W	490 lm	4500 K		44	5902216767959
J	010764	SAGAR	7 W	490 lm	4500 K		44	5902216767942
K	010765	SAGAR	8 W	560 lm	4500 K		44	5902216767935
L	010760	YALE	8 W	560 lm	4500 K		44	5902216793002

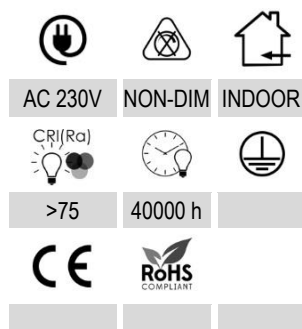

Materiał / Materiál / Materiál

PL: aluminium

CZ: hliník

SK: hliník

EN: aluminum

Uwagi / Komentář / Komentáre

PL: Zasilacz w komplecie

CZ: Napájení je součástí dodávky

SK: Napájanie je súčasťou dodávky

EN: Power supply included

OPRAWY WEWNĘTRZNE LED

CZ: Vnitřní LED lampy / SK: Vnútorné LED lampy / EN: Indoor LED Lamps



A



B



C



D



E



F

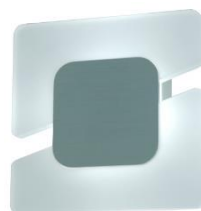

G



H



I



J



K



L

KINIA



SPOTLIGHTY

CZ: Reflektory / SK: Spotlights EN: Spotlight



A



B



C



D



E



F



INDEX



A
[mm]

B
[mm]

C
[mm]



	INDEX	ABC		A [mm]	B [mm]	C [mm]	
A	013101	Kinia	Czarny Černá Čierny Black	110	70	126	5902216721425
B	013102	Kinia	Biały biła Bielá white	110	70	126	5902216725614
C	013103	Kinia	Czarny Černá Čierny Black	220	70	120	5902216741065
D	013104	Kinia	Biały biła Bielá white	220	70	120	5902216742949
E	013105	Kinia	Czarny Černá Čierny Black	350	70	120	5902216758629
F	013106	Kinia	Biały biła Bielá white	350	70	120	5902216763685

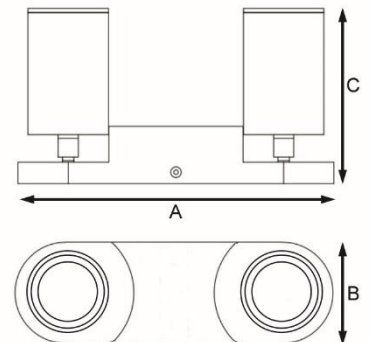

GU10

IP

20



RoHS
COMPLIANT

Materiał / Materiál / Material

PL: aluminium

CZ:hliník

SK: hliník

EN:aluminum

Brólux

www.bowi.com.pl

FARGO



SPOTLIGHTY

CZ: Reflektory / SK: Spotlights EN: Spotlight



		INDEX			A [mm]	B [mm]	C [mm]	
A		009499	Fargo	Biały biła Bielá white	60	60	25	5902216701502
B		013357	Fargo	Czarny Černá Čierny Black	60	60	25	5902808801320
C		013358	Fargo	Czarny Černá Čierny Black	260	60	25	5902808801344
D		013359	Fargo	Biały biła Bielá white	260	60	25	5902808801337
E		013361	Fargo	Biały biła Bielá white	380	60	25	5902808801368
F		013360	Fargo	Czarny Černá Čierny Black	380	60	25	5902808801351
G		013539	Fargo	Biały biła Bielá white	180	180	147	5902808803553
H		013540	Fargo	Czarny Černá Čierny Black	180	180	147	5902808803560
I		013362	Fargo	Czarny Černá Čierny Black	260	260	25	5902808801382
J		013363	Fargo	Biały biła Bielá white	260	260	25	5902808801375

Materiał / Materiál / Material

PL: aluminium

CZ:hliník

SK: hliník

EN:aluminum



IP



GU10

20

Brólux

www.bowi.com.pl

SARGO







SPOTLIGHTY

CZ: Reflektory / SK: Spotlights EN: Spotlight



A

B

		INDEX			A [mm]	B [mm]	
A		014000	Sargo	Czarny Černá Čierny Black	56	145	5902808808374
F		014001	Sargo	Biały bílá Bielá white	56	145	5902808808381



GU10

IP

20



Materiał / Materiál / Material

PL: aluminium

CZ:hliník

SK: hliník

EN:aluminum

BroLux

www.bowi.com.pl

KYNIS



SPOTLIGHTY

CZ: Reflektory / SK: Spotlights EN: Spotlight



INDEX



A [mm]

B [mm]



C [mm]

D [mm]

E [mm]



	INDEX	ABC		A [mm]	B [mm]	C [mm]	D [mm]	E [mm]	
A	011202	Kynis	Biały Bílá Bielá White	80	68	80	25		5902808806127
B	011204	Kynis		80	68	80	25	220-315	5902216795372
C	011545	Kynis		80	68	90	25	385	5902808806158
D	011203	Kynis	Czarny Černá Čierny Black	80	68	80	25		5902216734036
E	010249	Kynis		80	68	80	25	220-315	5902808806141
F	011544	Kynis		80	68	90	25	385	5902808806165



GU10

IP

20



RoHS COMPLIANT

Materiał / Materiál / Material

PL: metal

CZ: kov

SK: kov

EN: metal

BroLux

www.bowi.com.pl





DEZ



SPOTLIGHTY

CZ: Reflektory / SK: Spotlights EN: Spotlight



		INDEX			A [mm]	B [mm]	C [mm]	D [mm]	E [mm]	
A		003371	Dez	Biały Bílá Bielá White	60	90	78	25		5902808806127
B		009043	Dez		60	90	80	25	275	5902216795372
C		011006	Dez		60	90	81	25	475	5902808806158
D		008071	Dez	Czarny Černá Čierny Black	60	90	78	25		5902216734036
E		009046	Dez		60	90	80	25	275	5902808806141
F		009044	Dez		60	90	81	25	475	5902808806165



GU10

IP

20



Materiał / Materiál / Material

PL: metal

CZ: kov

SK: kov

EN: metal

BroLux

www.bowi.com.pl

BAROCO



OPRAWY NATYNKOWE BEZ ŹRÓDŁA ŚWIATŁA

CZ: Nadomítkové svítidla bez zdroje světla / SK: Nadomietkové svietidlá bez zdroja svetla / EN: Surface-mounted luminaires without light source



A



B

	INDEX	ABC		A [mm]	B [mm]	C [mm]	
A	012864	Baroco	Czarny Černá Čierná Black	180	180	125	5902216798304
B	012863	Baroco	Biały biła biła white	180	180	125	5902216798311



AC 230V



GU10

IP

20



IN



Materiał / Material / Material

PL: aluminium

CZ: hliník

SK: hliník

EN: aluminium

Brolux

www.bowi.com.pl





CREEP



OPRAWY NATYNKOWE BEZ ŹRÓDŁA ŚWIATŁA

CZ: Nadomítkové svítidla bez zdroje světla / SK: Nadomietkové svietidlá bez zdroja svetla / EN: Surface-mounted luminaires without light source

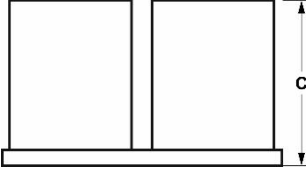
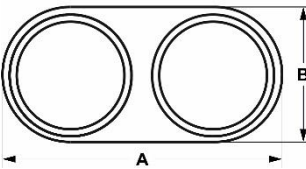

		INDEX			A [mm]	B [mm]	C [mm]		
A		013293	Creep	Czarny Černá Čierny Black	80	80	100	5902808800699	
B		013295	Creep		260	100	120	5902808800705	
C		013292	Creep	Biały bílá Bielá white	80	80	100	5902808800712	
F		013294	Creep		260	100	120	5902808800729	

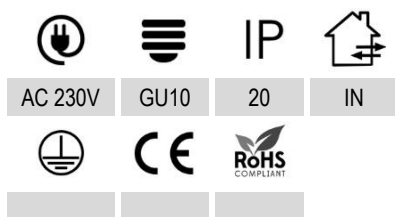

Materiał / Materiál / Material

PL: aluminium

CZ:hliník

SK: hliník

EN:aluminum

Brolux

www.bowi.com.pl

OPRAWY NATYNKOWE BEZ ŹRÓDŁA ŚWIATŁA

CZ: Nadomítkové svítidla bez zdroje světla / SK: Nadomietkové svietidlá bez zdroja svetla / EN: Surface-mounted luminaires without light source

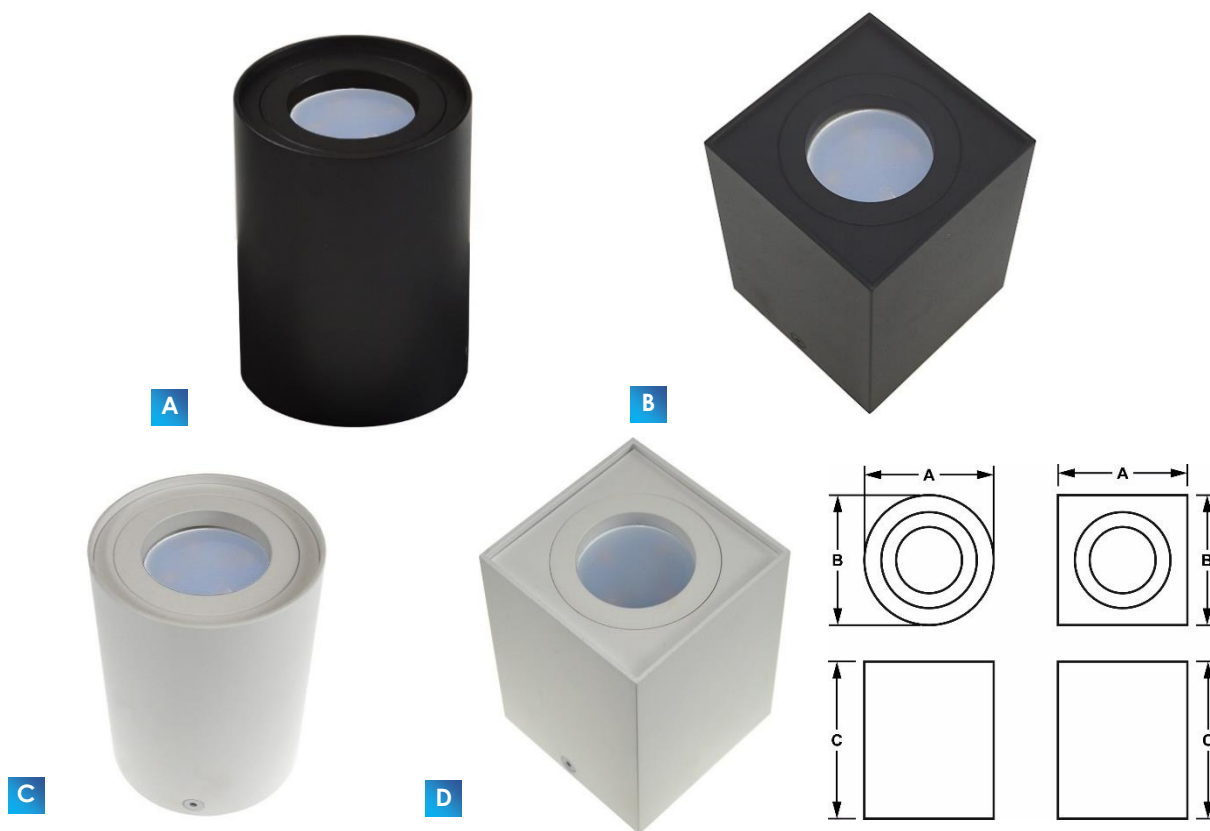

	INDEX	ABC		A [mm]	B [mm]	C [mm]	
A	012479	Criko	Czarny Černá Čierná Black	80	80	110	5902216795662
B	012482	Criko	Czarny Černá Čierná Black	80	80	110	5902216795679
C	012480	Criko	Biały bílá biła white	80	80	110	5902216795686
D	012481	Criko	Biały bílá biła white	80	80	110	5902216795693

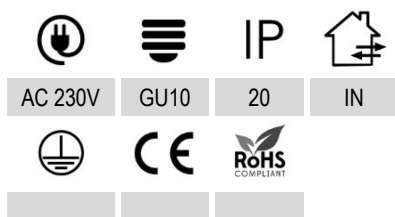

Materiał / Material / Material
 PL: aluminium
 CZ: hliník
 SK: hliník
 EN: aluminium

OPRAWY NATYNKOWE BEZ ŹRÓDŁA ŚWIATŁA

CZ: Nadomítkové svítidla bez zdroje světla / SK: Nadomietkové svietidlá bez zdroja svetla / EN: Surface-mounted luminaires without light source



INDEX



A [mm]

B [mm]



	INDEX	Color	Material	A [mm]	B [mm]	Barcode
A	012671	Cyrol	Czarny Černá Čierná Black	80	100	5902216797413
B	012674	Cyrol	Czarny Černá Čierná Black	80	100	5902808807889
C	012672	Cyrol	Biały biłá biłá white	80	100	5902216797420
D	012673	Cyrol	Biały biłá biłá white	80	100	5902808807896



AC 230V



GU10



20



IN



Materiał / Material / Material

PL: aluminium

CZ: hliník

SK: hliník

EN: aluminium

OPRAWY NATYNKOWE BEZ ŹRÓDŁA ŚWIATŁA

CZ: Nadomítkové svítidla bez zdroje světla / SK: Nadomietkové svietidlá bez zdroja svetla / EN: Surface-mounted luminaires without light source

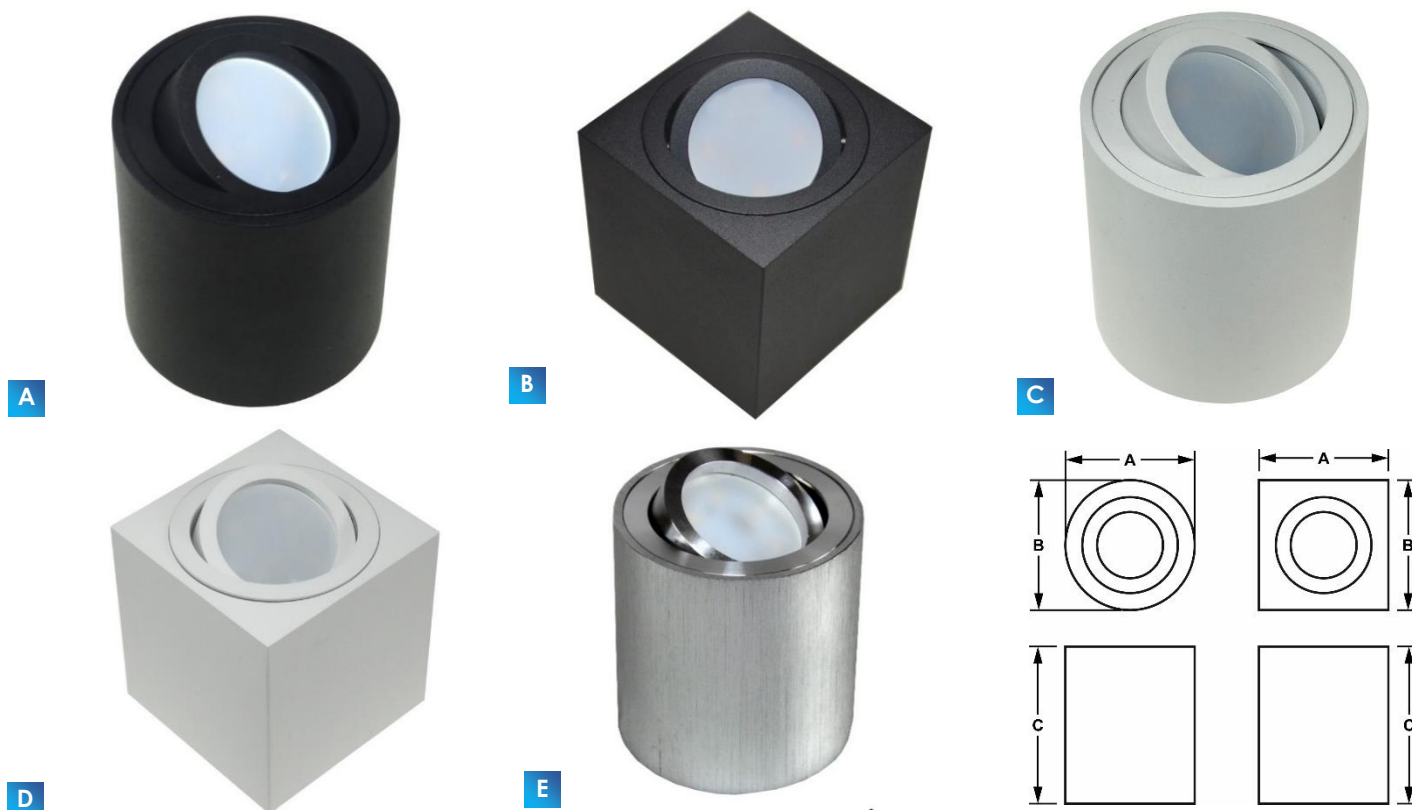

	INDEX	ABC		A [mm]	B [mm]	C [mm]	
A	012822	Febe	Czarny Černá Čierná Black	80	80	84	5902216795662
B	012824	Febe	Biały bílá bilá white	80	80	84	5902216795679
C	012823	Febe	Srebrny Stieborná stříbrná silver	80	80	84	5902216795693
D	012825	Febe		80	80	84	5902216799349
E	012968	Febe		80	80	84	

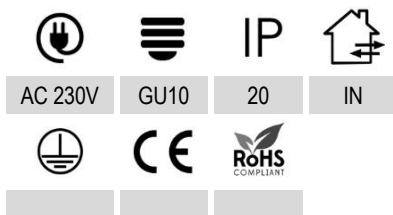

Materiał / Materiál / Material
 PL: aluminium
 CZ: hliník
 SK: hliník
 EN: aluminium

OPRAWY NATYNKOWE BEZ ŹRÓDŁA ŚWIATŁA

CZ: Nadomítkové svítidla bez zdroje světla / SK: Nadomietkové svietidlá bez zdroja svetla / EN: Surface-mounted luminaires without light source



	INDEX	ABC		A [mm]	B [mm]	C [mm]	
A	012425	SIROCO	Czarny Černá Čierny Black	96	96	125	5902216789029
B	012426	SIROCO		175	97	125	5902216767973
C	012667	SIROCO		97	97	125	5902216797437
D	012669	SIROCO		185	96	125	5902216797444
E	013060	SIROCO	Czarno - Srebrny Černostieborná Čiernostříbrná Black and silver	96	96	125	5902216799707
F	012427	SIROCO	Biały biła bielá white	96	96	125	5902216789036
G	012428	SIROCO		175	97	125	5902216789043
H	012668	SIROCO		97	97	125	5902216797451
I	012670	SIROCO		185	96	125	5902216797468
J	012972	SIROCO	Srebrny Stieborná stříbrná silver	96	96	125	5902216799509

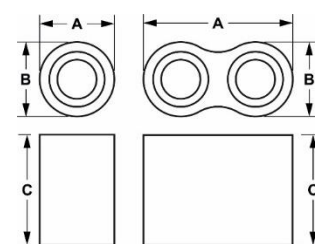

GU10

Materiał / Materiál / Material

PL: aluminium

CZ:hliník

SK: hliník

EN:aluminum

Brölux

OPRAWY NATYNKOWE BEZ ŹRÓDŁA ŚWIATŁA

CZ: Nadomítkové svítidla bez zdroje světla / SK: Nadomietkové svietidlá bez zdroja svetla / EN: Surface-mounted luminaires without light source



	INDEX			A [mm]	B [mm]	C [mm]	
A	012975	SIROK	Czarny Černá Čierna Black	90	90	100	5902216799394
B	012980	SIROK		180	90	100	5902216799400
C	012978	SIROK		90	90	100	5902216799417
D	012974	SIROK	Biały biła bielá white	90	90	100	5902216799424
E	012979	SIROK		180	90	100	5902216799431
F	012977	SIROK		90	90	100	5902216799448



GU10

Materiał / Materiál / Material

PL: aluminium

CZ:hliník

SK: hliník

EN:aluminum

FARA IP54



OPRAWY NATYNKOWE BEZ ŹRÓDŁA ŚWIATŁA

CZ: Nadomítkové svítidla bez zdroje světla / SK: Nadomietkové svietidlá bez zdroja svetla / EN: Surface-mounted luminaires without light source

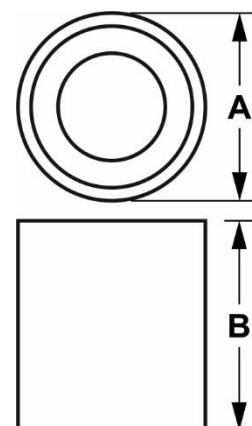

A

B

	INDEX			A [mm]	[mm]	
A	013039	FARA	Biały Bílá Bielá White	80	84	5902216799554
B	013040	FARA	Czarny Černá Čierná Black	80	84	5902216799561



GU10

IP

54



Materiał / Materiál / Material

PL: aluminium

CZ:hliník

SK: hliník

EN:aluminum

Brolux

OPRAWY NATYNKOWE BEZ ŹRÓDŁA ŚWIATŁA

CZ: Nadomítkové svítidla bez zdroje světla / SK: Nadomietkové svietidlá bez zdroja svetla / EN: Surface-mounted luminaires without light source



A



B

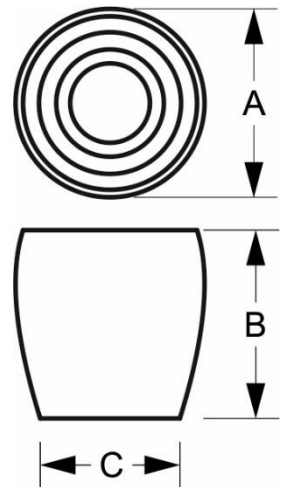

	INDEX			A [mm]	B [mm]	C [mm]	
A	013091	BESA	Czarny Černá Čierná Black	96	100	77	5902216799905
B	013092	BESA	Biały biła bielá white	96	100	77	5902216799899



GU10

IP

CE



Materiał / Materiál / Material

PL: aluminium

CZ:hliník

SK: hliník

EN:aluminum

Br**o**lux

KARADON



OPRAWY NATYNKOWE BEZ ŹRÓDŁA ŚWIATŁA

CZ: Nadomítkové svítidla bez zdroje světla / SK: Nadomietkové svietidlá bez zdroja svetla / EN: Surface-mounted luminaires without light source



A

B

C

D



INDEX



A [mm]



B [mm]



	INDEX	ABC		A [mm]	B [mm]	Barcode
A	013095	Karadon	Biały biła white	56	170	5902808800767
B	013099	Karadon		56	290	5902808800774
C	013094	Karadon	Czarny Černá Čierny Black	56	170	5902808800781
D	013098	Karadon		56	290	5902808800798



GU10

IP

CE



Materiał / Materiál / Material

PL: aluminium

CZ:hliník

SK: hliník

EN:aluminum

BroLux

PIREUS



OPRAWY NATYNKOWE BEZ ŹRÓDŁA ŚWIATŁA

CZ: Nadomítkové svítidla bez zdroje světla / SK: Nadomietkové svietidlá bez zdroja svetla / EN: Surface-mounted luminaires without light source



A



B



	INDEX			A [mm]	B [mm]	
A	013366	PIREUS	Biały biła white	80	84	5902808801405
B	009491	PIREUS	Czarny Černá Čierny Black	80	84	5902216701540



GU10

IP

CE



Materiał / Materiál / Material

PL: aluminium

CZ:hliník

SK: hliník

EN:aluminum

BroLux

www.bowi.com.pl

OPRAWY NATYNKOWE BEZ ŹRÓDŁA ŚWIATŁA

CZ: Nadomítkové svítidla bez zdroje světla / SK: Nadomietkové svietidlá bez zdroja svetla / EN: Surface-mounted luminaires without light source



	INDEX			A [mm]	B [mm]	
A	013004	CIMKO	Biały biła white	85	115	5902808801474
B	013005	CIMKO	Czarny Černá Čierny Black	85	115	5902808801481



GU10

IP

CE



Materiał / Materiál / Material

PL: aluminium

CZ:hliník

SK: hliník

EN:aluminum

Br^olux





ARENO



OPRAWY NATYNKOWE BEZ ŹRÓDŁA ŚWIATŁA

CZ: Nadomítkové svítidla bez zdroje světla / SK: Nadomietkové sietidlá bez zdroja svetla / EN: Surface-mounted luminaires without light source



	INDEX			A [mm]	B [mm]	C [mm]	
A	013354	ARENO	Czarny Černá Čierny Black	87	100	115	5902808801443
B	013805	ARENO		87	100	84	5902808806493
C	013355	ARENO	Biały biła bielá white	87	100	115	5902808801450
D	013804	ARENO		87	100	84	5902808806509



GU10

IP

CE



Materiał / Materiál / Material

PL: aluminium

CZ:hliník

SK: hliník

EN:aluminum

Brolux

www.bowi.com.pl

OPRAWY NATYNKOWE BEZ ŹRÓDŁA ŚWIATŁA

CZ: Nadomítkové svítidla bez zdroje světla / SK: Nadomietkové svietidlá bez zdroja svetla / EN: Surface-mounted luminaires without light source



	INDEX			A [mm]	B [mm]	
A	013376	Valda	Biały biała Bielá white	55	160	5902808801498
B	013375	Valda	Czarny Černá Čierny Black	55	160	5902808801504
C	013378	Valda	Biały biała Bielá white	55	220	5902808801511
D	013377	Valda	Czarny Černá Čierny Black	55	220	5902808801528
E	013380	Valda	Biały biała Bielá white	55	300	5902808801535
F	013379	Valda	Czarny Černá Čierny Black	55	300	5902808801542



GU10

IP

20



Materiał / Materiál / Material

PL: aluminium

CZ:hliník

SK: hliník

EN:aluminium

Brolux





VALDA WISZĄCE



OPRAWY NATYNKOWE BEZ ŹRÓDŁA ŚWIATŁA

CZ: Nadomítkové svítidla bez zdroje světla / SK: Nadomietkové svietidlá bez zdroja svetla / EN: Surface-mounted luminaires without light source



	INDEX			A [mm]	B [mm]	
A	006959	Valda	Czarny Černá Čierny Black	55	160	5902216709225
B	006960	Valda		55	220	5902216709232
C	006957	Valda		55	300	5902216709232



IP



GU10

20

Materiał / Materiál / Material

PL: aluminium

CZ:hliník

SK: hliník

EN:aluminum

Brlux

CANDY



OPRAWY NATYNKOWE BEZ ŹRÓDŁA ŚWIATŁA

CZ: Nadomítkové svítidla bez zdroje světla / SK: Nadomietkové svietidlá bez zdroja svetla / EN: Surface-mounted luminaires without light source



A



B

	INDEX			A [mm]	B [mm]	
A	013356	Candy	Biały biła white	60	100	5902808801313
B	009500	Candy	Czarny Černá Čierny Black	60	100	5902216711716



GU10

IP

20



Materiał / Materiál / Material

PL: aluminium

CZ:hliník

SK: hliník

EN:aluminum

Brolux

OPRAWY NATYNKOWE BEZ ŹRÓDŁA ŚWIATŁA

CZ: Nadomítkové svítidla bez zdroje světla / SK: Nadomietkové svietidlá bez zdroja svetla / EN: Surface-mounted luminaires without light source



A



B

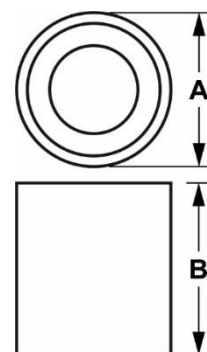

	INDEX			A [mm]	B [mm]	
A	013289	Corona	Biały biła biela white	80	110	5902808800620
B	013288	Corona	Czarny Černá Čierny Black	80	110	5902808800613



GU10

IP

20



Materiał / Materiál / Material

PL: aluminium

CZ:hliník

SK: hliník

EN:aluminum

BroLux

OPRAWY NATYNKOWE BEZ ŹRÓDŁA ŚWIATŁA

CZ: Nadomítkové svítidla bez zdroje světla / SK: Nadomietkové svietidlá bez zdroja svetla / EN: Surface-mounted luminaires without light source



	INDEX			A [mm]	 D [mm]	C [mm]	
A	013681	Pita	Biały biła white	140	140	86	5902808804611
B	013682	Pita	Czarny Černá	250	140	86	5902808804604
C	1680	Pita	Čierny Black	140	140	86	5902808807230



GU10

IP

20



Materiał / Materiál / Material

PL: aluminium

CZ:hliník

SK: hliník

EN:aluminum

Brolux

OPRAWY NATYNKOWE BEZ ŹRÓDŁA ŚWIATŁA

CZ: Nadomítkové svítidla bez zdroje světla / SK: Nadomietkové svietidlá bez zdroja svetla / EN: Surface-mounted luminaires without light source



A



B



C



D



E



F

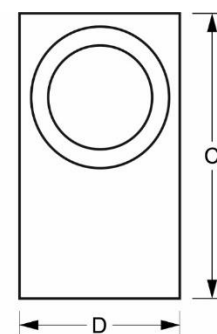
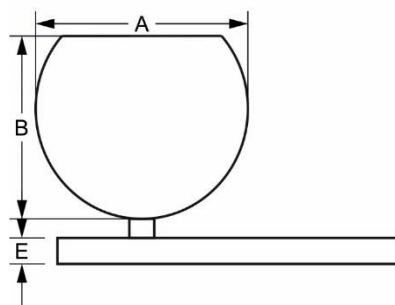

	INDEX			A [mm]	B [mm]	C [mm]	D [mm]	E [mm]	
A	013771	Colm	Biały biła biela white	90	75	103	92	25	5902808805960
B	013775	Colm		90	75	160	90	25	5902808805977
C	013773	Colm		90	75	307	91	25	5902808805779
D	013770	Colm	Czarny Černá Čierny Black	90	75	103	92	25	5902808805991
E	013774	Colm		90	75	160	90	25	5902808806004
F	013772	Colm		90	75	307	91	25	5902808805786



GU10

IP

20

CE



Materiał / Materiał / Material

PL: aluminium

CZ:hliník

SK: hliník

EN:aluminum

Brólux

COLM WISZĄCY



OPRAWY NATYNKOWE BEZ ŹRÓDŁA ŚWIATŁA

CZ: Nadomítkové svítidla bez zdroje světla / SK: Nadomietkové svietidlá bez zdroja svetla / EN: Surface-mounted luminaires without light source



				A [mm]	B [mm]	C [mm]	D [mm]	E [mm]	F [mm]	
	INDEX									
A	013776	Colm	Biały biela white	90	75	1200	100		25	5902808805984
B	013778	Colm		90	75	1200	430	55	27	5902808805793
C	013777	Colm	Czarny Černá Čierny Black	90	75	1200	100		25	5902808806011
D	013779	Colm		90	75	1200	430	55	27	5902808806028



GU10

IP

20



Materiał / Materiál / Material

PL: aluminium

CZ:hliník

SK: hliník

EN:aluminum

BroLux

www.bowi.com.pl

SPLIT



OPRAWY NATYNKOWE BEZ ŹRÓDŁA ŚWIATŁA

CZ: Nadomítkové svítidla bez zdroje světla / SK: Nadomietkové svietidlá bez zdroja svetla / EN: Surface-mounted luminaires without light source



	INDEX	ABC		A [mm]	B [mm]	C [mm]	D [mm]	E [mm]	
A	012881	Split	Biały biela bielá white	80	340	100	25	1050	5902808806035
B	012880	Split	Czarny Černá Čierny Black	80	340	100	25	1050	5902216726611



GU10

IP

20



Materiał / Materiál / Materiál

PL: aluminium

CZ:hliník

SK: hliník

EN:aluminum

Br**o**lux

www.bowi.com.pl

OPRAWY NATYNKOWE BEZ ŹRÓDŁA ŚWIATŁA

CZ: Nadomítkové svítidla bez zdroje světla / SK: Nadomietkové svietidlá bez zdroja svetla / EN: Surface-mounted luminaires without light source



A



B

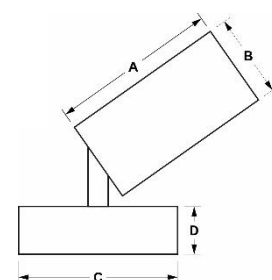

		INDEX			A [mm]	B [mm]	C [mm]	D [mm]	
A		010252	Stif	Biały biela white	80	95	57	38	5902808805816
B		009041	Stif	Czarny Černá Čierny Black	80	95	57	38	5902216726611



GU10

IP

20



Materiał / Material / Material

PL: aluminium

CZ:hliník

SK: hliník

EN:aluminum

Br^olux

OPRAWY NATYNKOWE BEZ ŹRÓDŁA ŚWIATŁA

CZ: Nadomítkové svítidla bez zdroje světla / SK: Nadomietkové svietidlá bez zdroja svetla / EN: Surface-mounted luminaires without light source

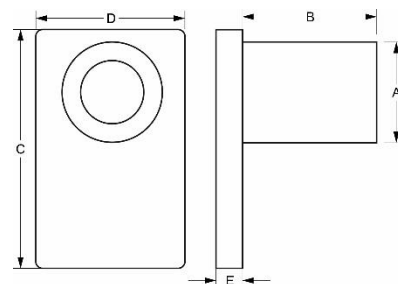

A

B

		INDEX			A [mm]	B [mm]	C [mm]	D [mm]	E [mm]	
A		011176	Taft	Biały biła bielá white	67	89	160	100	30	5902216782853
B		011177	Taft	Czarny Černá Čierny Black	67	89	160	100	30	5902216726475



GU10

IP

20



Materiał / Materiál / Material

PL: aluminium

CZ:hliník

SK: hliník

EN:aluminum

BroLux

OPRAWY NATYNKOWE BEZ ŹRÓDŁA ŚWIATŁA

CZ: Nadomítkové svítidla bez zdroje světla / SK: Nadomietkové svietidlá bez zdroja svetla / EN: Surface-mounted luminaires without light source

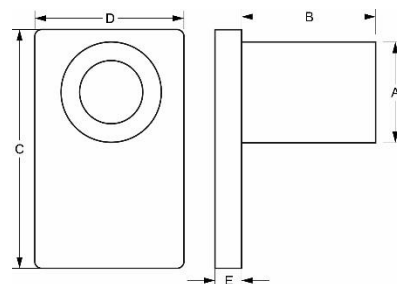

A

B

		INDEX			A [mm]	B [mm]	C [mm]	D [mm]	E [mm]	
A		010053	Terok	Biały biła bielá white	75	92	170	98	33	5902216782853
B		010052	Terok	Czarny Černá Čierny Black	75	92	170	98	33	5902808805809



GU10

IP

20



Materiał / Materiál / Material

PL: aluminium

CZ:hliník

SK: hliník

EN:aluminum

BroLux

TRELO



OPRAWY NATYNKOWE BEZ ŹRÓDŁA ŚWIATŁA

CZ: Nadomítkové svítidla bez zdroje světla / SK: Nadomietkové sietidlá bez zdroja svetla / EN: Surface-mounted luminaires without light source



A

B

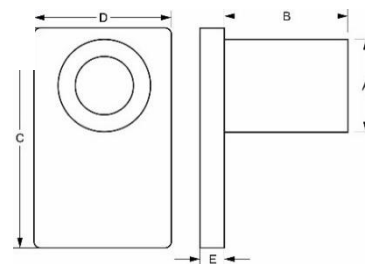

		INDEX			A [mm]	B [mm]	C [mm]	D [mm]	E [mm]	
A		009045	Trelo	Biały biła bielá white	80	86	160	90	20	5902216782853
B		009042	Trelo	Czarny Černá Čierny Black	80	86	160	90	20	5902808805809



GU10

IP

20



Materiał / Materiál / Material

PL: aluminium

CZ:hliník

SK: hliník

EN:aluminum

BroLux

OPRAWY NATYNKOWE BEZ ŹRÓDŁA ŚWIATŁA

CZ: Nadomítkové svítidla bez zdroje světla / SK: Nadomietkové svietidlá bez zdroja svetla / EN: Surface-mounted luminaires without light source



A



B

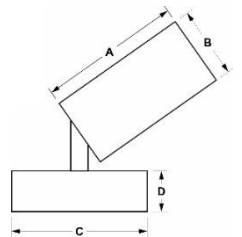

	INDEX			A [mm]	B [mm]	C [mm]	D [mm]	
A	009040	Troy	Biały biela white	75	86	100	30	5902216726635
B	009042	Troy	Czarny Černá Čierny Black	75	86	100	30	5902808805809



GU10

IP

20



Materiał / Materiál / Material

PL: aluminium

CZ:hliník

SK: hliník

EN:aluminum

BroLux

RACHID



OPRAWY NATYNKOWE BEZ ŹRÓDŁA ŚWIATŁA

CZ: Nadomítkové svítidla bez zdroje světla / SK: Nadomietkové svietidlá bez zdroja svetla / EN: Surface-mounted luminaires without light source



A



B

INDEX	ABC		A [mm]	B [mm]	
005241	Rachid	Biały bílá bielá white	60	150	5902216786271
011201	Rachid	Czarny Černá Čierny Black	60	150	5902808806073



GU10

IP

20



Materiał / Materiał / Material

PL: aluminium

CZ:hliník

SK: hliník

EN:aluminum

Brølux

www.bowi.com.pl

OPRAWY NATYNKOWE BEZ ŹRÓDŁA ŚWIATŁA

CZ: Nadomítkové svítidla bez zdroje světla / SK: Nadomietkové svietidlá bez zdroja svetla / EN: Surface-mounted luminaires without light source



A



B

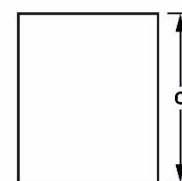
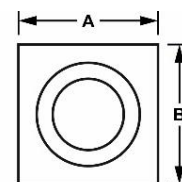

	INDEX			A [mm]	B [mm]	
A	009960	Sara	Biały biela white	80	95	5902808802624
B	7065	Sara	Czarny Černá Čierny Black	80	95	5902216748040



GU10

IP

54



Materiał / Materiál / Materiál

PL: aluminium

CZ:hliník

SK: hliník

EN:aluminum

OPRAWY NATYNKOWE BEZ ŹRÓDŁA ŚWIATŁA

CZ: Nadomítkové svítidla bez zdroje světla / SK: Nadomietkové svietidlá bez zdroja svetla / EN: Surface-mounted luminaires without light source



INDEX	ABC		A [mm]	B [mm]	
009498	Akona	Czarny Černá Čierná Black	80	85	5902216701472



GU10

IP

20



Materiał / Materiál / Materiál

PL: aluminium

CZ:hliník

SK: hliník

EN:aluminum

Brolux

OPRAWY NATYNKOWE BEZ ŹRÓDŁA ŚWIATŁA

CZ: Nadomítkové svítidla bez zdroje světla / SK: Nadomietkové svietidlá bez zdroja svetla / EN: Surface-mounted luminaires without light source

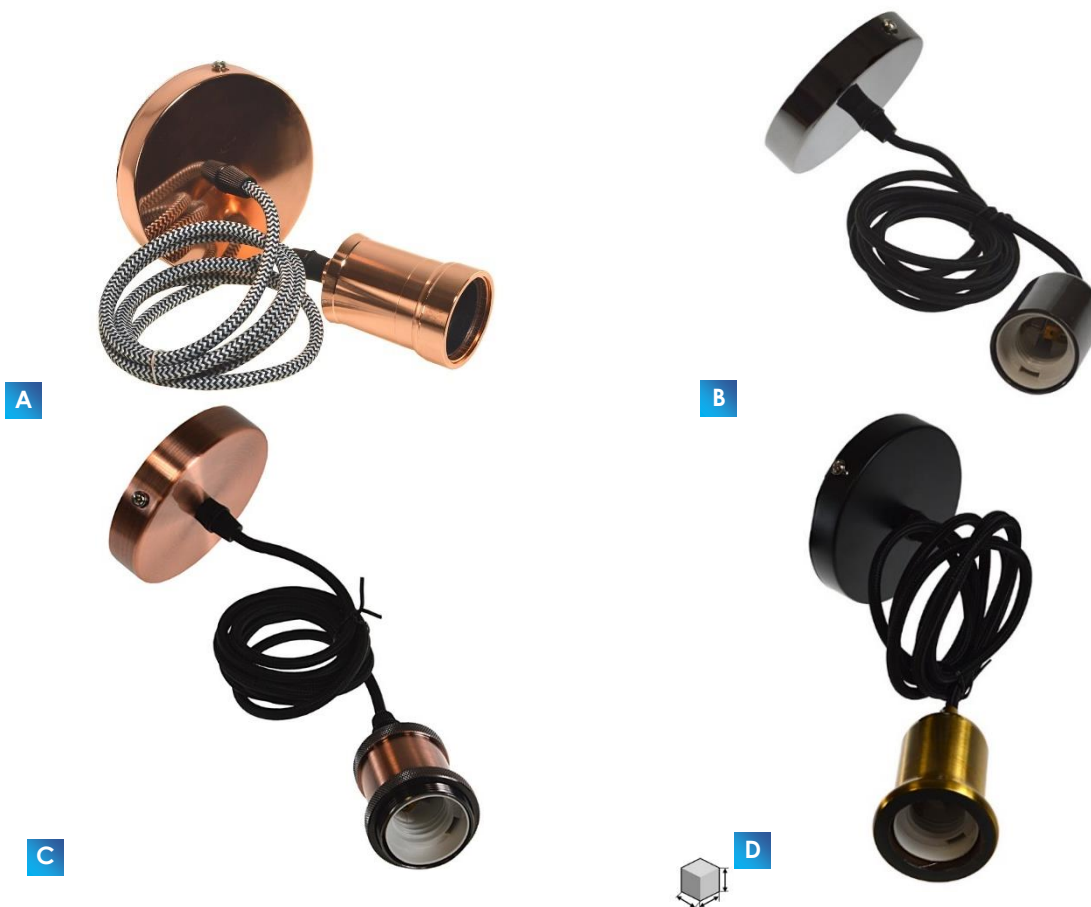

	INDEX		A [mm]	B [mm]	
A	012582	Mosiężny Mosazná Mosadzná Brass	48	73	5902216797673
B	012583	Czarny Černá Čierny Black	42	63	5902216797680
C	013094	Mosiężny Mosazná Mosadzná Brass	50	58	5902216797697
D	013098	Złoty Zlatá Zlatá Gold	54	92	5902808800798



IP



GU10

Materiał / Materiál / Materiál

PL: aluminium

CZ:hliník

SK: hliník

EN:aluminum

OPRAWY NATYNKOWE BEZ ŹRÓDŁA ŚWIATŁA

CZ: Nadomítkové svítidla bez zdroje světla / SK: Nadomietkové svietidlá bez zdroja svetla / EN: Surface-mounted luminaires without light source



	INDEX		A [mm]	B [mm]	
A	045446	Brązowy Hnědá Hnedá Brown	40	90	5902808808695
B	045444	Czarny Černá Čierná Black	40	90	5902808808701
C	045442	Czerwony Červená Červená Red	40	90	5902808808718
D	045448	Fioletowy fialová Fialová Purple	40	90	5902808808725
E	045451	Niebieski Modrá Modrá Blue	40	90	5902808808787
F	045445	Pomarańczowy Pomerančová Oranžová Orange	40	90	5902808808732
G	045447	Szary Šedá Šedá Grey	40	90	5902808808749
H	045443	Zielony Zelená Zelená Green	40	90	5902808808756



IP



GU10

Materiál / Material / Material

PL: Tworzywo sztuczne

CZ: Plast

SK: Plast

EN: Plastic

OPRAWY NATYNKOWE BEZ ŹRÓDŁA ŚWIATŁA

CZ: Nadomítkové svítidla bez zdroje světla / SK: Nadomietkové svietidlá bez zdroja svetla / EN: Surface-mounted luminaires without light source



A



B

	INDEX		A [mm]	B [mm]	
A	045449	Zielony Zelená Zelená Green	40	90	5902808808763
B	045450	Żółty Żlutá Żłtá Yellow	40	90	5902808808770



GU10

IP

CE



Materiał / Materiál / Material

PL: Tworzywo sztuczne

CZ: Plast

SK: Plast

EN:Plastic

Brulux

KARBO



TRACK LIGHT GU10

CZ: Lištové svítidlo GU10 / SK: Lištové svietidlo GU10 / EN: track light GU10



A



B

	INDEX			A [mm]	B [mm]	
A	013783	Karbo	Biały biła bielá white	60	140	5902808806080
B	013784	Karbo	Czarny Černá Čierny Black	60	140	5902808806097



GU10

IP

20



Materiał / Materiál / Materiál

PL: aluminium

CZ:hliník

SK: hliník

EN:aluminum

Br^olux

www.bowi.com.pl

TRACK LIGHT GU10

CZ: Lištové svítidlo GU10 / SK: Lištové svietidlo GU10 / EN: track light GU10



A



B

	INDEX			A [mm]	B [mm]	
A	009495	NILSO	Czarny Černá Čierny Black	80	84	5902216736269
B	013365	NILSO	Biały bílá bielá white	80	84	5902808801412



GU10

IP

20



Materiał / Materiál / Material

PL: aluminium

CZ: hliník

SK: hliník

EN: aluminum

Brolux

KARADON



TRACK LIGHT GU10

CZ: Lištové svítidlo GU10 / SK: Lištové svetidlo GU10 / EN: track light GU10



	INDEX	ABC		A [mm]	B [mm]	
A	013094	Karadon	Czarny Černá Čierny Black	56	170	5902808800781
B	045422	Karadon		56	500	5902808809029



GU10

IP



Materiał / Material / Material

PL: aluminium

CZ:hliník

SK: hliník

EN:aluminum

Brolux

www.bowi.com.pl

OPRAWY PODTYNKOWE BEZ ŹRÓDŁA ŚWIATŁA

CZ: Podomítkové svítidla bez zdroje světla / SK: Podomietkové svietidlá bez zdroja svetla / EN
Concealed luminaires without light source



A



B



C



D

	INDEX	ABC		A [mm]	B [mm]	
A	012984	KOBRA	Czarny Černá Čierná Black	102	54	5902216799356
B	012983	KOBRA		101	55	5902216795679
C	012982	KOBRA	Biały biła bielá white	102	54	5902216795686
D	012981	KOBRA		101	55	5902216795693



GU10



RoHS
COMPLIANT

Materiał / Materiál / Material

PL: aluminium

CZ:hliník

SK: hliník

EN:aluminum

OPRAWY PODTYNKOWE BEZ ŹRÓDŁA ŚWIATŁA

CZ: Podomítkové svítidla bez zdroje světla / SK: Podomietkové svietidlá bez zdroja svetla / EN
Concealed luminaires without light source



A



B



C



D



	INDEX			A [mm]	B [mm]	C [mm]	
A	013088	Coriko	Biały biła bielá white	92	92	35	5902808801221
B	012994	Coriko	Czarno- biaty Černobilá Černobilá Black -white	92	92	35	5902808801238
C	013087	Coriko	Czarno-biaty Černobilá Černobilá Black -white	92	92	35	5902808801245
D	012998	Coriko	Czarny Černá Čierny Black	92	92	35	5902808801252



GU10

IP

CE



Materiał / Materiál / Material

PL: aluminium

CZ:hliník

SK: hliník

EN:aluminium

DELIUS



OPRAWY PODTYNKOWE BEZ ŹRÓDŁA ŚWIATŁA

CZ: Podomítkové svítidla bez zdroje světla / SK: Podomietkové svietidlá bez zdroja svetla / EN
Concealed luminaires without light source







A

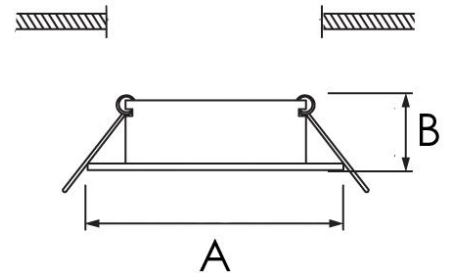

B



		INDEX			A [mm]	B [mm]	
A		010834	DELIUS	Srebrny Stieborná stříbrná silver	92	18	5902808801283
B		013093	DELIUS	Srebrny Stieborná stříbrná silver	92	18	5902808801290



GU10

IP



Materiał / Materiál / Material

PL: aluminium

CZ: hliník

SK: hliník

EN: aluminum

Brølux

www.bowi.com.pl

SATINO



OPRAWY PODTYNKOWE BEZ ŹRÓDŁA ŚWIATŁA

CZ: Podomítkové svítidla bez zdroje světla / SK: Podomietkové svetidlá bez zdroja svetla / EN
Concealed luminaires without light source



A



B

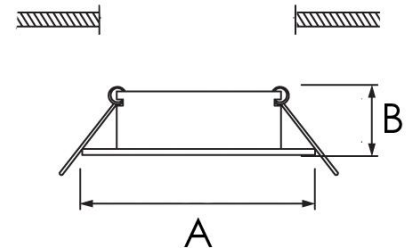

	INDEX			A [mm]	B [mm]	
A	013369	Satino	Biały biela white	92	32	5902808801306
B	009496	Satino	Czarny Černá Čierny Black	92	32	5902216711853



GU10

IP

44



15°



Materiał / Materiál / Material

PL: aluminium

CZ:hliník

SK: hliník

EN:aluminum

Br**o**lux

OPRAWY PODTYNKOWE BEZ ŹRÓDŁA ŚWIATŁA

CZ: Podomítkové svítidla bez zdroje světla / SK: Podomietkové svietidlá bez zdroja svetla / EN
Concealed luminaires without light source



A

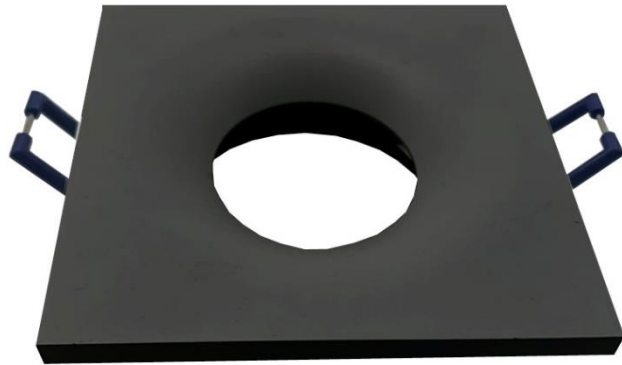

B

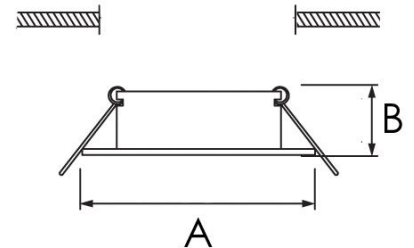

	INDEX			A [mm]	B [mm]	
A	012987	Carlito	Czarny Černá Čierny Black	97	25	5902808803928
B	012988	Carlito		90	25	5902808803935



GU10

IP

20



Materiał / Materiál / Material

PL: aluminium

CZ:hliník

SK: hliník

EN:aluminum

Br**o**lux

SIMPS



OPRAWY PODTYNKOWE BEZ ŹRÓDŁA ŚWIATŁA

CZ: Podomítkové svítidla bez zdroje světla / SK: Podomietkové svietidlá bez zdroja svetla / EN
Concealed luminaires without light source



A



B



C



D

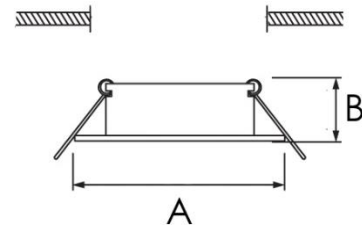

		INDEX			A [mm]	B [mm]	
A		013313	Simps	Czarny Černá Čierny Black	96	50	5902808803942
B		012992	Simps		96	50	5902808803959
C		013314	Simps	Biały bílá bielá white	96	50	5902808806585
D		012991	Simps		96	50	5902808806592



GU10

IP

20



ROHS
COMPLIANT

Materiał / Material / Material

PL: aluminium

CZ:hliník

SK: hliník

EN:aluminum

BroLux

QUATRO



OPRAWY PODTYNKOWE BEZ ŹRÓDŁA ŚWIATŁA

CZ: Podomítkové svítidla bez zdroje světla / SK: Podomietkové svietidlá bez zdroja svetla / EN
Concealed luminaires without light source



A



B



C



D



E

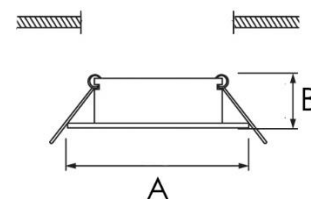

	INDEX			A [mm]	B [mm]	
A	009492	Quatro	Biały biła bielá white	84	25	5902216799103
B	013751	Quatro		90	25	5902808805502
C	013508	Quatro	Czarny Černá Čierny Black	84	25	5902808803485
D	013749	Quatro		90	25	5902808805533
E	013750	Quatro		90	25	5902808805519



GU10

IP

54



Materiał / Material / Material

PL: stal

CZ: ocel

SK: ocel'

EN: steel

BroLux

OPRAWY PODTYNKOWE BEZ ŹRÓDŁA ŚWIATŁA

CZ: Podomítkové svítidla bez zdroje světla / SK: Podomietkové svietidlá bez zdroja svetla / EN
Concealed luminaires without light source



A

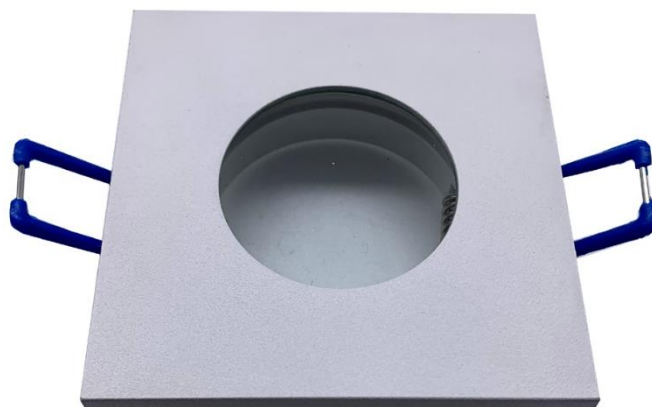

B



C



D

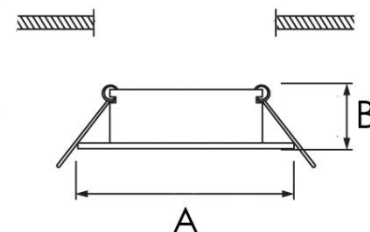

		INDEX			A [mm]	B [mm]	
A		013006	Silva	Biały biła biela white	82	26	5902808803461
B		013748	Silva		81	25	5902808805540
C		013007	Silva	Czarny Černá Čierny Black	80	25	5902808803478
D		013749	Silva		81	25	5902808805533



GU10

IP

65



Materiał / Material / Materiál

PL: aluminium

CZ:hliník

SK: hliník

EN:aluminium

Brölux

OPRAWA SUFITOWA

CZ: stropní svítidlo/ SK: stropné svetidlo/ EN: ceiling luminaire

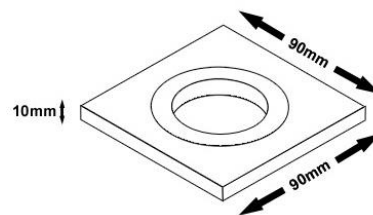
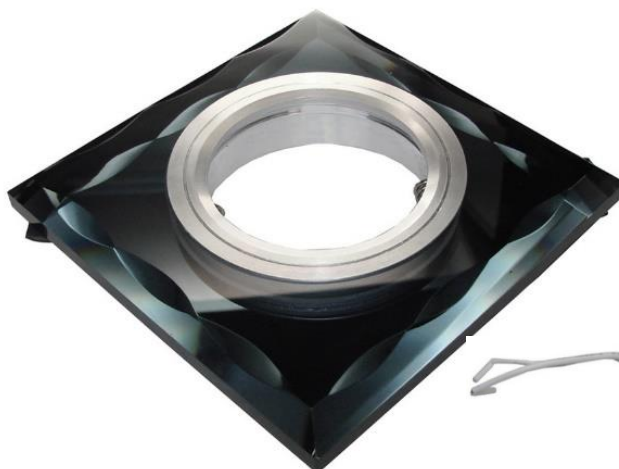

INDEX		
009460		Czarny Černá Čierna Black
009461		Niebieski Modrá Modrá Blue
009462		Żółty Złata Žltá Yellow
009463		Biały bílá bilá white
009464		Zielony Zelená Zelená Green
009465		Fioletowy Fialová Fialová Purple

Materiał / Materiál / Material

PL: Wykonana ze szkła i stopu aluminium

CZ: Vyrobeno ze skla a hliníkové slitiny

SK: Vyrobené zo skla a hliníkovej zliatiny

EN: Made of glass and aluminium alloy

Materiał / Materiál / Material

PL: - jako źródło światła stosuje się żarówki MR16/12V
- oprawka do źródła światła w zestawie
- oprawka nie zawiera źródła światła
- oprawka jest przystosowana do żarówek w klasach energetycznych A++ - E

CZ: - Žárovky MR16 / 12V se používají jako světlo
- zdroj, držák v ceně
- bez použití světelného zdroje.
- armatura je nastavena na žárovky třídy A ++ - E

SK: - Žiarovky MR16 / 12V sa používajú ako svetlo
- zdroj, držiak v cene
- zariadenie bez svetelného zdroja.
- montáž je prispôbena žiarovkám triedy A ++ - E

EN: - MR16/12V lamps are used as a light
- source,holder included
- fitting without a light source.
- fitting is adjusted to A++ - E energy class lamps



MR16

Br^olux

OPRAWA SUFITOWA

CZ: stropní svítidlo/ SK: stropné svetidlo/ EN: ceiling luminaire



INDEX		Regulacja nastavení nastavenie adjustment	Chrome plated	
004751				Czarny Černá Čierná Black
012298				Przezroczysty Průhledná Príesvitná Clear
012422		TAK		Czarny Černá Čierná Black
012423		TAK		Przezroczysty Průhledná Príesvitná Clear
012424			TAK	Przezroczysty Průhledná Príesvitná Clear

Materiał / Materiál / Material

PL: Wykonana ze szkła i stopu aluminium

CZ: Vyrobeno ze skla a hliníkové slitiny

SK: Vyrobené zo skla a hliníkovej zliatiny

EN: Made of glass and aluminium alloy

Materiał / Materiál / Material

PL: - jako źródło światła stosuje się żarówki MR16/12V

- oprawka do źródła światła w zestawie

- oprawa nie zawiera źródła światła

- oprawa jest przystosowana do żarówek w klasach energetycznych A++ - E

CZ: - Žárovky MR16 / 12V se používají jako světlo

- zdroj, držák v ceně

- bez použití světelného zdroje.

- armatura je nastavena na žárovky třídy A++ - E

SK: - Žiarovky MR16 / 12V sa používajú ako svetlo

- zdroj, držiak v cene

- zariadenie bez svetelného zdroja.

- montáž je prispôbena žiarovkám triedy A++ - E

EN: - MR16/12V lamps are used as a light

- source,holder included

- fitting without a light source.

- fitting is adjusted to A++ - E energy class lamps



MR16

Brolux

OPRAWA SUFITOWA

CZ: stropní svítidlo/ SK: stropné svetidlo/ EN: ceiling luminaire



INDEX		
002969		Szroniony Ojíněná Srieništá Frosted
009473		Biały biłá biłá white
009474		Czarny Černá Čierná Black
009475		Kawowy Kávová Kávová Coffee
009476		Żółty Złata Žltá Yellow
009477		Zielony Zelená Zelená Green
009478		Fioletowy Fialová Fialová Purple

INDEX		Regulacja nastavení nastavenie adjustment	Chrome plated	
012400		TAK		Czarny Černá Čierná Black
012401			TAK	Czarny Černá Čierná Black
012402		TAK		Szroniony Ojíněná Srieništá Frosted
012403		TAK		Biały biłá biłá white
012404			TAK	Biały biłá biłá white
012405		TAK	TAK	Biały biłá biłá white

Materiał / Materiál / Material
 PL: Wykonana ze szkła i stopu aluminium
 CZ: Vyrobeno ze skla a hliníkové slitiny
 SK: Vyrobené zo skla a hliníkovej zliatiny
 EN: Made of glass and aluminium alloy

Materiał / Materiál / Material

PL: - jako źródło światła stosuje się żarówki MR16/12V

- oprawa do źródła światła w zestawie - oprawa nie zawiera źródła światła
- oprawa jest przystosowana do żarówek w klasach energetycznych A++ - E

CZ: - Žárovky MR16 / 12V se používají jako světlo - zdroj, držák v ceně

- bez použití světelného zdroje. - armatura je nastavena na žárovky třídy A ++ - E

SK: - Žiarovky MR16 / 12V sa používajú ako svetlo - zdroj, držiak v cene

- zariadenie bez svetelného zdroja.- montáž je prispôsobená žiarovkám triedy A ++ - E

EN: - MR16/12V lamps are used as a light - source,holder included

- fitting without a light source.- fitting is adjusted to A++ - E energy class lamps



MR16

BroLux

CLIPPER



OPRAWA SUFITOWA

CZ: stropní svítidlo/ SK: stropné svietidlo/ EN: ceiling luminaire

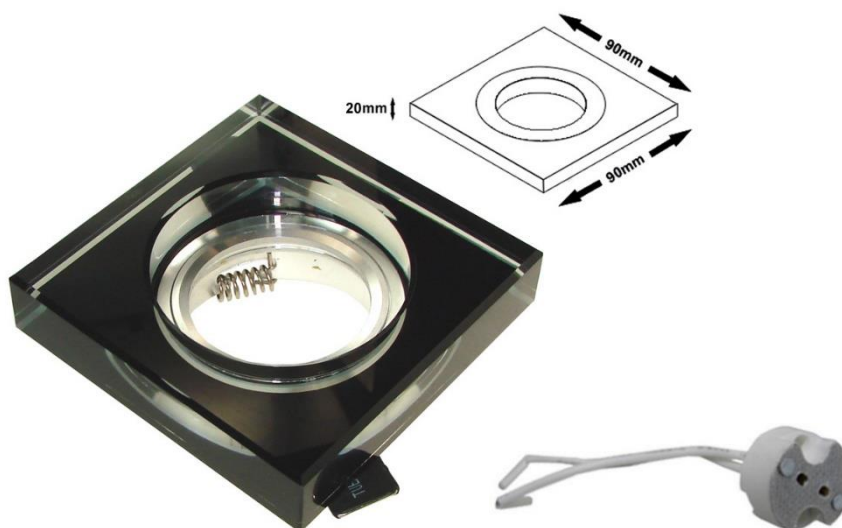

INDEX		
010837		Przezroczysty Průhledná Priesvitná Clear
010838		Czarny Černá Čierna Black

Materiał / Materiał / Material

PL: Wykonana ze szkła i stopu aluminium

CZ: Vyrobeno ze skla a hliníkové slitiny

SK: Vyrobené zo skla a hliníkovej zliatiny

EN: Made of glass and aluminium alloy

Materiał / Materiał / Material

PL: - jako źródło światła stosuje się żarówki MR16/12V
- oprawka do źródła światła w zestawie
- oprawka nie zawiera źródła światła
- oprawka jest przystosowana do żarówek w klasach energetycznych A++ - E

CZ: - Žárovky MR16 / 12V se používají jako světlo

- zdroj, držák v ceně

- bez použití světelného zdroje.

- armatura je nastavena na žárovky třídy A ++ - E

SK: - Žiarovky MR16 / 12V sa používajú ako svetlo

- zdroj, držiak v cene

- zariadenie bez svetelného zdroja.

- montáž je prispôbena žiarovkám triedy A ++ - E

EN: - MR16/12V lamps are used as a light

- source, holder included

- fitting without a light source.

- fitting is adjusted to A++ - E energy class lamps



MR16

Brulux

OPRAWA SUFITOWA

CZ: stropní svítidlo/ SK: stropné svietidlo/ EN: ceiling luminaire

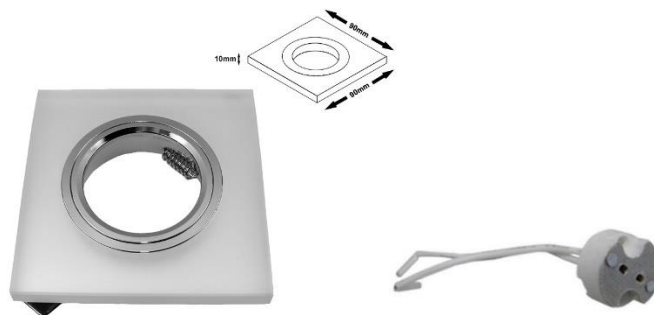

INDEX		
009468		Czarny Černá Čierná Black
009467		Niebieski Modrá Modrá Blue
009466		Przezroczysty Průhledná Priesvitná Clear
009472		Kawowy Kávová Kávová Coffee
009469		Zielony Zelená Zelená Green
009471		Fioletowy Fialová Fialová Purple
002895		Szroniony Ojíněná Srieništá Frosted
009470		Żółty Žlata Žltá Yellow

INDEX		Regulacja nastavení nastavenie adjustment	Chrome plated	
10045			TAK	Przezroczysty Průhledná Priesvitná Clear
5720		TAK		Przezroczysty Průhledná Priesvitná Clear
012408		TAK	TAK	Przezroczysty Průhledná Priesvitná Clear
6880		TAK		Czarny Černá Čierná Black
012406		TAK		Szroniony Ojíněná Srieništá Frosted
012407		TAK	TAK	Szroniony Ojíněná Srieništá Frosted
012409			TAK	Szroniony Ojíněná Srieništá Frosted



Materiał / Materiál / Material
 PL: Wykonana ze szkła i stopu aluminium
 CZ: Vyrobeno ze skla a hliníkové slitiny
 SK: Vyrobené zo skla a hliníkovej zliatiny
 EN: Made of glass and aluminium alloy

Materiał / Materiál / Material
 PL: - jako źródło światła stosuje się żarówki MR16/12V
 - oprawka do źródła światła w zestawie - oprawa nie zawiera źródła światła
 - oprawa jest przystosowana do żarówek w klasach energetycznych A++ - E
 CZ: - Žárovky MR16 / 12V se používají jako světlo - zdroj, držák v ceně
 - bez použití světelného zdroje. - armatura je nastavena na žárovky třídy A ++ - E
 SK: - Žiarovky MR16 / 12V sa používajú ako svetlo - zdroj, držák v cene
 - zariadenie bez svetelného zdroja.- montáž je prispôbena žiarovkám triedy A ++ - E
 EN: - MR16/12V lamps are used as a light - source,holder included
 - fitting without a light source.- fitting is adjusted to A++ - E energy class lamps



OPRAWA SUFITOWA

CZ: stropní svítidlo/ SK: stropné svietidlo/ EN: ceiling luminaire



INDEX		
012477		Szroniony Ojńn�n� Srienist� Frosted

Materiał / Materi l / Material

PL: Wykonana ze szkła i stopu aluminium

CZ: Vyrobeno ze skla a hlin kov  slitiny

SK: Vyroben  z skla a hlin kovej zliatiny

EN: Made of glass and aluminium alloy

Materiał / Materi l / Material

PL: - jako Źródło Źwiatła stosuje si  Źar wki MR16/12V
- oprawa do Źródła Źwiatła w zestawie
- oprawa nie zawiera Źródła Źwiatła
- oprawa jest przystosowana do Źar wek w klasach energetycznych A++ - E

CZ: - Źar vky MR16 / 12V se pouŹivaj  jako sv tlo

- zdroj, drŹi k v cen 

- bez pouŹit  sv teln ho zdroje.

- armatura je nastavena na Źar vky tŹidy A ++ - E

SK: - Źiarovky MR16 / 12V sa pouŹivaj  ako svetlo

- zdroj, drŹi k v cene

- zariadenie bez sveteln ho zdroja.

- mont Ź je prisp soben  Źiarovk m tŹiedy A ++ - E

EN: - MR16/12V lamps are used as a light

- source,holder included

- fitting without a light source.

- fitting is adjusted to A++ - E energy class lamps



MR16



BroLux

OPRAWA SUFITOWA

CZ: stropní svítidlo/ SK: stropné svetidlo/ EN: ceiling luminaire



INDEX		
012474		Przezroczysty Průhledná Priesvitná Clear
012473		Czarny Černá Čierná Black



MR16

Materiał / Materiał / Material

PL: Wykonana ze szkła i stopu aluminium

CZ: Vyrobeno ze skla a hliníkové slitiny

SK: Vyrobené zo skla a hliníkovej zliatiny

EN: Made of glass and aluminium alloy

Materiał / Materiał / Material

PL: - jako źródło światła stosuje się żarówki MR16/12V
- oprawka do źródła światła w zestawie
- oprawka nie zawiera źródła światła
- oprawka jest przystosowana do żarówek w klasach energetycznych A++ - E

CZ: - Žárovky MR16 / 12V se používají jako světlo

- zdroj, držák v ceně

- bez použití světelného zdroje.

- armatura je nastavena na žárovky třídy A ++ - E

SK: - Žiarovky MR16 / 12V sa používajú ako svetlo

- zdroj, držiak v cene

- zariadenie bez svetelného zdroja.

- montáž je prispôbena žiarovkám triedy A ++ - E

EN: - MR16/12V lamps are used as a light

- source,holder included

- fitting without a light source.

- fitting is adjusted to A++ - E energy class lamps

OPRAWA SUFITOWA

CZ: stropní svítidlo/ SK: stropné svetidlo/ EN: ceiling luminaire

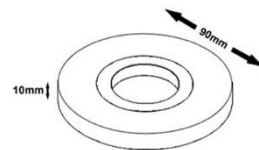

INDEX		Regulacja nastawien nastawienie adjustment	Chrome plated	
000636				Przezroczysty Průhledná Priesvitný Clear
000831				Czarna Černá Čierna Black
012410		TAK		Przezroczysty Průhledná Priesvitná Clear
012411			TAK	Przezroczysty Průhledná Priesvitná Clear
012412		TAK	TAK	Przezroczysty Průhledná Priesvitná Clear
012413		TAK		Czarna Černá Čierna Black

Materiał / Materiál / Material

PL: Wykonana ze szkła i stopu aluminium

CZ: Vyrobeno ze skla a hliníkové slitiny

SK: Vyrobené zo skla a hliníkovej zliatiny

EN: Made of glass and aluminium alloy

Materiał / Materiál / Material

PL: - jako źródło światła stosuje się żarówki MR16/12V

- oprawka do źródła światła w zestawie

- oprawa nie zawiera źródła światła

- oprawa jest przystosowana do żarówek w klasach energetycznych A++ - E

CZ: - Žárovky MR16 / 12V se používají jako světlo

- zdroj, držák v ceně

- bez použití světelného zdroje.

- armatura je nastavena na žárovky třídy A ++ - E

SK: - Žiarovky MR16 / 12V sa používajú ako svetlo

- zdroj, držák v cene

- zariadenie bez svetelného zdroja.

- montáž je prispôsobená žiarovkám triedy A ++ - E

EN: - MR16/12V lamps are used as a light

- source,holder included

- fitting without a light source.

- fitting is adjusted to A++ - E energy class lamps



MR16

Brulux

OPRAWA SUFITOWA

CZ: stropní svítidlo/ SK: stropné svetidlo/ EN: ceiling luminaire

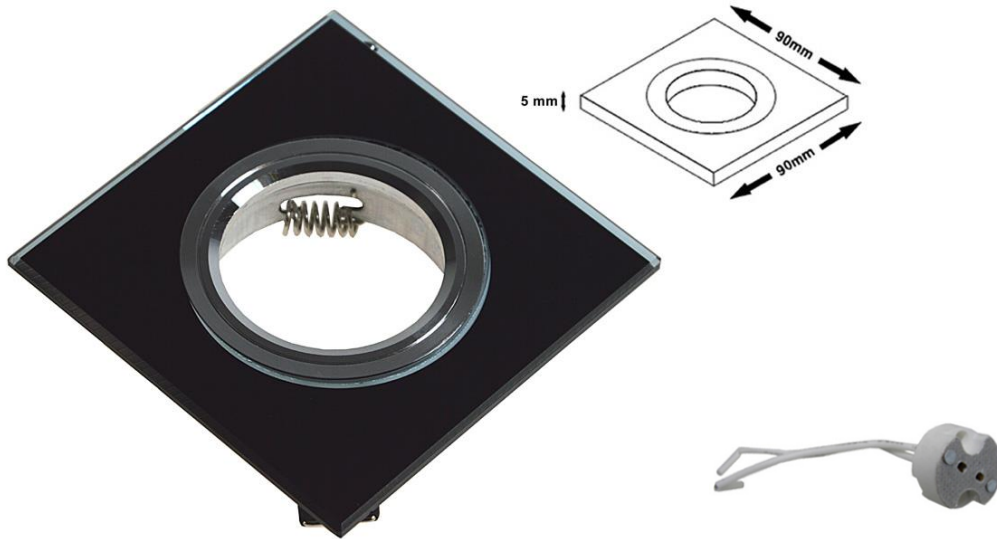

INDEX		
012828		Przezroczysty Průhledná Priesvitná Clear
012829		Czarny Černá Čierná Black

Materiał / Materiał / Materiał

PL: Wykonana ze szkła i stopu aluminium

CZ: Vyrobeno ze skla a hliníkové slitiny

SK: Vyrobené zo skla a hliníkovej zliatiny

EN: Made of glass and aluminium alloy

Materiał / Materiał / Materiał

PL: - jako źródło światła stosuje się żarówki MR16/12V
- oprawka do źródła światła w zestawie
- oprawa nie zawiera źródła światła
- oprawa jest przystosowana do żarówek w klasach energetycznych A++ - E

CZ: - Žárovky MR16 / 12V se používají jako světlo
- zdroj, držák v ceně
- bez použití světelného zdroje.
- armatura je nastavena na žárovky třídy A ++ - E

SK: - Žiarovky MR16 / 12V sa používajú ako svetlo
- zdroj, držiak v cene
- zariadenie bez svetelného zdroja.
- montáž je prispôsobená žiarovkám triedy A ++ - E

EN: - MR16/12V lamps are used as a light
- source,holder included
- fitting without a light source.
- fitting is adjusted to A++ - E energy class lamps



MR16

OPRAWA SUFITOWA

CZ: stropní svítidlo/ SK: stropné svietidlo/ EN: ceiling luminaire

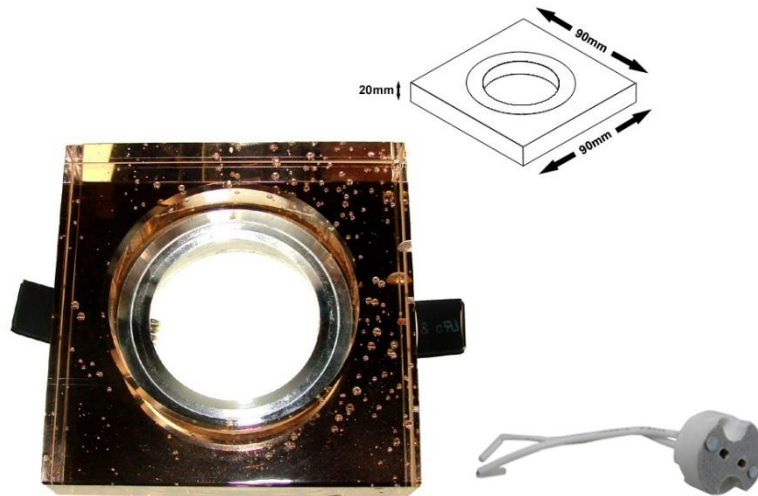

INDEX		
010835		Kawowy Kávová Kávová Coffee
007470		Czarny Černá Čierná Black

Materiał / Materiał / Material

PL: Wykonana ze szkła i stopu aluminium

CZ: Vyrobeno ze skla a hliníkové slitiny

SK: Vyrobené zo skla a hliníkovej zliatiny

EN: Made of glass and aluminium alloy

Materiał / Materiał / Material

PL: - jako źródło światła stosuje się żarówki MR16/12V
- oprawka do źródła światła w zestawie
- oprawa nie zawiera źródła światła
- oprawa jest przystosowana do żarówek w klasach energetycznych A++ - E

CZ: - Žárovky MR16 / 12V se používají jako světlo
- zdroj, držák v ceně
- bez použití světelného zdroje.
- armatura je nastavena na žárovky třídy A ++ - E

SK: - Žiarovky MR16 / 12V sa používajú ako svetlo
- zdroj, držiak v cene
- zariadenie bez svetelného zdroja.
- montáž je prispôsobená žiarovkám triedy A ++ - E

EN: - MR16/12V lamps are used as a light
- source,holder included
- fitting without a light source.
- fitting is adjusted to A++ - E energy class lamps



MR16

OPRAWA SUFITOWA

CZ: stropní svítidlo/ SK: stropné svetidlo/ EN: ceiling luminaire

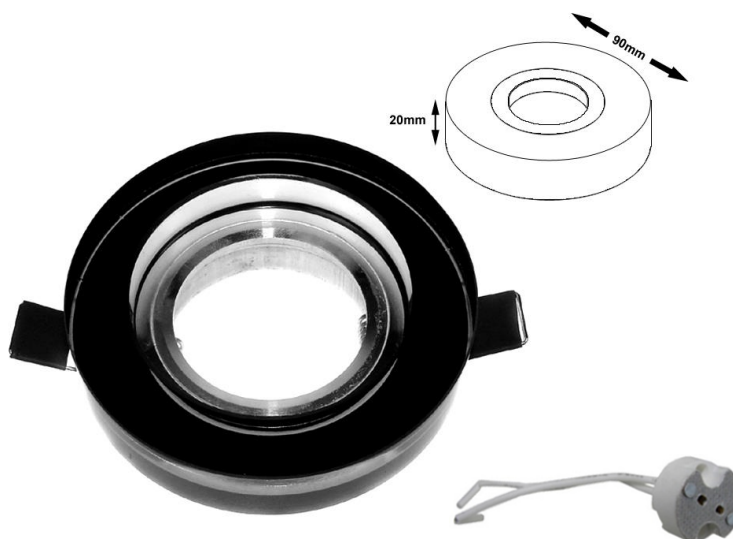

INDEX		
010839		Przezroczysty Průhledná Priesvitná Clear
010840		Czarny Černá Čierna Black

Materiał / Materiál / Material

PL: Wykonana ze szkła i stopu aluminium

CZ: Vyrobeno ze skla a hliníkové slitiny

SK: Vyrobené zo skla a hliníkovej zliatiny

EN: Made of glass and aluminium alloy

Materiał / Materiál / Material

PL: - jako źródło światła stosuje się żarówki MR16/12V
- oprawa do źródła światła w zestawie
- oprawa nie zawiera źródła światła
- oprawa jest przystosowana do żarówek w klasach energetycznych A++ - E

CZ: - Žárovky MR16 / 12V se používají jako světlo
- zdroj, držák v ceně
- bez použití světelného zdroje.
- armatura je nastavena na žárovky třídy A ++ - E

SK: - Žiarovky MR16 / 12V sa používajú ako svetlo
- zdroj, držiak v cene
- zariadenie bez svetelného zdroja.
- montáž je prispôsobená žiarovkám triedy A ++ - E

EN: - MR16/12V lamps are used as a light
- source,holder included
- fitting without a light source.
- fitting is adjusted to A++ - E energy class lamps



MR16

Brolux

OPRAWA SUFITOWA

CZ: stropní svítidlo/ SK: stropné svietidlo/ EN: ceiling luminaire

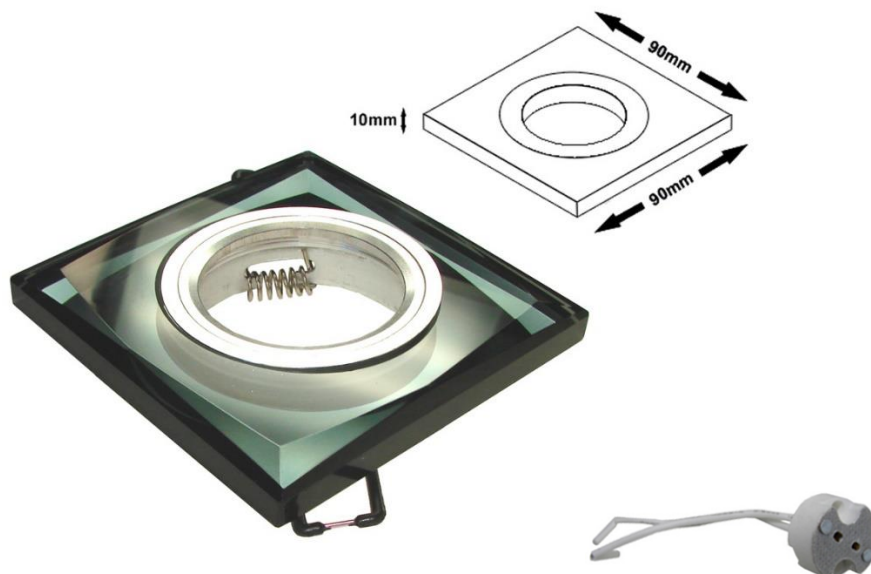

INDEX		Regulacja nastavení nastavenie adjustment	
010836			Czarny Černá Čierna Black
010841			Przezroczysty Průhledná Priesvitná Clear
012414		TAK	Przezroczysty Průhledná Priesvitná Clear

Materiał / Material / Material

PL: Wykonana ze szkła i stopu aluminium

CZ: Vyrobeno ze skla a hliníkové slitiny

SK: Vyrobené zo skla a hliníkovej zliatiny

EN: Made of glass and aluminium alloy

Materiał / Material / Material

PL: - jako źródło światła stosuje się żarówki MR16/12V

- oprawka do źródła światła w zestawie

- oprawa nie zawiera źródła światła

- oprawa jest przystosowana do żarówek w klasach energetycznych A++ - E

CZ: - Žárovky MR16 / 12V se používají jako světlo

- zdroj, držák v ceně

- bez použití světelného zdroje.

- armatura je nastavena na žárovky třídy A++ - E

SK: - Žiarovky MR16 / 12V sa používajú ako svetlo

- zdroj, držák v cene

- zariadenie bez svetelného zdroja.

- montáž je prispôbena žiarovkám triedy A++ - E

EN: - MR16/12V lamps are used as a light

- source,holder included

- fitting without a light source.

- fitting is adjusted to A++ - E energy class lamps



MR16

OPRAWA SUFITOWA

CZ: stropní svítidlo/ SK: stropné svetidlo/ EN: ceiling luminaire

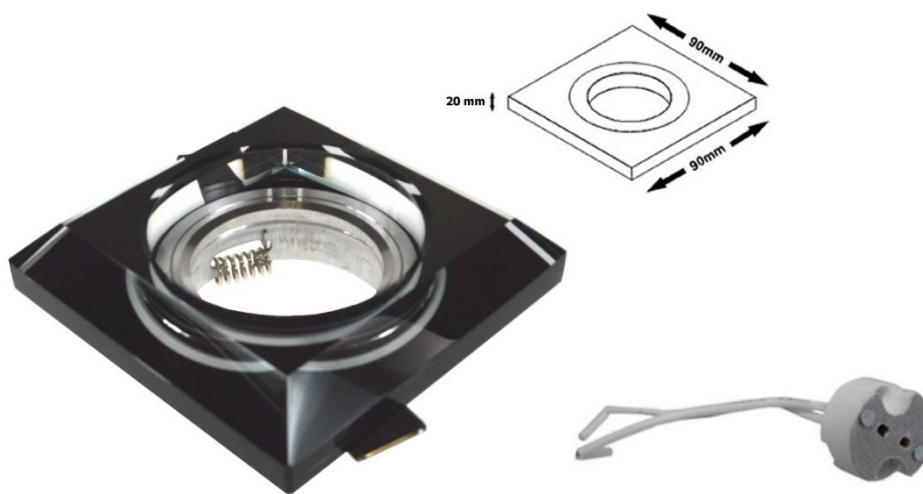

INDEX		
012476		Czarny Černá Čierna Black
012475		Przezroczysty Průhledná Priesvitná Clear

Materiał / Material / Material

PL: Wykonana ze szkła i stopu aluminium

CZ: Vyrobeno ze skla a hliníkové slitiny

SK: Vyrobené zo skla a hliníkovej zliatiny

EN: Made of glass and aluminium alloy

Materiał / Material / Material

PL: - jako źródło światła stosuje się żarówki MR16/12V
- oprawa do źródła światła w zestawie
- oprawa nie zawiera źródła światła
- oprawa jest przystosowana do żarówek w klasach energetycznych A++ - E

CZ: - Žárovky MR16 / 12V se používají jako světlo
- zdroj, držák v ceně
- bez použití světelného zdroje.
- armatura je nastavena na žárovky třídy A ++ - E

SK: - Žiarovky MR16 / 12V sa používajú ako svetlo
- zdroj, držiak v cene
- zariadenie bez svetelného zdroja.
- montáž je prispôbena žiarovkám triedy A ++ - E

EN: - MR16/12V lamps are used as a light
- source,holder included
- fitting without a light source.
- fitting is adjusted to A++ - E energy class lamps



MR16



RoHS COMPLIANT

OPRAWA SUFITOWA

CZ: stropní svítidlo/ SK: stropné svietidlo/ EN: ceiling luminaire

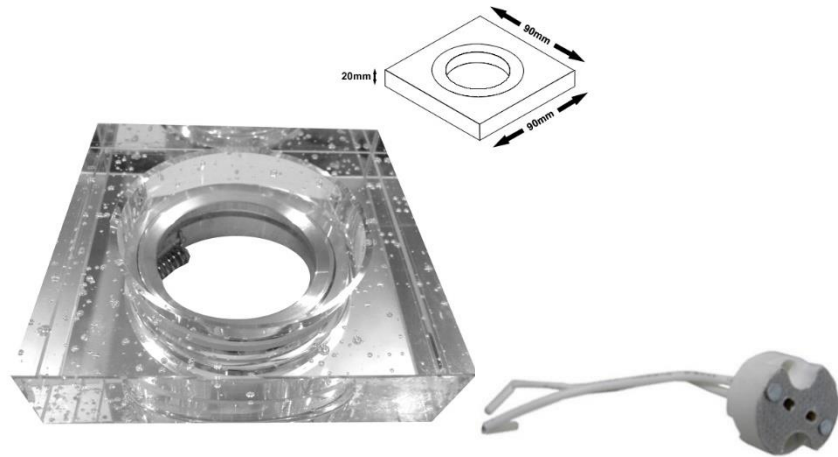

INDEX		
009481		Różowy Růžová Ružová Pink
009483		Czarny Černá Čierná Black
009480		Żółty Žlata Žltá Yellow
009482		Przezroczysty Průhledná Priesvitná Clear

Materiał / Material / Material

PL: Wykonana ze szkła i stopu aluminium

CZ: Vyrobeno ze skla a hliníkové slitiny

SK: Vyrobené zo skla a hliníkovej zliatiny

EN: Made of glass and aluminium alloy

Materiał / Material / Material

PL: - jako źródło światła stosuje się żarówki MR16/12V
- oprawa do źródła światła w zestawie
- oprawa nie zawiera źródła światła
- oprawa jest przystosowana do żarówek w klasach energetycznych A++ - E

CZ: - Žárovky MR16 / 12V se používají jako světlo
- zdroj, držák v ceně
- bez použití světelného zdroje.
- armatura je nastavena na žárovky třídy A ++ - E

SK: - Žiarovky MR16 / 12V sa používajú ako svetlo
- zdroj, držiak v cene
- zariadenie bez svetelného zdroja.
- montáž je prispôsobená žiarovkám triedy A ++ - E

EN: - MR16/12V lamps are used as a light
- source,holder included
- fitting without a light source.
- fitting is adjusted to A++ - E energy class lamps



MR16

OPRAWA SUFITOWA

CZ: stropní svítidlo/ SK: stropné svietidlo/ EN: ceiling luminaire

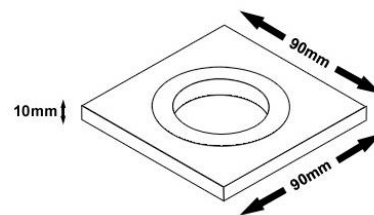

INDEX		Regulacja nastawienia nastavenie adjustment	Chrome plated	
001730			TAK	Szroniony Ojinięta Srebrzysta Frosted
007665		TAK		Czarny Černá Čierna Black
007666		TAK		Przezroczysty Průhledná Priesvitná Clear
012389		TAK	TAK	Przezroczysty Průhledná Priesvitná Clear
012415		TAK	TAK	Szroniony Ojinięta Srebrzysta Frosted
012416			TAK	Przezroczysty Průhledná Priesvitná Clear
012417			TAK	Czarny Černá Čierna Black
012418		TAK		Przezroczysty Průhledná Priesvitná Clear
012420		TAK		Czarny Černá Čierna Black

INDEX		
004773		Kawowy Kávová Kávová Coffee
5484		Czarny Černá Čierna Black
5490		Przezroczysty Průhledná Priesvitná Clear
6169		
6173		
012419		Przezroczysty Průhledná Priesvitná Clear
012421		Czarny Černá Čierna Black



MR16



RoHS COMPLIANT

Materiał / Materiál / Material

PL: Wykonana ze szkła i stopu aluminium

CZ: Vyrobeno ze skla a hliníkové slitiny

SK: Vyrobené zo skla a hliníkovej zliatiny

EN: Made of glass and aluminium alloy

Materiał / Materiál / Material

PL: - jako źródło światła stosuje się żarówki MR16/12V
- oprawa do źródła światła w zestawie
- oprawa nie zawiera źródła światła
- oprawa jest przystosowana do żarówek w klasach energetycznych A++ - E

CZ: - Žárovky MR16 / 12V se používají jako světlo
- zdroj, držák v ceně
- bez použití světelného zdroje.
- armatura je nastavena na žárovky třídy A ++ - E

SK: - Žiarovky MR16 / 12V sa používajú ako svetlo
- zdroj, držák v cene
- zariadenie bez svetelného zdroja.
- montáž je prispôbena žiarovkám triedy A ++ - E

EN: - MR16/12V lamps are used as a light
- source, holder included
- fitting without a light source.
- fitting is adjusted to A++ - E energy class lamps

OPRAWA SUFITOWA

CZ: stropní svítidlo/ SK: stropné svetidlo/ EN: ceiling luminaire



INDEX		Regulacja nastavení nastavenie adjustment	Nickel plated	
008873		TAK	TAK	Stalowa Ocelová Ocelová Steel
008738		TAK		Biały biła biła white
012947		TAK		Srebrny Stříbra Stříbrná Silver

Materiał / Materiál / Material

PL: Stal

CZ: Ocel

SK: Ocel'

EN: Steel

Materiał / Materiál / Material

PL: - jako źródło światła stosuje się żarówki MR16/12V

- oprawka do źródła światła w zestawie

- oprawa nie zawiera źródła światła

- oprawa jest przystosowana do żarówek w klasach energetycznych A++ - E

CZ: - Žárovky MR16 / 12V se používají jako světlo

- zdroj, držák v ceně

- bez použití světelného zdroje.

- armatura je nastavena na žárovky třídy A ++ - E

SK: - Žiarovky MR16 / 12V sa používajú ako svetlo

- zdroj, držák v cene

- zariadenie bez svetelného zdroja.

- montáž je prispôbena žiarovkám triedy A ++ - E

EN: - MR16/12V lamps are used as a light

- source,holder included

- fitting without a light source.

- fitting is adjusted to A++ - E energy class lamps



MR16

Brolux

OPRAWA SUFITOWA

CZ: stropní svítidlo/ SK: stropné svetidlo/ EN: ceiling luminaire



INDEX		
012948		Biały biła biła white
012949		Srebrny Srebro Srebrná Silver
008736		Biały biła biła white
012946		Srebrny matowy Srebro matná Srebrná matná Silver matte
012945		Srebrny Srebro Srebrná Silver

Materiał / Materiál / Material

PL: Stal

CZ: Ocel

SK: Ocel'

EN: Steel

Materiał / Materiál / Material

PL: - jako źródło światła stosuje się żarówki MR16/12V

- oprawka do źródła światła w zestawie

- oprawa nie zawiera źródła światła

- oprawa jest przystosowana do żarówek w klasach energetycznych A++ - E

CZ: - Žárovky MR16 / 12V se používají jako světlo

- zdroj, držák v ceně

- bez použití světelného zdroje.

- armatura je nastavena na žárovky třídy A ++ - E

SK: - Žiarovky MR16 / 12V sa používajú ako svetlo

- zdroj, držák v cene

- zariadenie bez svetelného zdroja.

- montáž je prispôbena žiarovkám triedy A ++ - E

EN: - MR16/12V lamps are used as a light

- source,holder included

- fitting without a light source.

- fitting is adjusted to A++ - E energy class lamps



MR16

Brolux

OPRAWA SUFITOWA

CZ: stropní svítidlo/ SK: stropné svetidlo/ EN: ceiling luminaire



INDEX		Nickel plated	
008752		TAK	Stalowa Ocelová Ocelová Steel

Materiał / Material / Material

PL: Stal

CZ: Ocel

SK: Ocel'

EN: Steel

Materiał / Material / Material

PL: - jako źródło światła stosuje się żarówki MR16/12V
 - oprawka do źródła światła w zestawie
 - oprawa nie zawiera źródła światła
 - oprawa jest przystosowana do żarówek w klasach energetycznych A++ - E

CZ: - Žárovky MR16 / 12V se používají jako světlo
 - zdroj, držák v ceně
 - bez použití světelného zdroje.
 - armatura je nastavena na žárovky třídy A ++ - E

SK: - Žiarovky MR16 / 12V sa používajú ako svetlo
 - zdroj, držák v cene
 - zariadenie bez svetelného zdroja.
 - montáž je prispôbena žiarovkám triedy A ++ - E

EN: - MR16/12V lamps are used as a light
 - source,holder included
 - fitting without a light source.
 - fitting is adjusted to A++ - E energy class lamps



MR16

Br^olux

OPRAWA SUFITOWA

CZ: stropní svítidlo/ SK: stropné svietidlo/ EN: ceiling luminaire



INDEX		Regulacja nastavení nastavenie adjustment	Nickel plated	
008753		TAK	TAK	Stalowa Ocelová Ocelová Steel

Materiał / Material / Material

PL: Stal

CZ: Ocel

SK: Ocel'

EN: Steel

Materiał / Material / Material

PL: - jako źródło światła stosuje się żarówki MR16/12V

- oprawka do źródła światła w zestawie

- oprawa nie zawiera źródła światła

- oprawa jest przystosowana do żarówek w klasach energetycznych A++ - E

CZ: - Žárovky MR16 / 12V se používají jako světlo

- zdroj, držák v ceně

- bez použití světelného zdroje.

- armatura je nastavena na žárovky třídy A ++ - E

SK: - Žiarovky MR16 / 12V sa používajú ako svetlo

- zdroj, držák v cene

- zariadenie bez svetelného zdroja.

- montáž je prispôbena žiarovkám triedy A ++ - E

EN: - MR16/12V lamps are used as a light

- source,holder included

- fitting without a light source.

- fitting is adjusted to A++ - E energy class lamps





MR16

Brolux

OPRAWA SUFITOWA

CZ: stropní svítidlo/ SK: stropné svetidlo/ EN: ceiling luminaire



INDEX		Regulacja nastavení nastavenie adjustment	Nickel plated		Materiał / Material / Material
008783		TAK	TAK	Stalowa Ocelová Ocelová Steel	PL: Stal CZ: Ocel SK: Ocel' EN: Steel

Materiał / Material / Material

PL: - jako źródło światła stosuje się żarówki MR16/12V
 - oprawka do źródła światła w zestawie
 - oprawa nie zawiera źródła światła
 - oprawa jest przystosowana do żarówek w klasach energetycznych A++ - E

CZ: - Žárovky MR16 / 12V se používají jako světlo
 - zdroj, držák v ceně
 - bez použití světelného zdroje.
 - armatura je nastavena na žárovky třídy A ++ - E

SK: - Žiarovky MR16 / 12V sa používajú ako svetlo
 - zdroj, držák v cene
 - zariadenie bez svetelného zdroja.
 - montáž je prispôbena žiarovkám triedy A ++ - E

EN: - MR16/12V lamps are used as a light
 - source,holder included
 - fitting without a light source.
 - fitting is adjusted to A++ - E energy class lamps



MR16

Brolux

OPRAWKI SZKLANE

OPRAWKI

CZ: podhledové bodové svítidlo / SK: podhľadové bodové svietidlo / EN: Ceiling fixture



009498



009493



009489



009499



009487



009501



009486



009484



009494



009479



009502



009495



009490



009503



007664



009496



009504



009485

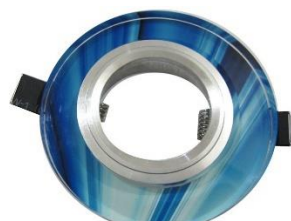

009488



009497



009505



009506



009507



009508

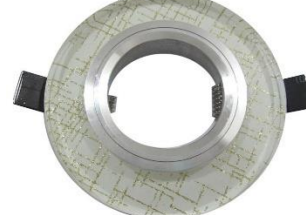

009509

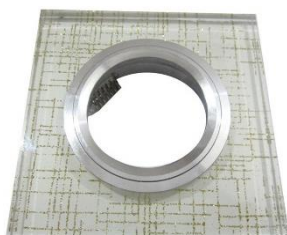

009510

OPRAWKI

CZ: podhledové bodové svítidlo / SK: podhľadové bodové svietidlo / EN: Ceiling fixture



008739



008734



008735



008751



008754



008756



008758



008721



008720



008722



008725



008723



008726



008727



008731



008732



008671



008687



008715



008669



008613

OPRAWY PRZYSCHODOWE

CZ: schodišťové svítidlo / SK: schodiskové svietidlo / EN staircase luminaire



INDEX	ABC			Tc[K]		A [mm]	B [mm]	C [mm]	
013642	KORA LED	1,2	44.9 lm/W	4000 K	Antracytowy RAL 7016 antracitová RAL 7016 antracitová RAL 7016 anthracite RAL 7016	150	60	28	5902808804499
013641	KORA LED	1,2	44.9 lm/W	4000 K	Czarny Černá Čierná Black	150	60	28	5902808804505

AC 230V	SMD	57°	NON-DIM
CRI(Ra)	40000 h	IP	IN&OUT
>75	CE	RoHS COMPLIANT	

Materiał / Materiál / Material

PL: aluminium

CZ: hliník

SK: hliník

EN: aluminium

Uwagi / Komentář / Komentáre

PL: Zasilacz w komplecie

CZ: Napájení je součástí dodávky

SK: Napájanie je súčasťou dodávky

EN: Power supply included

OPRAWY PRZYSCHODOWE

CZ: schodišťové svítidlo / SK: schodiskové svietidlo / EN staircase luminaire



INDEX	ABC			Tc[K]		A [mm]	B [mm]	C [mm]	
013552	STEP LED	1,2	28.3 lm/W	4000 K	Czarny Černá Čierna Black	100	100	26	5902808803492

AC 230V	SMD	57°	NON-DIM
CRI/Ra	40000 h	IP	IN&OUT
>75		54	

Materiał / Materiál / Material

PL: aluminium

CZ: hliník

SK: hliník

EN: aluminium

Uwagi / Komentář / Komentáre

PL: Zasilacz w komplecie

CZ: Napájení je součástí dodávky

SK: Napájanie je súčasťou dodávky

EN: Power supply included

UGRA

OPRAWY PRZYSCHODOWE

CZ: schodišťové svítidlo / SK: schodiskové svietidlo / EN staircase luminaire



A



B

	INDEX	ABC			Tc[K]			A [mm]	B [mm]	C [mm]	
A	013673	UGRA LED	2 W	63.9 lm/W	4000 K	Antracytowy RAL 7016 antracitová RAL 7016	72	72	45	5902808804369	
B	013672	UGRA LED	2 W	63.9 lm/W	4000 K	antracitová RAL 7016 anthracite RAL 7016	72	72	45	5902808804376	

AC 230V	SMD	57°	NON-DIM
CRI/Ra	40000 h	IP	IN&OUT
>80 icon"/>			
>80	CE	RoHS COMPLIANT	

Materiał / Materiál / Material

PL: aluminium

CZ: hliník

SK: hliník

EN: aluminium

Uwagi / Komentář / Komentáre

PL: Zasilacz w komplecie

CZ: Napájení je součástí dodávky

SK: Napájanie je súčasťou dodávky

EN: Power supply included

BroLux

www.bowi.com.pl



PROFESSIONAL
I M P O R T E R

PHU BOWI
ul. Magazynowa 7
80-180 Gdańsk-Kowale
NIP 5891414986

tel. +48 58 554 83 17

fax. +48 58 554 85 11

info@bowi.com.pl

www.bowi.com.pl