



Oświetlenie LED OUTDOOR

Osvětlení LED \ Osvetlenie LED \ LED Lighting

Katalog produktów 2018-2019

Katalog výrobků 2018-2019 \ Katalóg výrobkov 2018-2019 \ Products catalogue 2018-2019

	ZASILANIE CZ: NAPÁJENÍ SK: NAPÁJANIE EN: VOLTAGE
	MOC CZ: PŮJIKON SK: PRÍKON EN: POWER
	TEMPERATURA KOLORU CZ: TEPLOTA CHROMATICKNOSTI SK TEPLOTA CHROMATICKNOSTI EN: COLOR TEMPERATURE
	WSPÓŁCZYNNIK ODDAWANIA BARW CZ INDEX REPRODUKCE BAREV SK INDEX REPRODUKCE FARIEB EN: COLOR RENDERING INDEX
	ŚCIEMNIALNY CZ: STMIVATELNÉ SK: STMIEVATELNÉ EN: DIMMABLE
	NIEŚCIEMNIALNY CZ: NESTMIVATELNÉ SK: NIE JE STMIEVATELNÁ EN: NON DIMMABLE
	RODZAJ DIOD CZ: TYP LED SK: TYP LED EN: TYPE OF LEDS
	STRUMIEŃ ŚWIATŁA CZ: SVĚTELNÍ TOK SK: SVĚTELNÍ TOK EN LUMINOUS FLUX
	KĄT ROZSYŁU ŚWIATŁA CZ: VYZAŘOVACÍ ÚHEL SK: VYZAŘOVACÍ ÚHOL EN ANGLES OF LIGHT DISTRIBUTION
	WSPÓŁCZYNNIK MOCY CZ: FAKTOR SÍLY SK: ÚČINNÍK EN POWER FACTOR
	I KLASA OCHRONNOŚCI CZ I TRÍDA OCHRANY SK: I RIEDA OCHRANY EN: I APPLIANCE CLASS
	II KLASA OCHRONNOŚCI CZ II TRÍDA OCHRANY SK: II RIEDA OCHRANY EN: II APPLIANCE CLASS
	III KLASA OCHRONNOŚCI CZ: III TRÍDA OCHRANY SK: III RIEDA OCHRANY EN: III APPLIANCE CLASS
	NAZWA PRODUKTU CZ: NÁZEV VÝROBKU SK: NÁZOV VÝROBKU EN: NAME OF PRODUCT
	CZUJNIK RUCHU CZ: POHYBOVÝ SENZOR SK: POHYBOVÝ SENZOR EN MOTION SENSOR
	FUNKCJA KORYTARZOWA CZ: CHODBA FUNKCE SK FUNKCIA KORIDORU EN: CORRIDOR FUNCTION
	CZUJNIK ZMIERZCHOWY CZ: SÚMARKOVÉ ČIDLO SK: SOUARKOVÉ ČIDLO EN: DUSK SENSOR
	KOD KRESKOWY CZ: ČÁROVÝ KÓD SK: ČÍAROVÝ KÓD EN BARCODE
	ZDJĘCIE CZ: FOTOGRAFIE SK: FOTOGRAFIE EN: PHOTOGRAPHY
	WYMIARY CZ: ROZMERY SK: ROZMERY EN: DIMENSIONS
	MATERIAŁ OBUDOWY CZ: MATERIÁL POUZDRA SK: MATERIÁL KRYTU EN: STUFF OF CASE
	KOLOR OBUDOWY CZ BARVA POUZDRA SK: FARIEB KRYTU EN: COLOUR OF CASE
	REDUKCJA MOCY CZ: SNÍŽENÍ VÝKONU SK: ZNÍŽENIE VÝKONU EN: POWER REDUCTION
	RODZAJ TRZONKA ŽARÓVKI CZ: TYP ZÁVITU ŽÁROVEK SK: TYP ZÁVITU ŽIAROVIEK EN: SHAFT TYPE OF BULBS

	NICHIA LED CZ: NICHIA LED SK: NICHIA LED EN: NICHIA LED
	PHILIPS LED CZ: PHILIPS LED SK: PHILIPS LED EN: PHILIPS LED
	SAMSUNG LED CZ: SAMSUNG LED SK: SAMSUNG LED EN: SAMSUNG LED
	CE CZ: CE SK: CE EN: CE
	ROHS CZ: ROHS SK: ROHS EN: ROHS
	PRODUKT DO UŻYTKU WEWNĘTRZNEGO CZ: K VNITRNÍMU POUŽITÍ SK: K VNÚTRONÉMU POUŽITIU EN: FOR INTERNAL USE
	PRODUKT DO UŻYTKU WEWNĘTRZNEGO I ZEWNĘTRZNEGO CZ: K VNITRNÍMU NEBO VENKOVNÍMU POUŽITÍ SK: K VNÚTRONÉMU ALEBO VONKAJŠIEMU POUŽITIU EN: FOR EXTERNAL AND INTERNAL USE
	STOPIEŃ SZCZELNOŚĆ CZ: STUPIEŇ KRYTÍ SK: STUPIEŇ KRYTA EN: LEAKPROOFNESS
	OKRES TRWAŁOŚCI CZ: ŽIVOTNOST SK: ŽIVOTNOST EN: SUSTAINABILITY
	TEMPERATURA UŻYTKOWANIA CZ: PRACOVNÍ TEPLOTA SK: PRACOVNÁ TEPLOTA EN: WORKING TEMPERATURE
	NAPIĘCIE WEJŚCIOWE CZ: VSTUPNÍ NAPĚTÍ SK: VSTUPNÉ NAPĚTIE EN: INPUT VOLTAGE
	NAPIĘCIE WYJŚCIOWE CZ: VÝSTUPNÍ NAPĚTÍ SK: VÝSTUPNÉ NAPĚTIE EN: OUTPUT VOLTAGE
	PRĄD WYJŚCIOWY CZ: VÝSTUPNÍ PROUD SK: VÝSTUPNÝ PRŮD EN: CURRENT OUTPUT
	NAPIĘCIE TĘTNIENÍ CZ: NAPĚTÍ ZVLNĚNÍ SK: NAPĚTIE ZVLNENIA EN: VOLTAGE RIPPLE
	DŁUGOŚĆ KABLA CZ: DÉLKA KABELU SK: DĹŽKA KÁBLA EN: CABLE LENGTH
	ZAKRES REGULACJI CZ: ROZSAH NASTAVENÍ SK: ROZSAH NASTAVENIA EN: ADJUSTMENT RANGE
	TOLERANCJA NAPIĘCIA CZ: TOLERANCE NAPĚTÍ SK: TOLERANCIA NAPĚTIA EN: VOLTAGE TOLERANCE
	LICZBA PRZYCISKÓW PILOTA CZ: POČET TLAČÍTEK DÁLKOVÉHO OVLÁDÁNÍ SK: POČET TLAČIDIEL DIALKOVÉHO OVLÁDANIA EN: NUMBER OF REMOTE CONTROL BUTTONS
	DŁUGOŚĆ TAŚMY RGB CZ: DÉLKA RGB TAPES SK: DĹŽKA RGB TAPES EN: LENGTH OF RGB TAPES
	CZĘSTOTLIWOŚĆ CZ: FREKVENCE SK: FREKVENCIA EN: FREQUENCY
	ZASIĘG PILOTA CZ: ŘÁDY DÁLKOVÉHO OVLÁDÁNÍ SK: DIALKOVÉ RIADENIE RIADENIA EN: REMOTE CONTROL RANGE



STR

	Lampy high Bay CZ: Průmyslová svítidla LED HIGH BAY / SK: Priemyselná lampa / EN: LED high bay	4
	Lampy uliczne CZ: LED pouliční lampa / SK: LED pouličné lampy / EN: LED street lamp	38
	Lampy parkowe CZ: park LED lampy / SK: park LED žiarovky / EN: park LED lamps	66
	Naświetlacze CZ: vedl světlomet / SK: vedie svetlomet / EN: LED floodlight	71
	Wallwasher CZ: LED dioda na stěnové podložce / SK: LED dióda na stenách / EN: LED wallwasher	86
	Oprawy dogruntowe CZ: svítidlo dogruntové / SK: svietidlo dogruntové / EN: In ground light	88
	Reflektory LED CZ: LED světlometry / SK LED bodové svetlá / EN: LED floodlight	92
	Oprawy elewacyjne CZ: fasádní lampy LED / SK: fasádne LED svietidlá / EN: elevational LED lamps	94
	Oprawy ścienne bez źródła światła CZ: Svítidla bez zdroje světla / SK: Svietidlá bez zdroja svetla / EN: Luminaires without a light source	113
	Oprawy solarne CZ: Solární svítidla / SK: Slnecné svietidlá / EN: Solar luminaires	154
	Słupki CZ: Sloupky / SK: stĺpiky / EN: posts	156
	Oprawy LED CZ: LED svítidlo / SK: LED svietidlo / EN: LED lamp	167
	Oprawy przyschodowe CZ: schodiškové svítidlo / SK: schodiskové svietidlo / EN: staircase luminaire	170

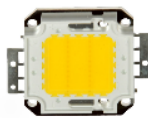

Diody

CZ: LED diody/ SK: LED diódy / EN: LED

173



Czujniki ruchu

CZ: snímače pohybu / SK: snímač pohybu / EN: motion sensor

176



Czujniki zmierzchowe

CZ: snímač soumraku/ SK: snímač súmraku/ EN: twilight sensor

179



Kontrolery

CZ: LED kontroléry / SK: LED kontroléry / EN: LED controllers

181



Reflektorki samochodowe

CZ: LED světlomety/ SK: LED bodové svetlá/ EN: LED spotlights

202



Lampy ostrzegawcze

CZ: výstražných světel / SK: výstražné svetlá / EN: warning lamps

207



Latarki

CZ: baterka s baterií/ SK: baterku s batériou / EN: flashlight with battery

208



Zasilacze

CZ: Napájecí zdroje s konstantním napětím/ SK: Napájacie zdroje s konštantným napätím/ EN: LED power supply constant voltage

212



Wtyki i gniazda DC

CZ: DC zásuvky / SK: DC zásuvky/ EN: female DC

234

JUNO



HIGH BAY LED ŚCIEMIALNY 1-10V

CZ: Průmyslová svítidla LED HIGH BAY / SK: Priemyselna lampa / EN: LED high bay

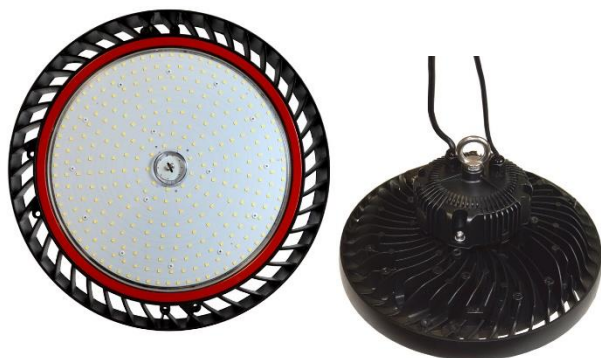

Driver

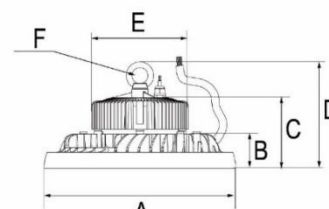

Tolerancja strumienia świetlnego +/- 10%
Średnia żywotność źródła światła L80B10 dla 70000h

INDEX	ABC					PF	Tc[K]		A [mm]	B [mm]	C [mm]	D [mm]	A [mm]	E [mm]	F [mm]	
012381	JUNO LED	100W	16 500 lm	165lm/W	0.95	4000 K	Czarny Černá Čierna Black		360	65	122	180	Ø124	Ø25	5902216796638	
011471	JUNO LED	100W	16 500 lm	165lm/w	0.95	5700K			360	65	122	180	Ø124	Ø25	5902216729636	
011800	JUNO LED	150W	23 250lm	155lm/w	0.95	4000 K			360	65	122	180	Ø142	Ø25	5902216788206	
006993	JUNO LED	150W	23 250 lm	155lm/w	0.95	5700K			360	65	122	180	Ø142	Ø25	5902216729612	
011799	JUNO LED	200W	30 000 lm	150lm/w	0.95	4000 K			360	65	122	180	Ø166	Ø25	5902216788213	
9304	JUNO LED	200W	30 000 lm	150lm/w	0.95	5700K			360	65	122	187	Ø166	Ø25	5902216729599	
011577	JUNO LED	240W	31 200 lm	130lm/w	0.95	5700K			360	65	122	187	Ø166	Ø25	5902216773912	

Dostępne Akcesoria:

AC 230V	SMD LED	120°	1-10 V
>80	70000 h	65	10
IN&OUT			



007115 Soczewka Lens 50°



010812 Soczewka Lens 90°



003745 Soczewka Lens 120°



006992 Soczewka Lens 150°



012130 Uchwyt do lampy LED high bay Juno I



012131 Uchwyt do lampy LED high bay Juno I

Materiał / Materiál / Material

PL: aluminium

CZ: hliník

SK: hliník

EN: aluminum

Optymalne warunki eksploatacji:

Optimální provozní podmínky:

Optimálne prevádzkové podmienky:

Optimal operating conditions:

PL: temperatura.: od -25°C do +60°C

wilgotność: <85% ciśnienie: 690-1060 hPa

CZ: teplota: od -25 ° C do + 60 ° C

vlhkost: <85% tlak: 690-1060 hPa

SK: teplota: od -25 ° C do + 60 ° C

vlhkost: <85% tlak: 690-1060 hPa

EN: temperature: from -25 ° C to + 60 ° C

humidity: <85% pressure: 690-1060 hPa

Uwagi / Komentář / Komentáre

PL: Zasilacz w komplecie

CZ: Napájení je součástí dodávky

SK: Napájanie je súčasťou dodávky

EN: Power supply included

Brolux

JUNO DALI



HIGH BAY LED ŚCIEMNIALNY DALI

CZ: Průmyslová svítidla LED HIGH BAY stmívatelné / SK: Priemyselná lampa stmievateľné / EN: LED high bay dimmable



Driver

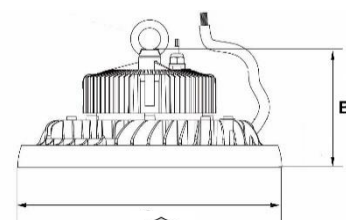
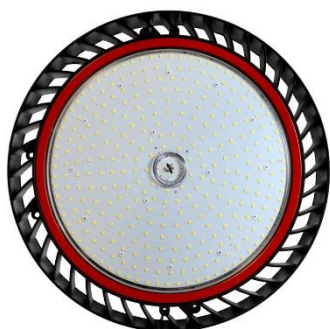

Średnia żywotność źródła światła L80B10 dla 70000h

INDEX	ABC				PF	Tc[K]		A [mm]	B [mm]	
012101	JUNO LED DALI	150W	23 250 lm	155lm/w	0.95	4000 K		360	187	5902216791060
012110	JUNO LED DALI	150W	23 250 lm	155lm/w	0.95	5700 K		360	180	5902216791503
012102	JUNO LED DALI	200W	30 000 lm	150lm/w	0.95	5700 K		360	187	5902216791077

AC 230V	SMD LED	120°	DALI
CRI/Ra	70000 h	IP 65	IK 10
IN&OUT			

Dostępne Akcesoria:



007115 Soczewka Lens 50°



010812 Soczewka Lens 90°



003745 Soczewka Lens 120°



006992 Soczewka Lens 150°



012130 Uchwyt do lampy LED high bay Juno I



012131 Uchwyt do lampy LED high bay Juno I

Materiał / Material / Material

PL: aluminium

CZ: hliník

SK: hliník

EN: aluminum

Optymalne warunki eksploatacji:

Optimální provozní podmínky:

Optimálne prevádzkové podmienky:

Optimal operating conditions:

PL: temperatura.: od -25°C do +60°C

wilgotność: <85% ciśnienie: 690-1060 hPa

CZ: teplota: od -25 ° C do + 60 ° C

vlhkost: <85% tlak: 690-1060 hPa

SK: teplota: od -25 ° C do + 60 ° C

vlhkost: <85% tlak: 690-1060 hPa

EN: temperature: from -25 ° C to + 60 ° C

humidity: <85% pressure: 690-1060 hPa

Uwagi / Komentář / Komentáre

PL: Zasilacz w komplecie

CZ: Napájení je součástí dodávky

SK: Napájanie je súčasťou dodávky

EN: Power supply included

Brolux

www.bowi.com.pl

JUNO PREMIUM



HIGH BAY LED ŚCIEMNIALNY 0-10V

CZ: Průmyslová svítidla LED HIGH BAY stmívatelné / SK: Priemyselná lampa stmievateľná / EN: LED high bay dimmable

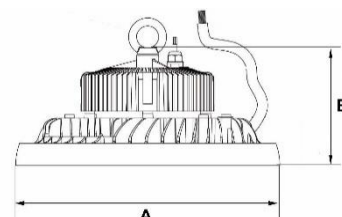
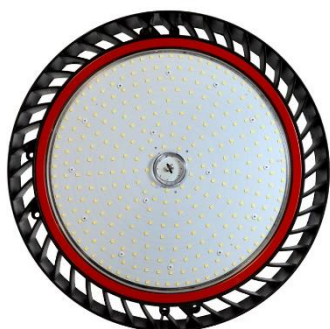

Średnia żywotność źródła światła L80B10 dla 70000h

INDEX	ABC				PF	Tc[K]		A [mm]	B [mm]	
012818	JUNO LED	100W	20 000 lm	200lm/W	0.95	5000 K	Czarny Černá Čierna Black	360	187	5902216797536

AC 230V	SMD LED	120°	0-10V
CRI(Ra) >80	70000 h	IP 65	IK 10
IN&OUT	CE	RoHS COMPLIANT	

Materiał / Materiál / Material

PL: aluminium

CZ: hliník

SK: hliník

EN: aluminum

Optymalne warunki eksploatacji:

Optimální provozní podmínky:

Optimálne prevádzkové podmienky:

Optimal operating conditions:

PL: temperatura: od -25°C do +60°C

wilgotność: <85% ciśnienie: 690-1060 hPa

CZ: teplota: od -25 °C do + 60 °C

vlhkost: <85% tlak: 690-1060 hPa

SK: teplota: od -25 °C do + 60 °C

vlhkosť: <85% tlak: 690-1060 hPa

EN: temperature: from -25 °C to + 60 °C

humidity: <85% pressure: 690-1060 hPa

Dostępne Akcesoria:



007115 Soczewka Lens 50°



010812 Soczewka Lens 90°



003745 Soczewka Lens 120°



006992 Soczewka Lens 150°



012130 Uchwył do lampy LED high bay Juno I



012131 Uchwył do lampy LED high bay Juno I

Uwagi / Komentář / Komentáre

PL: Zasilacz w komplecie

CZ: Napájení je součástí dodávky

SK: Napájanie je súčasťou dodávky

EN: Power supply included

Brolux

HIGH BAY LED ŚCIEMNIALNY 0-10V

CZ: Průmyslová svítidla LED HIGH BAY / SK: Priemyselná lampa / EN: LED high bay



NICHIA LED
Driver
PHILIPS

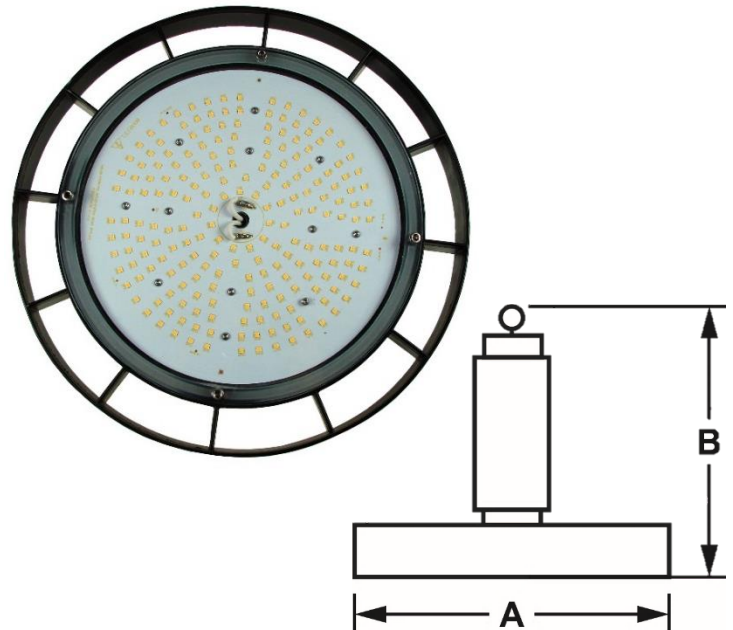

Średnia żywotność źródła światła L80B10 dla 70000h

INDEX	ABC				Tc[K]		A [mm]	B [mm]	
011975	Margo LED	100 W	13 000 lm	130 lm/W	4500 K	Czarny Černá Čierna Black	315	275	5902216791084
008796	Margo LED	100 W	13 000 lm	130 lm/W	5700 K		320	278	5902216725362
011976	Margo LED	150 W	19 500 lm	130 lm/W	4500 K		320	275	5902216791091
008797	Margo LED	150 W	19 500 lm	130 lm/W	5700 K		320	278	5902216725379
012299	Margo LED	200 W	26 000 lm	130 lm/W	4500 K		400	355	5902216793880
008798	Margo LED	200 W	26 000 lm	130 lm/W	5700 K		400	355	5902216725386

AC 230V	SMD LED	120°	0-10V
CRI(Ra) >80	PF 0,95	50000 h	
IN&OUT			

Uwagi / Komentář / Komentáre

PL: Zasilacz w komplecie

CZ: Napájení je součástí dodávky

SK: Napájanie je súčasťou dodávky

EN: Power supply included

Materiał / Materiál / Material

PL: aluminium

CZ: hliník

SK: hliník

EN: aluminum

Optymalne warunki eksploatacji:

Optimální provozní podmínky:

Optimálne prevádzkové podmienky:

Optimal operating conditions:

PL: temperatura.: od -25°C do +60°C

wilgotność: <85% ciśnienie: 690-1060 hPa

CZ: teplota: od -25°C do +60°C

vlhkost: <85% tlak: 690-1060 hPa

SK: teplota: od -25°C do +60°C

vlhkost: <85% tlak: 690-1060 hPa

EN: temperature: from -25°C to +60°C

humidity: <85% pressure: 690-1060 hPa

JERICO – AC LED



HIGH BAY LED

CZ: Průmyslová svítidla LED HIGH BAY / SK: Priemyselná lampa / EN: LED high bay

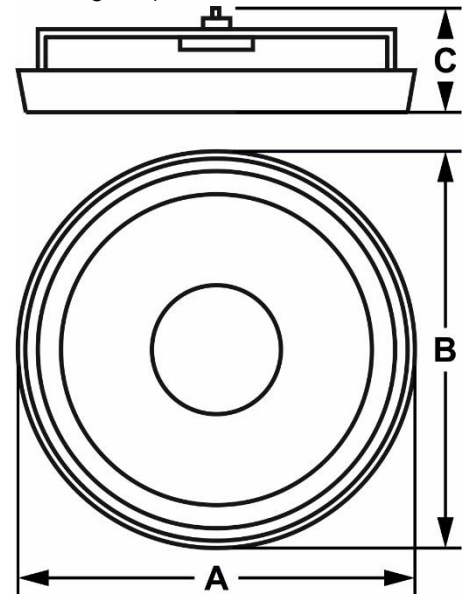
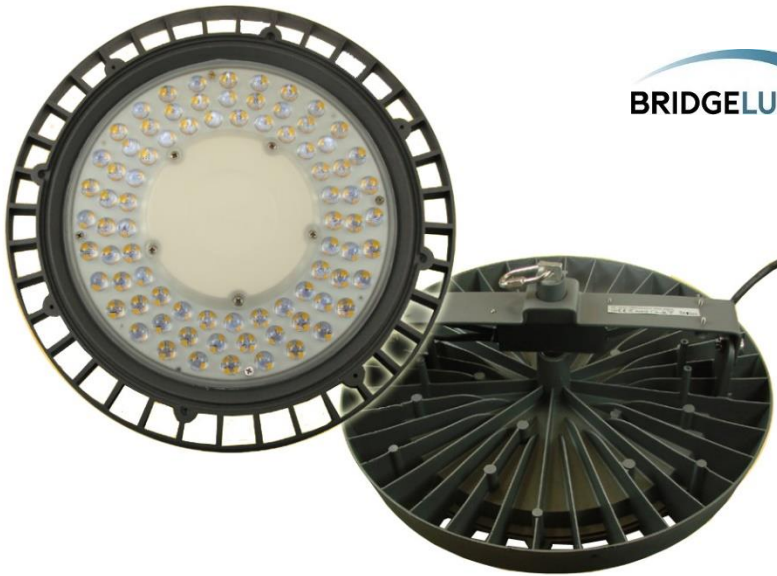

INDEX	ABC											A [mm]	B [mm]	C [mm]	
000272	JERICO LED	100 W	10 000 lm	100lm/W	60°	4500 K					Czarny	300	300	173	5902216725065
142	JERICO LED	150 W	15 000 lm	100lm/W	60°	4500 K					Černá	400	400	194	5902216725072
000314	JERICO LED	200 W	20 000 lm	100lm/W	60°	4500 K					Čierná Black	400	400	194	5902216725089

AC 230V	SMD LED	NON-DIM	IN&OUT
CRI/Ra	Lifespan	IP	PF
>70	50000 h	65	0,95
CE	RoHS COMPLIANT		

Materiał / Materiál / Material

PL: aluminium

CZ: hliník

SK: hliník

EN: aluminum

Optymalne warunki eksploatacji:

Optimální provozní podmínky:

Optimálne prevádzkové podmienky:

Optimal operating conditions:

PL: temperatura.: od -10°C do +25°C

wilgotność: <85% ciśnienie: 690-1060 hPa

CZ: teplota: od -10 ° C do + 25 ° C

vlhkost: <85% tlak: 690-1060 hPa

SK: teplota: od -10 ° C do + 25 ° C

vlhkost: <85% tlak: 690-1060 hPa

EN: temperature: from -10 ° C to + 25 ° C

humidity: <85% pressure: 690-1060 hPa

Uwagi / Komentář / Komentáre

PL: Zasilacz w komplecie

CZ: Napájení je součástí dodávky

SK: Napájanie je súčasťou dodávky

EN: Power supply included

BroLux

VELO



HIGH BAY LED

CZ: Průmyslová svítidla LED HIGH BAY / SK: Priemyselná lampa / EN: LED high bay



INDEX	ABC				PF	Tc[K]			A [mm]	B [mm]	C [mm]	
008808	VELO LED	100 W	100lm/W	110°	0,95	4500 K	Aluminium Hliník Hliník aluminum	Czarny Černá Čierná Black	280	280	80	5902216725249
008807	VELO LED	150 W	100lm/W	110°	0,95	4500 K			330	330	86	5902216725256
008820	VELO LED	200 W	100lm/W	110°	0,95	4500 K			370	370	88	5902216725263

AC 230V	IN&OUT	NON-DIM
CRi(Ra)	IP	
>80	50000 h	65
		SMD LED

Uwagi / Komentář / Komentáre

PL: Zasilacz w komplecie

CZ: Napájení je součástí dodávky

SK: Napájanie je súčasťou dodávky

EN: Power supply included

Optymalne warunki eksploatacji:

Optimální provozní podmínky:

Optimálne prevádzkové podmienky:

Optimal operating conditions:

PL: temperatura.: od -10°C do +40°C

wilgotność: <85% ciśnienie: 690-1060 hPa

CZ: teplota: od -10° C do + 40°C

vlhkost: <85% tlak: 690-1060 hPa

SK: teplota: od -10° C do +40°C

vlhkost: <85% tlak: 690-1060 hPa

EN: temperature: from -10°C to + 40°C

humidity: <85% pressure: 690-1060 hPa

Brolux

HIGH BAY LED

CZ: Průmyslová svítidla LED HIGH BAY / SK: Priemyselná lampa / EN: LED high bay



Driver

MW MODEL:
MEAN WELL **HBG**

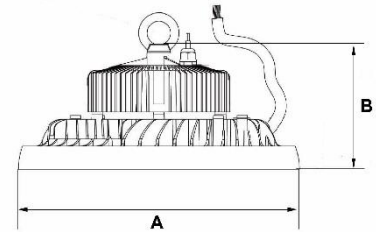

INDEX	ABC			PF	Tc[K]		A [mm]	B [mm]	
012258	HARLAND LED	100W	120 lm/w	>0,95	4000 K	Czarny Černá Čierná Black	360	147	5902216792715



AC 230V SMD LED 120°



>80 50000 h 65



Materiał / Materiál / Material

PL: aluminium

CZ: hliník

SK: hliník

EN: aluminium

Uwagi / Komentář / Komentáre

PL: Zasilacz w komplecie

CZ: Napájení je součástí dodávky

SK: Napájanie je súčasťou dodávky

EN: Power supply included

KARIF



HIGH BAY LED

CZ: Průmyslová svítidla LED HIGH BAY / SK: Priemyselná lampa / EN: LED high bay



OSRAM
LED

Driver
MW MODEL:
MEAN WELL

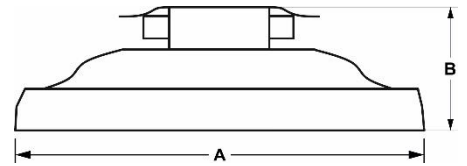

INDEX	ABC			PF	Tc[K]		A [mm]	B [mm]	
012259	KARIF LED	100W	120 lm/w	>0,95	5500 K	Czarny Černá Čierná Black	360	125	5902216792722



AC 230V SMD LED 120°



>80 50000 h 65



Materiał / Materiál / Material

PL: aluminium

CZ: hliník

SK: hliník

EN: aluminium

Uwagi / Komentář / Komentáre

PL: Zasilacz w komplecie

CZ: Napájení je součástí dodávky

SK: Napájanie je súčasťou dodávky

EN: Power supply included

BroLux

NELSON



HIGH BAY LED

CZ: Průmyslová svítidla LED HIGH BAY stmívatelné / SK: Priemyselná lampa stmievateľné / EN: LED high bay dimmable



Driver

MW MODEL:
MEAN WELL **HBG**

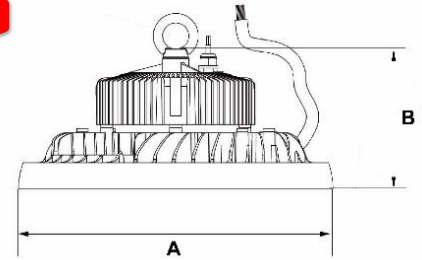

INDEX	ABC			PF	Tc[K]		A [mm]	B [mm]	
012260	NELSON LED	100W	120 lm/w	>0,95	5500 K	Czarny Černá Čierna Black	300	147	5902216792739

AC 230V	SMD LED	120°	
>80	50000 h	IP 65	

Materiał / Materiál / Material

PL: aluminium

CZ: hliník

SK: hliník

EN: aluminium

Uwagi / Komentář / Komentáre /

PL: Zasilacz w komplecie

CZ: Napájení je součástí dodávky

SK: Napájanie je súčasťou dodávky

EN: Power supply included

Br**o**lux

www.bowi.com.pl

RANGO



HIGH BAY LED

CZ: Průmyslová svítidla LED HIGH BAY / SK: Priemyselná lampa / EN: LED high bay

PHILIPS

LED



INDEX	ABC →				PF	Tc[K]		A [mm]	B [mm]	
013155	RANGO LED	100 W	18 000 lm	180lm/W	0.95	4000 K				5902808800293
013156	RANGO LED	120 W	21 600 lm	180lm/W	0.95	4000 K				5902808800309
013147	RANGO LED	150 W	27 000 lm	180lm/W	0.95	4000 K				5902808800217
013157	RANGO LED	180 W	32 400 lm	180lm/W	0.95	4000 K				5902808800316
013158	RANGO LED	200 W	36 000 lm	180lm/W	0.95	4000 K				5902808800323

Czarny
Černá
Čierna
Black

AC 230V	SMD LED	120°	IP
CRI(Ra) 70	70000 h	65	IN&OUT
RoHS COMPLIANT	CE	RoHS COMPLIANT	

Uwagi / Komentář / Komentáre

PL: Zasilacz w komplecie

CZ: Napájení je součástí dodávky

SK: Napájanie je súčasťou dodávky

EN: Power supply included

Materiał / Materiál / Material

PL: aluminium

CZ: hliník

SK: hliník

EN: aluminum

Optymalne warunki eksploatacji:

Optimální provozní podmínky:

Optimálne prevádzkové podmienky:

Optimal operating conditions:

PL: temperatura.: od -25°C do +60°C

wilgotność: <85% ciśnienie: 690-1060 hPa

CZ: teplota: od -25 ° C do + 60 ° C

vlhkost: <85% tlak: 690-1060 hPa

SK: teplota: od -25 ° C do + 60 ° C

vlhkost: <85% tlak: 690-1060 hPa

EN: temperature: from -25 ° C to + 60 ° C

humidity: <85% pressure: 690-1060 hPa

Brulux

FOSEN



HIGH BAY LED

CZ: Průmyslová svítidla LED HIGH BAY / SK: Priemyselná lampa / EN: LED high bay



INDEX	ABC				PF	Tc[K]		A [mm]	B [mm]	
013503	FOSEN LED	100 W	17 000 lm	170lm/W	0.95	4000 K	Czarny Černá Čierná Black	360	176	5902808803195
013504	FOSEN LED	150 W	25 500 lm	170lm/W	0.95	4000 K		360	176	5902808803201
013505	FOSEN LED	200 W	32 000 lm	160lm/W	0.95	4000 K		407	176	5902808803218

AC 230V	SMD LED	90°	
		IP	IK
70	70000 h	65	10
		CE	RoHS COMPLIANT
IN&OUT			

Uwagi / Komentář / Komentáre

PL: Zasilacz w komplecie

CZ: Napájení je součástí dodávky

SK: Napájanie je súčasťou dodávky

EN: Power supply included

Materiał / Material / Material

PL: aluminium

CZ: hliník

SK: hliník

EN: aluminum

Optymalne warunki eksploatacji:

Optimální provozní podmínky:

Optimálne prevádzkové podmienky:

Optimal operating conditions:

PL: temperatura.: od -25°C do +60°C

wilgotność: <85% ciśnienie: 690-1060 hPa

CZ: teplota: od -25 ° C do + 60 ° C

vlhkost: <85% tlak: 690-1060 hPa

SK: teplota: od -25 ° C do + 60 ° C

vlhkost: <85% tlak: 690-1060 hPa

EN: temperature: from -25 ° C to + 60 ° C

humidity: <85% pressure: 690-1060 hPa

www.bowi.com.pl

Brølux

RAZO

HIGH BAY LED

CZ: Průmyslová svítilna LED HIGH BAY / SK: Priemyselná lampa / EN: LED high bay

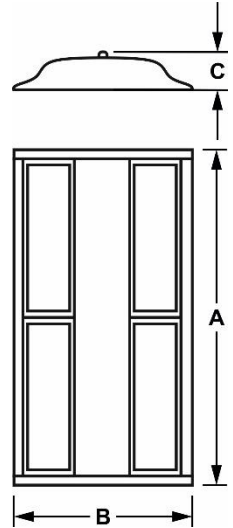

Średnia żywotność źródła światła L80B10 dla 70000h

		INDEX					Tc[K]		A [mm]	B [mm]	C [mm]	
A	012172	RAZO LED	100 W	14 000 lm	140lm/W	6000 K	Srebrny Sřiřbn sřiřbn silver		300	307	66	5902216791688
A	012168	RAZO LED	150 W	21 000 lm	140lm/W	6000 K			300	307	66	5902216791701
A	012244	RAZO LED	200 W	28 000 lm	140lm/W	4000 K			580	307	66	5902216792685
A	012173	RAZO LED	200 W	28 000 lm	140lm/W	5500 K			580	307	66	5902216791718
A	012170	RAZO LED	300 W	42 000 lm	140lm/W	5500 K			880	307	66	5902216791732
B	012171	RAZO LED	400 W	56 000 lm	140lm/W	5500 K			1155	307	66	5902216791749

		PF	
AC 230V	SMD LED	0,95	IN&OUT
		IP	
>70	50000 h	65	90°

Uwagi / Komentr / Komentre

PL: Zasilacz w komplecie

CZ: Napjen je soust dodvky

SK: Napjanie je suastou dodvky

EN: Power supply included

Materia / Materi / Materi

PL: aluminium

CZ: hlink

SK: hlink

EN: aluminum

Optymalne warunki eksploatacji:

Optimln provozn podmnky:

Optimln prevdzkov podmnky:

Optimal operating conditions:

PL: temperatura.: od -25°C do +60°C

wilgotnoc: <85% cinienie: 690-1060 hPa

CZ: teplota: od -25°C do +60°C

vlhkost: <85% tlak: 690-1060 hPa

SK: teplota: od -25°C do +60°C

vlhkost: <85% tlak: 690-1060 hPa

EN: temperature: from -25°C do +60°C

humidity: <85% pressure: 690-1060 hPa

BroLux

RAZO DALI



HIGH BAY LED ŚCIEMNIALNY DALI

CZ: Průmyslová svítidla LED HIGH BAY stmívatelné / SK: Priemyselná lampa stmievateľné / EN: LED high bay dimmable

PHILIPS
LED

DALI
DIMMABLE



Driver

MW MODEL:
MEAN WELL **ELG**



INDEX	ABC							A	B	C	
			Lm	Lm		[K]		[mm]	[mm]	[mm]	
012166	RAZO LED	100 W	14 000 lm	140lm/W	DALI	6000 K		300	307	66	5902216791695
012169	RAZO LED	200 W	28 000 lm	140lm/W	DALI	6000 K		580	307	66	5902216791725

AC 230V	SMD LED	120°	IN&OUT
CRI/Ra	50000 h	IP	PF
>70	50000 h	65	0,95
CE	RoHS COMPLIANT		

Uwagi / Komentář / Komentáre

PL: Zasilacz w komplecie

CZ: Napájení je součástí dodávky

SK: Napájanie je súčasťou dodávky

EN: Power supply included

Materiał / Material / Material

PL: aluminium

CZ: hliník

SK: hliník

EN: aluminum

Optymalne warunki eksploatacji:

Optimální provozní podmínky:

Optimálne prevádzkové podmienky:

Optimal operating conditions:

PL: temperatura: od -25°C do +60°C

wilgotność: <85% ciśnienie: 690-1060 hPa

CZ: teplota: od -25°C do +60°C

vlhkost: <85% tlak: 690-1060 hPa

SK: teplota: od -25°C do +60°C

vlhkost: <85% tlak: 690-1060 hPa

EN: temperature: from -25°C to +60°C

humidity: <85% pressure: 690-1060 hPa

BroLux

www.bowi.com.pl

MILAD – AC LED



HIGH BAY LED

CZ: Průmyslová svítidla LED HIGH BAY / SK: Priemyselna lampa / EN: LED high bay



A



B

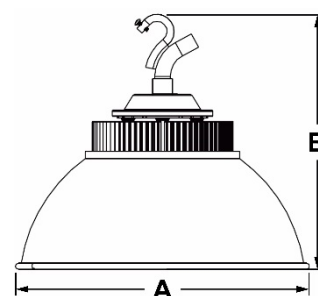

	INDEX	ABC			PF	Tc[K]		A [mm]	B [mm]	
A	004561	ACLED Milad	30 W	2500 lm	≥0.95	4500 K	Srebrny Sřiřbrnř střiřbrnř silver	335	262	5902216720862
A	483	ACLED Milad	55 W	4600 lm	≥0.95	4500 K		335	262	5902216720879
B	004562	ACLED Milad	100 W	9000 lm	≥0.95	4500 K		402	349	5902216720893
B	002051	ACLED Milad	100 W	9000 lm	≥0.95	5700 K		402	349	5902216720886
B	004564	ACLED Milad	150 W	13500 lm	≥0.95	4500 K		410	353	5902216720916
B	006287	ACLED Milad	150 W	13500 lm	≥0.95	5700 K		410	353	5902216720909
B	006814	ACLED Milad	200 W	20000 lm	≥0.95	5700 K		536	379	5902216732001

Materiał / Materiřl / Materiřl

PL: aluminium

CZ: hlinřk

SK: hlinřk

EN: aluminum

Optymalne warunki eksploatacji:

Optimřlnř provoznř podmřinky:

Optimřlně prevřdzkově podmřienky:

Optimal operating conditions:

PL: temperatura.: od -25°C do +60°C

wilgotnořć: <85% ciřnienie: 690-1060 hPa

CZ: teplota: od -25°C do +60°C

vřhkost: <85% třlak: 690-1060 hPa

SK: teplota: od -25°C do +60°C

vřhkost: <85% třlak: 690-1060 hPa

EN: temperature: from -25°C to +60°C

humidity: <85% pressure: 690-1060 hPa



AC 230V

SMDLED

60°

NON-DIM



70

40000 h

INDOOR



Brolux

www.bowi.com.pl

ALCOTT – AC LED



HIGH BAY LED

CZ: Průmyslová svítidla LED HIGH BAY / SK: Priemyselná lampa / EN: LED high bay

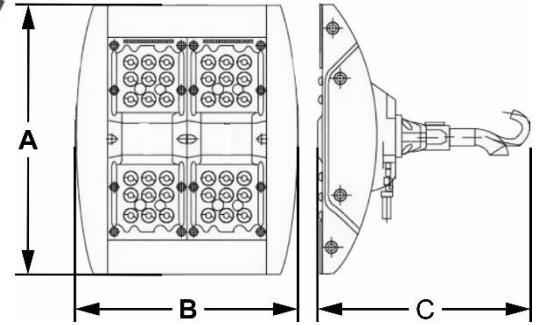

INDEX



Tc[K]



A [mm]

B [mm]

C [mm]



	INDEX	ABC	Power	lm	lm/W	Tc[K]		A [mm]	B [mm]	C [mm]	Barcode
A	010576	Alcott LED	60W	6 600 lm	110 lm/W	4500 K	Srebrny Stříbrná stříbrná silver	279	225	230	5902216710559
A	010562	Alcott LED	60W	6 600 lm	110 lm/W	5700 K		279	225	230	5902216719248
B	010574	Alcott LED	90W	9 900 lm	110 lm/W	5700 K		279	305	230	5902216710030
B	010608	Alcott LED	90W	9 900 lm	110 lm/W	4500 K		279	305	230	5902216719231
C	010616	Alcott LED	120W	13 200 lm	110 lm/W	4500 K		279	385	230	5902216710047
C	010529	Alcott LED	120W	13 200 lm	110 lm/W	5700 K		279	385	230	5902216701243
D	010617	Alcott LED	150W	16 500 lm	110lm/W	4500 K		279	465	230	5902216710054
D	008955	Alcott LED	150W	16 500 lm	110 lm/W	5700 K		279	465	230	5902216701236



AC 230V



Power LED



60°



NON-DIM



≥70



40000 h



65



IN&OUT



≥0.95



Materiał / Materiál / Material

PL: aluminium

CZ: hliník

SK: hliník

EN: aluminum

Optymalne warunki eksploatacji:

Optimální provozní podmínky:

Optimálne prevádzkové podmienky:

Optimal operating conditions:

PL: temperatura.: od -10°C do +25°C

wilgotność: <85% ciśnienie: 690-1060 hPa

CZ: teplota: od -10 ° C do + 25 ° C

vlhkost: <85% tlak: 690-1060 hPa

SK: teplota: od -10 ° C do + 25 ° C

vlhkost: <85% tlak: 690-1060 hPa

EN: temperature: from -10 ° C to + 25 ° C

humidity: <85% pressure: 690-1060 hPa

Brulux

HIGH BAY LED

CZ: Průmyslová svítidla LED HIGH BAY / SK: Priemyselná lampa / EN: LED high bay



A



B

	INDEX			W×H×D	
A	004974	Uchwył do lampy High Bay Alcott	Srebrny Sřiřbrn sřiřbrn silver	340x160mm	5902216710672
A	001115	Uchwył do lampy High Bay Alcott		420x160mm	5902216710689
B	366	Uchwył do lampy High Bay Alcott ruchomy		317x160mm	5902216713932
B	6657	Uchwył do lampy High Bay Alcott ruchomy		396x160mm	5902216713949



Materiał / Material / Material

PL: aluminium

CZ: hlink

SK: hlink

EN: aluminum

Lampy High Bay CREE



HIGH BAY LED

CZ: Průmyslová svítidla LED HIGH BAY / SK: Priemyselná lampa / EN: LED high bay



		INDEX						A [mm]	B [mm]	
A	010213	LED HIGH BAY	100 W	7500 lm	4500 K	Srebrny Sřiřbrn sřiřbrn silver		466,55	643,75	5902216726000
A	010214	LED HIGH BAY	100 W	7500 lm	6500 K			466,55	643,75	5902216725973
A	010215	LED HIGH BAY	150 W	11250 lm	4500 K			466,55	643,75	5902216725911
A	010216	LED HIGH BAY	150 W	11250 lm	6500 K			466,55	643,75	5902216726123
B	010218	LED HIGH BAY	200 W	15000 lm	6500 K	Szary řed řed Grey		379,7	158,5	5902216735750

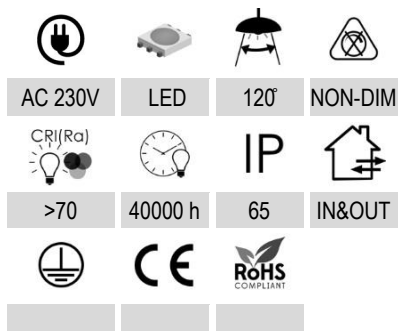

Materiał / Materiał / Materiał

PL: aluminium
 CZ: hlink
 SK: hlink
 EN: aluminum

Uwagi / Komentr / Komentre

PL: Zasilacz w komplecie
 CZ: Napjn je souast dodvky
 SK: Napjnie je suastou dodvky
 EN: Power supply included



HIGH BAY LED ŚCIEMIALNY 0-10V

CZ: Průmyslová svítidla LED HIGH BAY / SK: Priemyselna lampa / EN: LED high bay



Driver



MODEL:
HLG

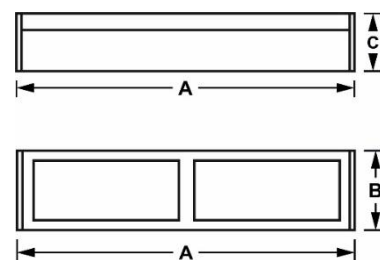

Średnia żywotność źródła światła L80B10 dla 70000h

	INDEX	ABC	⚡	💡 Lm	⚙️	💡 Lm	☂️	Tc[K]	🎯	A [mm]	B [mm]	C [mm]	📊
A	011806	SACHI LED	100W	12 200 lm	-	122lm/W	30x70°	5000 K	Czarny	600	141	79	5902216788244
B	011807	SACHI LED	150W	15 860 lm	0-10V	122lm/W	30x70°	5000 K	Černá Čierny Black	900	141	79	5902216788251

Dostępne akcesoria:

🔌	🔌	🏠	PF
AC 230V	SMD LED	IN&OUT	0.95
CRI(Ra)	🕒	IP	🌊
>80	50000 h	65	
CE	RoHS COMPLIANT		



011810 Soczewka Lens 80°



011809 Soczewka Lens 120°



012155 Uchwyt regulowany



012156 Uchwyt regulowany

Materiał / Material / Material

PL: aluminium

CZ: hliník

SK: hliník

EN: aluminum

Optymalne warunki eksploatacji:

Optimální provozní podmínky:

Optimálne prevádzkové podmienky:

Optimal operating conditions:

PL: temperatura.: od -25°C do +60°C

wilgotność: <85% ciśnienie: 690-1060 hPa

CZ: teplota: od -25°C do +60°C

vlhkost: <85% tlak: 690-1060 hPa

SK: teplota: od -25°C do +60°C

vlhkost: <85% tlak: 690-1060 hPa

EN: temperature: from -25°C to +60°C

humidity: <85% pressure: 690-1060 hPa

Uwagi / Komentář / Komentáre

PL: Zasilacz w komplecie

CZ: Napájení je součástí dodávky

SK: Napájanie je súčasťou dodávky

EN: Power supply included

SACHI DALI



HIGH BAY LED

CZ: Průmyslová svítidla LED HIGH BAY / SK: Priemyselná lampa / EN: LED high bay



Driver

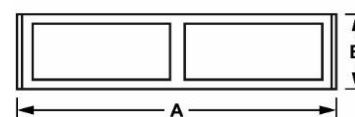
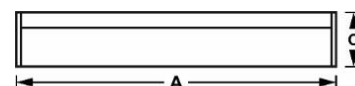

A

B

Średnia żywotność źródła światła L80B10 dla 70000h



	INDEX	ABC	Plug	Lm	Lm	Umbrella	Tc [K]	Mounting	A [mm]	B [mm]	C [mm]	Barcode
A	012117	SACHI LED	150W	15 860 lm	122lm/W	30x70°	5000 K	Czarny Černá Čierná Black	900	141	79	5902216791664
B	012118	SACHI LED	200W	26 000 lm	130lm/W	30x70°	5000 K		1200	141	79	5902216791671



AC 230V SMD LED IN&OUT DALI



>80 50000 h 65 0.95



Materiał / Materiál / Material

PL: aluminium

CZ: hliník

SK: hliník

EN: aluminum

Optymalne warunki eksploatacji:

Optimální provozní podmínky:

Optimálne prevádzkové podmienky:

Optimal operating conditions:

PL: temperatura.: od -25°C do +60°C

wilgotność: <85% ciśnienie: 690-1060 hPa

CZ: teplota: od -25°C do +60°C

vlhkost: <85% tlak: 690-1060 hPa

SK: teplota: od -25°C do +60°C

vlhkost: <85% tlak: 690-1060 hPa

EN: temperature: from -25°C do +60°C

humidity: <85% pressure: 690-1060 hPa

Dostępne akcesoria:



011810 Soczewk Lens 80°



011809 Soczewk Lens 120°



012155 Uchwyt regulowany

012156 Uchwyt regulowany

Uwagi / Komentář / Komentáre

PL: Zasilacz w komplecie

CZ: Napájení je součástí dodávky

SK: Napájanie je súčasťou dodávky

EN: Power supply included



SENTO



HIGH BAY LED

CZ: Průmyslová svítidla LED HIGH BAY / SK: Priemyselná lampa / EN: LED high bay



Driver

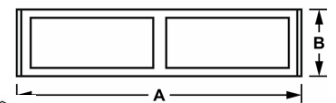
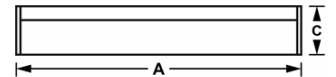

	INDEX	ABC					Tc[K]		A [mm]	B [mm]	C [mm]	
A	011804	SENTO LED	100 W	13 000 lm	130lm/W	30x70°	4000 K	Czarny Černá Čierná Black	600	141	79	5902216788220
B	011805	SENTO LED	150 W	18 000 lm	120lm/W	30x70°	4000 K		900	141	79	5902216788237
A	012066	SENTO LED	100 W	12 000 lm	120lm/W	30x70°	5500 K		600	141	79	5902216790995
B	012067	SENTO LED	150 W	18 000 lm	120lm/W	30x70°	5500 K		900	141	79	5902216791008

AC 230V	SMD LED	NON-DIM	IN&OUT
>80	50000 h	65	0,95

Dostępne akcesoria:



011810 Soczewk Lens 80°



011809 Soczewk Lens 120°



012155 Uchwyt regulowany



012156 Uchwyt regulowany

Materiał / Materiál / Material

PL: aluminium

CZ: hliník

SK: hliník

EN: aluminum

Optymalne warunki eksploatacji:

Optimální provozní podmínky:

Optimálne prevádzkové podmienky:

Optimal operating conditions:

PL: temperatura.: od -25°C do +60°C

wilgotność: <85% ciśnienie: 690-1060 hPa

CZ: teplota: od -25°C do +60°C

vlhkost: <85% tlak: 690-1060 hPa

SK: teplota: od -25°C do +60°C

vlhkost: <85% tlak: 690-1060 hPa

EN: temperature: from -25°C do +60°C

humidity: <85% pressure: 690-1060 hPa

Uwagi / Komentář / Komentáre

PL: Zasilacz w komplecie

CZ: Napájení je součástí dodávky

SK: Napájanie je súčasťou dodávky

EN: Power supply included

Brolux

ZAHRA



HIGH BAY LED

CZ: Průmyslová svítidla LED HIGH BAY / SK: Priemyselná lampa / EN: LED high bay



Driver

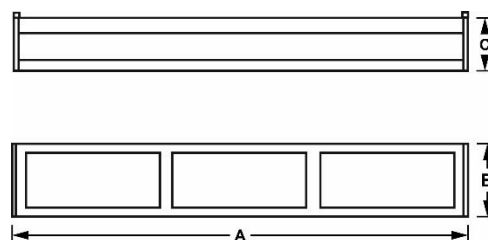

INDEX	ABC				PF	Tc[K]		A [mm]	B [mm]	C [mm]	
012246	ZAHRA LED	150 W	140 lm/W	30x70°	0,95	4000 K	Czarny Černá Čierna Black	900	141	114	5902216792630



AC 230V



SMD LED



IN&OUT



NON-DIM



70



50000 h



65



Materiał / Material / Material

PL: aluminium

CZ: hliník

SK: hliník

EN: aluminum

Uwagi / Komentář / Komentáře

PL: Zasilacz w komplecie

CZ: Napájení je součástí dodávky

SK: Napájanie je súčasťou dodávky

EN: Power supply included



XYLIA



HIGH BAY LED

CZ: Průmyslová svítidla LED HIGH BAY / SK: Priemyselná lampa / EN: LED high bay



Driver
MW MODEL:
MEAN WELL **ELG**

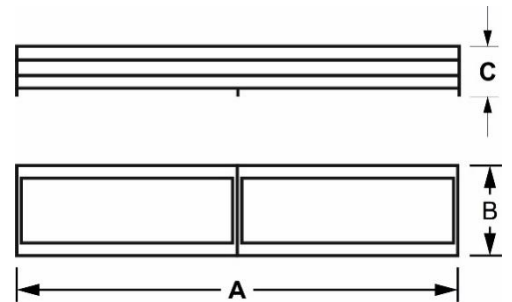

Średnia żywotność źródła światła L80B10 dla 70000h

INDEX	ABC				Tc[K]		A [mm]		B [mm]	C [mm]	
012208	XYLIA LED	150 W	21 000 lm	140 lm/W	6500 K	Czarny Černá Čierna Black	644	178	110	5902216792142	

AC 230V	SMD LED	60°	80
50000 h	IP 65	PF >0.95	

Uwagi / Komentář / Komentáre

PL: Zasilacz w komplecie

CZ: Napájení je součástí dodávky

SK: Napájanie je súčasťou dodávky

EN: Power supply included

Materiał / Materiál / Material

PL: aluminium

CZ: hliník

SK: hliník

EN: aluminum

Optymalne warunki eksploatacji:

Optimální provozní podmínky:

Optimálne prevádzkové podmienky:

Optimal operating conditions:

PL: temperatura.: od -25°C do +60°C

wilgotność: <85% ciśnienie: 690-1060 hPa

CZ: teplota: od -25°C do +60°C

vlhkost: <85% tlak: 690-1060 hPa

SK: teplota: od -25°C do +60°C

vlhkost: <85% tlak: 690-1060 hPa

EN: temperature: from -25°C do +60°C

humidity: <85% pressure: 690-1060 hPa



MORGAN



HIGH BAY LED

CZ: Průmyslová svítidla LED HIGH BAY / SK: Priemyselná lampa / EN: LED high bay

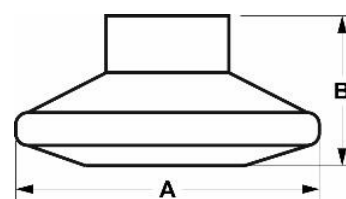

INDEX



PF



A
[mm]



B
[mm]



012350	MORGAN LED	200W	150 lm/W	>0,95	4000 K	Czarny Černá Čierna Black	386	190	5902216794542
--------	------------	------	----------	-------	--------	------------------------------------	-----	-----	---------------



AC 230V

SMD LED

120°



IP



80

50000 h

65



Materiał / Materiál / Material

PL: aluminium

CZ: hliník

SK: hliník

EN: aluminium

Uwagi / Komentář / Komentáre

PL: Zasilacz w komplecie

CZ: Napájení je součástí dodávky

SK: Napájanie je súčasťou dodávky

EN: Power supply included

Brolux

CALLUM



HIGH BAY LED

CZ: Průmyslová svítidla LED HIGH BAY / SK: Priemyselná lampa / EN: LED high bay

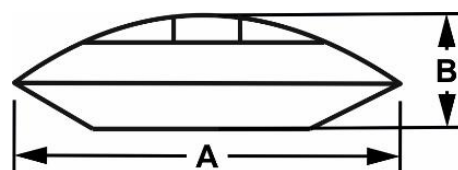

INDEX	ABC			PF	Tc[K]		A [mm]	B [mm]	
012351	CALLUM LED	200W	150 lm/W	>0,95	4000 K	Czarny Černá Čierna Black	420	200	5902216794559



AC 230V SMD LED 120°



80 50000 h 65



Materiał / Materiál / Material

PL: aluminium

CZ: hliník

SK: hliník

EN: aluminium

Uwagi / Komentář / Komentáře

PL: Zasilacz w komplecie

CZ: Napájení je součástí dodávky

SK: Napájanie je súčasťou dodávky

EN: Power supply included



www.bowi.com.pl

MALIK



HIGH BAY LED

CZ: Průmyslová svítidla LED HIGH BAY / SK: Priemyselná lampa / EN: LED high bay



Driver

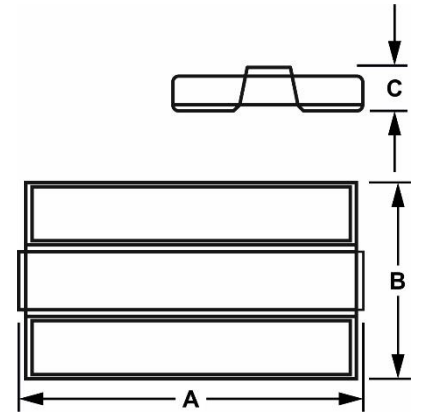

INDEX	ABC			PF	Tc[K]		A [mm]	B [mm]	C [mm]	
012353	MALIK LED	200W	150 lm/W	>0,95	5000 K	Czarny Černá Čierna Black	464	344	110	5902216794573



AC 230V SMD LED 60°



80 50000 h 65



Materiał / Materiał / Material

PL: aluminium

CZ: hliník

SK: hliník

EN: aluminium

Uwagi / Komentář / Komentáre

PL: Zasilacz w komplecie

CZ: Napájení je součástí dodávky

SK: Napájanie je súčasťou dodávky

EN: Power supply included



HIVE



HIGH BAY LED

CZ: Průmyslová svítidla LED HIGH BAY / SK: Priemyselná lampa / EN: LED high bay

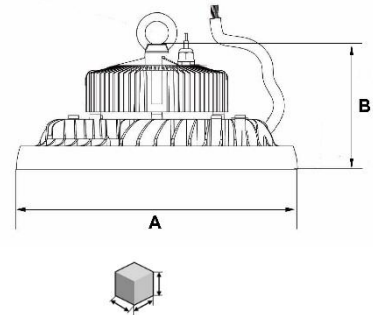
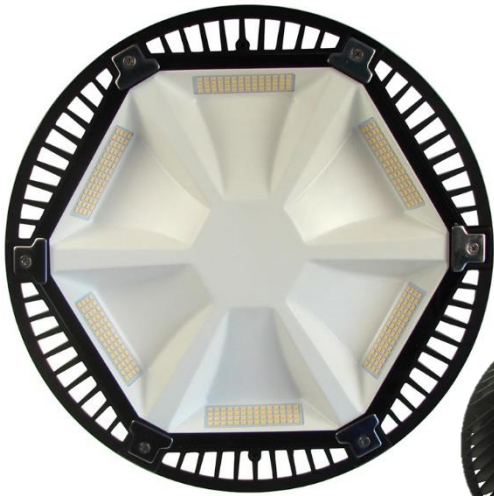

INDEX	ABC			PF	Tc[K]		A [mm]	B [mm]	
012444	HIVE LED	150W	160 lm/w	>0,90	4500 K	Czarny Černá Čierná Black	320	205	5902216794856

AC 230V	SMD LED	120°	
>80	50000 h	65	

Materiał / Materiál / Material

PL: aluminium

CZ: hliník

SK: hliník

EN: aluminium

Uwagi / Komentář / Komentáře

PL: Zasilacz w komplecie

CZ: Napájení je součástí dodávky

SK: Napájanie je súčasťou dodávky

EN: Power supply included



KOROS



HIGH BAY LED

CZ: Průmyslová svítidla LED HIGH BAY / SK: Priemyselná lampa / EN: LED high bay

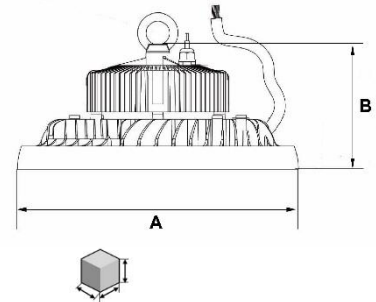
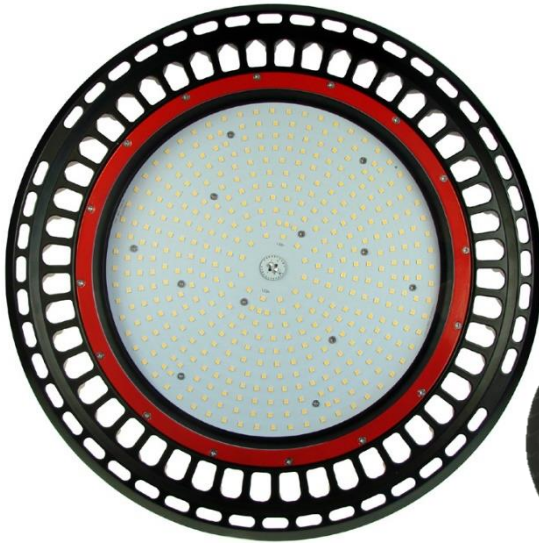

INDEX



PF



A
[mm]

B
[mm]



INDEX	ABC	Power	Light bulb	PF	Tc[K]	Color	A [mm]	B [mm]	Barcode
012445	KOROS LED	200W	150 lm/w	>0,90	4500 K	Czarny Černá Čierna Black	405	190	5902216794863



AC 230V

SMD LED

120°



IP



>80

50000 h

65



Materiał / Materiál / Material

PL: aluminium

CZ: hliník

SK: hliník

EN: aluminium

Uwagi / Komentář / Komentáre

PL: Zasilacz w komplecie

CZ: Napájení je součástí dodávky

SK: Napájanie je súčasťou dodávky

EN: Power supply included



MALLU



HIGH BAY LED

CZ: Průmyslová svítidla LED HIGH BAY / SK: Priemyselná lampa / EN: LED high bay

Driver

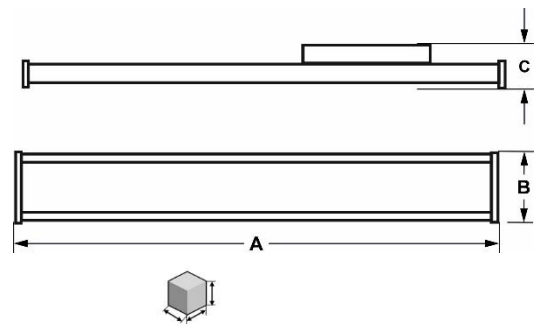
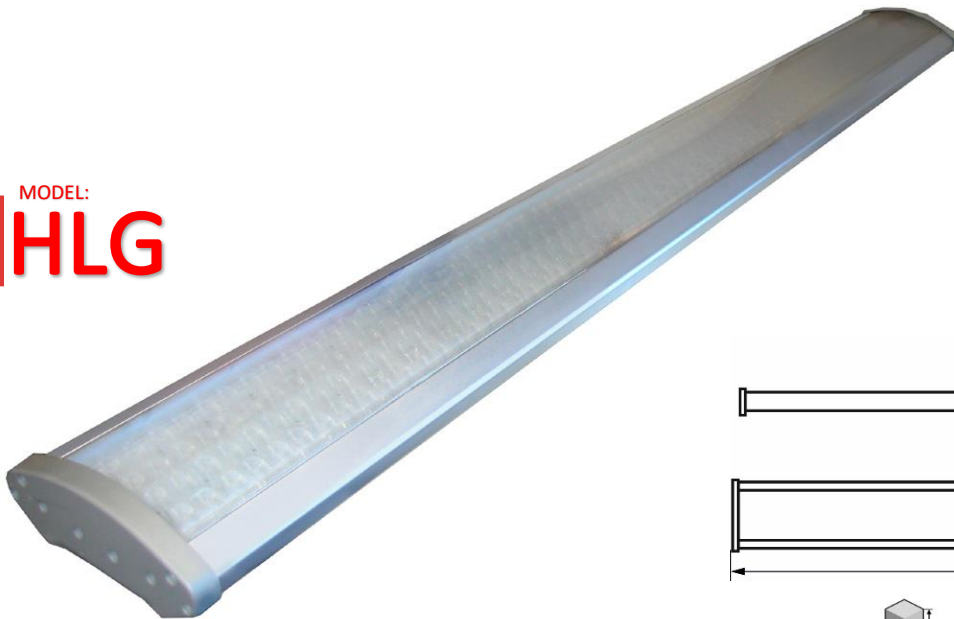

INDEX	ABC				PF	Tc[K]		A [mm]	B [mm]	C [mm]	
012446	MALLU LED	200W	120lm/w	120°	>0,9	4500 K	Srebrny Stříbrná stříbrná silver	1510	105	150	5902216794870

AC 230V	SMD LED	120°	
>80	50000 h	65	

Materiał / Material / Material

PL: aluminium

CZ: hliník

SK: hliník

EN: aluminum

Uwagi / Komentář / Komentáre

PL: Zasilacz w komplecie

CZ: Napájení je součástí dodávky

SK: Napájanie je súčasťou dodávky

EN: Power supply included

Br^olux

PAINE



HIGH BAY LED

CZ: Průmyslová svítidla LED HIGH BAY / SK: Priemyselná lampa / EN: LED high bay

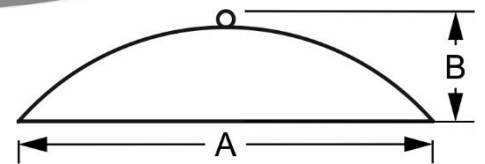

INDEX	ABC				PF	Tc[K]		A [mm]	B [mm]	
012893	PAINE LED	150W	18 000lm	120lm/W	>0,95	4500 K	Srebrny Stříbrná stříbrná silver	489	200	5902216798687

AC 230V	SMD LED	90	
80	50000 h		

Materiał / Materiál / Material

PL: aluminium

CZ: hliník

SK: hliník

EN: aluminum

Optymalne warunki eksploatacji:

Optimální provozní podmínky:

Optimálne prevádzkové podmienky:

Optimal operating conditions:

PL: temperatura.: od -25°C do +60°C

wilgotność: <85% ciśnienie: 690-1060 hPa

CZ: teplota: od -25°C do +60°C

vlhkost: <85% tlak: 690-1060 hPa

SK: teplota: od -25°C do +60°C

vlhkost: <85% tlak: 690-1060 hPa

EN: temperature: from -25°C do +60°C

humidity: <85% pressure: 690-1060 hPa

Uwagi / Komentář / Komentáre

PL: Zasilacz w komplecie

CZ: Napájení je součástí dodávky

SK: Napájanie je súčasťou dodávky

EN: Power supply included



DRACO



HIGH BAY LED

CZ: Průmyslová svítidla LED HIGH BAY / SK: Priemyselná lampa / EN: LED high bay



INVENTRONICS

LUMILEDS

INDEX	ABC		Lm	Lm	PF	Tc[K]		A [mm]	B [mm]	
006715	DRACO LED	150 W	28 500 lm	190 lm/W	0.95	4500 K		295	140	5902808804185
013633	DRACO LED	200 W	38 000 lm	190 lm/W	0.95	4500 K		320	154	5902808804192

AC 230V	SMD LED	90°	
CRI(Ra) >70	70000 h	IP 65	IN&OUT

Materiał / Materiál / Material

PL: aluminium

CZ: hliník

SK: hliník

EN: aluminum

Optymalne warunki eksploatacji:

Optimální provozní podmínky:

Optimálne prevádzkové podmienky:

Optimal operating conditions:

PL: temperatura.: od -25°C do +60°C

wilgotność: <85% ciśnienie: 690-1060 hPa

CZ: teplota: od -25 ° C do + 60 ° C

vlhkost: <85% tlak: 690-1060 hPa

SK: teplota: od -25 ° C do + 60 ° C

vlhkost: <85% tlak: 690-1060 hPa

EN: temperature: from -25 ° C to + 60 ° C

humidity: <85% pressure: 690-1060 hPa

Uwagi / Komentář / Komentáre

PL: Zasilacz w komplecie

CZ: Napájení je součástí dodávky

SK: Napájanie je súčasťou dodávky

EN: Power supply included

Brulux

www.bowi.com.pl

NAŚWIETLACZ DO OBIEKTÓW SPORTOWYCH

CZ: Světlořmety pro sportovní vyřití/ SK: Svetlořmety pre športové vyřitie/ EN: Illuminator for sports facilities

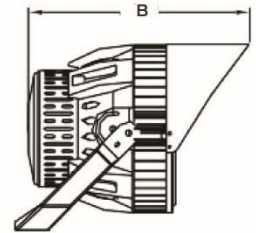
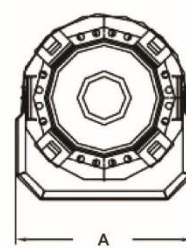

Driver



MODEL
HLG

INDEX	ABC				Tc[K]		A [mm]	B [mm]	
012516	Carly LED	480 W	62 400 lm	130 lm/W	5500 K	Czarny Černá Čierna Black	363	480	59022167960103



AC 230V



SMD LED



45°



1-10V



>70



40000 h



66



Materiał / Materiál / Material

PL: aluminium

CZ: hliník

SK: hliník

EN: aluminum

Optymalne warunki eksploatacji:

Optimální provozní podmínky:

Optimálne prevádzkové podmienky:

Optimal operating conditions:

PL: temperatura.: od -25°C do +60°C

wilgotność: <85% ciśnienie: 690-1060 hPa

CZ: teplota: od -25°C do +60°C

vlhkost: <85% tlak: 690-1060 hPa

SK: teplota: od -25°C do +60°C

vlhkost: <85% tlak: 690-1060 hPa

EN: temperature: from -25°C to +60°C

humidity: <85% pressure: 690-1060 hPa

Uwagi / Komentář / Komentáre

PL: Zasilacz w komplecie

CZ: Napájení je součástí dodávky

SK: Napájanie je súčasťou dodávky

EN: Power supply included

CANOPY



LAMPA LED DO STACJI PALIW

CZ: LED svítlna pro čerpací stanice / SK: LED lampa pre čerpacie stanice / EN: LED lamp for petrol stations



Driver



MODEL
HLG

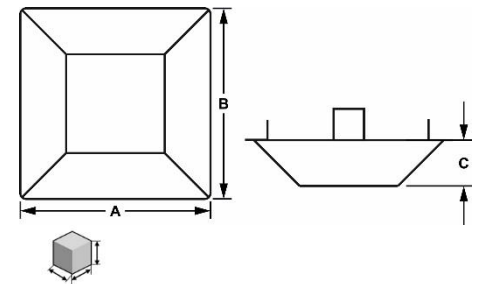

Średnia żywotność źródła światła L80B10 dla 70000h

INDEX	ABC				Tc[K]		A [mm]	B [mm]	C [mm]	
012499	Canopy LED	100 W	14 000 lm	140lm/W	4500 K	Biały biła bielá white	382	382	48,5	5902216795945
012500	Canopy LED	150 W	21 300 lm	142lm/W	4500 K		382	382	48,5	5902216795952

AC 230V	SMD LED	120°	1-10V
CRI/Ra	40000 h	IP	
>80	40000 h	65	
RoHS COMPLIANT	CE	RoHS COMPLIANT	

Uwagi / Komentář / Komentáre

PL: Zasilacz w komplecie

CZ: Napájení je součástí dodávky

SK: Napájanie je súčasťou dodávky

EN: Power supply included

Materiał / Materiál / Material

PL: aluminium

CZ: hliník

SK: hliník

EN: aluminum

Optymalne warunki eksploatacji:

Optimální provozní podmínky:

Optimálne prevádzkové podmienky:

Optimal operating conditions:

PL: temperatura.: od -25°C do +60°C

wilgotność: <85% ciśnienie: 690-1060 hPa

CZ: teplota: od -25°C do +60°C

vlhkost: <85% tlak: 690-1060 hPa

SK: teplota: od -25°C do +60°C

vlhkost: <85% tlak: 690-1060 hPa

EN: temperature: from -25°C to +60°C

humidity: <85% pressure: 690-1060 hPa

Brulux

ALCOTT - AC LED



LAMPA ULICZNA LED

CZ: LED pouliční lampa/ SK: LED pouličné lampy/ EN: LED street lamp



	INDEX	ABC	Power	Lm	PF	Tc[K]	Material	A [mm]	B [mm]	C [mm]	Barcode
A	010498	ALCOTT LED	60W	5100 lm	≥0.95	5700 K	Srebrny Sřiřbrná sřiřbrná silver	232	279	175	5902216719255
A	010552	ALCOTT LED	60W	5100 lm	≥0.95	4500 K		232	279	175	5902216710061
B	010509	ALCOTT LED	90W	9900 lm	≥0.95	5700 K		312	279	175	5902216713901
B	010535	ALCOTT LED	90W	9900 lm	≥0.95	4500 K		312	279	175	5902216719262
C	010514	ALCOTT LED	120W	13200 lm	≥0.95	5700 K		392	279	175	5902216710078
C	010534	ALCOTT LED	120W	13200 lm	≥0.95	4500 K		392	279	175	5902216710085
D	008966	ALCOTT LED	150W	16500 lm	≥0.95	5700 K		472	279	175	5902216713918
D	010530	ALCOTT LED	150W	16500 lm	≥0.95	4500 K		472	279	175	5902216713925

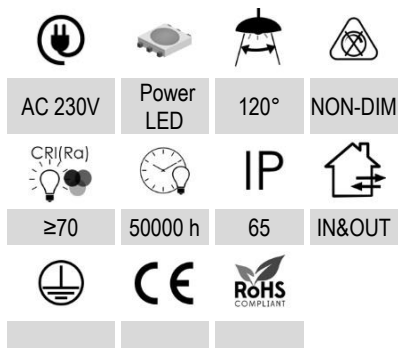

Materiał / Materiál / Material

PL: aluminium

CZ: hliník

SK: hliník

EN: aluminum

Optymalne warunki eksploatacji:

Optimální provozní podmínky:

Optimálne prevádzkové podmienky:

Optimal operating conditions:

PL: temperatura.: od -10°C do +25°C

wilgotność: <85% ciśnienie: 690-1060 hPa

CZ: teplota: od -10 ° C do + 25 ° C

vlhkost: <85% tlak: 690-1060 hPa

SK: teplota: od -10 ° C do + 25 ° C

vlhkosť: <85% tlak: 690-1060 hPa

EN: temperature: from -10 ° C to + 25 ° C

humidity: <85% pressure: 690-1060 hPa



MODUŁ LED



MODUŁ LED LAMPY ALCOTT

CZ: řízený modul / SK: vedený modul / EN: LED module

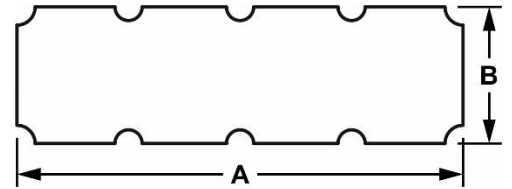
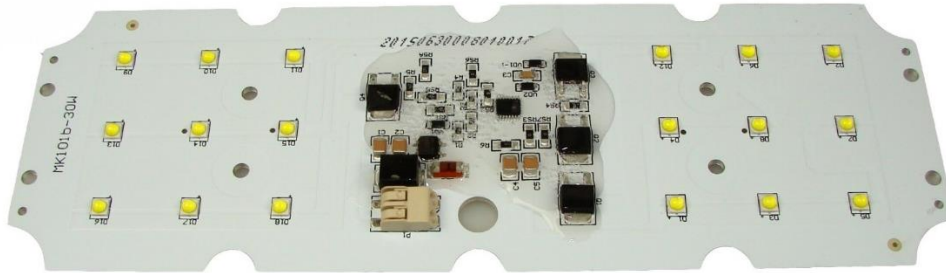

INDEX	ABC			Tc[K]	A [mm]	B [mm]	
000414	MODUŁ LED	30W	3300 lm	6500 K	197	60	5902216740969
000393	MODUŁ LED	30W	2550 lm	4500 K	197	60	5902216740952

AC 230V	Power LED	120°	NON-DIM
≥70	50000 h		

Materiał / Materiál / Materiál

PL: aluminium

CZ: hliník

SK: hliník

EN: aluminum



MACAWI - AC LED



LAMPA ULICZNA LED

CZ: LED pouliční lampa/ SK: LED pouličné lampy/ EN: LED street lamp

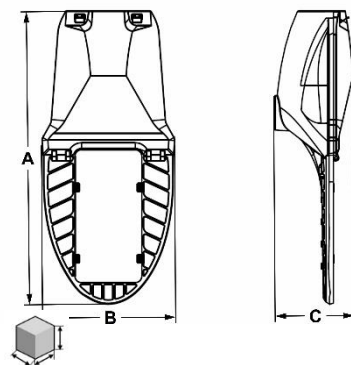
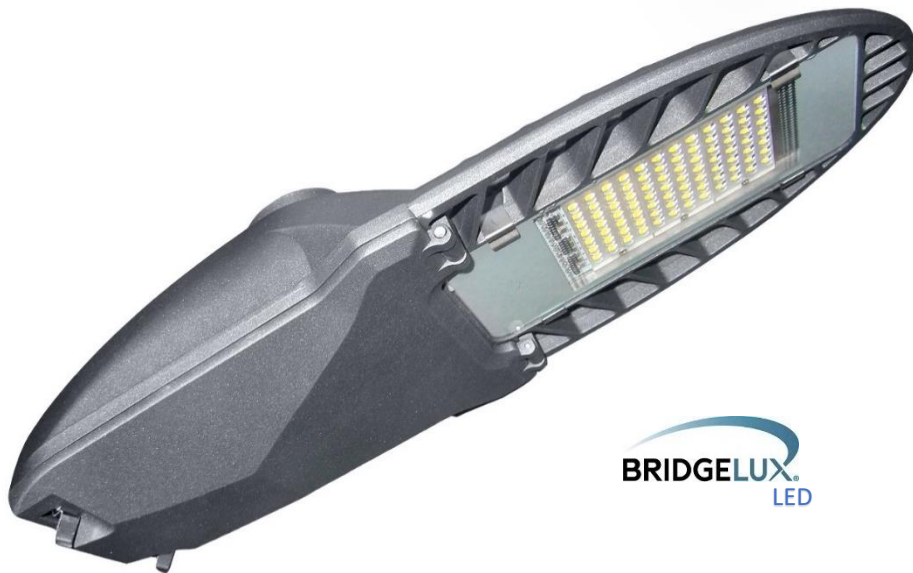

INDEX	ABC					PF	Tc[K]		A [mm]	B [mm]	C [mm]	
004557	ACLED Macawi	50W	6 000 lm	120 lm/W	≥0.95	4500 K	Szary Šedá Šedá Grey		535	242	140	5902216720831
004483	ACLED Macawi	75W	8 250lm	110 lm/W	≥0.95	4500 K			535	242	140	5902216720848
004486	ACLED Macawi	100W	11 000 lm	110 lm/W	≥0.95	4500 K			535	242	140	5902216720855
012114	ACLED Macawi	100W	11 000 lm	110 lm/W	≥0.95	6500 K			535	242	140	5902216791411

AC 230V	SMD LED	120°/60°	NON-DIM
70	50000 h	65	IN&OUT

Materiał / Materiál / Material

PL: aluminium

CZ: hliník

SK: hliník

EN: aluminum

Optymalne warunki eksploatacji:

Optimální provozní podmínky:

Optimálne prevádzkové podmienky:

Optimal operating conditions:

PL: temperatura.: od -10°C do +25°C

wilgotność: <85% ciśnienie: 690-1060 hPa

CZ: teplota: od -10 ° C do + 25 ° C

vlhkost: <85% tlak: 690-1060 hPa

SK: teplota: od -10 ° C do + 25 ° C

vlhkost: <85% tlak: 690-1060 hPa

EN: temperature: from -10 ° C to + 25 ° C

humidity: <85% pressure: 690-1060 hPa

MACAWI - AC LED



LAMPA ULICZNA LED

CZ: LED pouliční lampa/ SK: LED pouličné lampy/ EN: LED street lamp



BRIDGELUX
LED

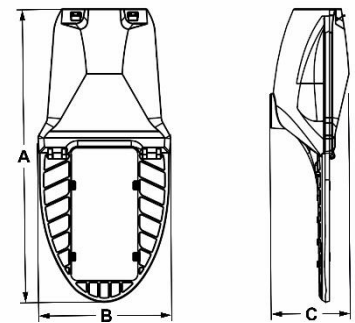

INDEX	ABC		Lm	Lm	PF	Tc[K]		A [mm]	B [mm]	C [mm]	
012391	ACLEd Macawi	50W	5 000lm	100 lm/W	≥0.95	4000 K	Szary Šedá Šedá Grey	420	195	115	5902216794825

AC 230V	SMD LED	140°x90°	NON-DIM
70	50000 h	65	IN&OUT

Materiał / Materiál / Material

PL: aluminium

CZ: hliník

SK: hliník

EN: aluminum

Optymalne warunki eksploatacji:

Optimální provozní podmínky:

Optimálne prevádzkové podmienky:

Optimal operating conditions:

PL: temperatura.: od -10°C do +25°C

wilgotność: <85% ciśnienie: 690-1060 hPa

CZ: teplota: od -10 ° C do + 25 ° C

vlhkost: <85% tlak: 690-1060 hPa

SK: teplota: od -10 ° C do + 25 ° C

vlhkost: <85% tlak: 690-1060 hPa

EN: temperature: from -10 ° C to + 25 ° C

humidity: <85% pressure: 690-1060 hPa

Br**o**lux

BREAD



LAMPA ULICZNA LED

CZ: LED pouliční lampa/ SK: LED pouličné lampy/ EN: LED street lamp



CREE
LEDs
Driver
MW
MEAN WELL



CREE
LEDs
Driver
MW
MEAN WELL



CREE
LEDs
Driver
MW
MEAN WELL

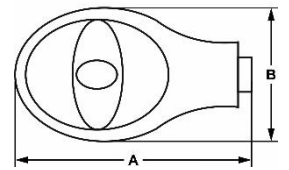

	INDEX	ABC			PF			Tc[K]		A [mm]	B [mm]	C [mm]	
A	009649	BREAD LED	30W	2250 lm	>0,90	LED	-	6500 K	Szary Šedá Šedá Grey	460	230	72	5902216788770
A	010220	BREAD LED	40W	2800 lm	>0,90	-	LED	6500 K		460	230	72	5902216716049
A	010219	BREAD LED	40W	3000 lm	>0,90	-	LED	4500 K		460	230	72	5902216702110
A	010516	BREAD LED	40W	3000 lm	>0,90	-	LED	3000 K		460	230	72	5902216702127
B	010517	BREAD LED	60W	3000 lm	>0,90	-	LED	3000 K		535	260	85	5902216716087
B	010221	BREAD LED	60W	4200 lm	>0,90	-	LED	6500 K		535	260	85	5902216702097
B	010222	BREAD LED	60W	4500 lm	>0,90	-	LED	4500 K		535	260	85	5902216702103
C	011694	BREAD LED	120W	9000 lm	>0,90	-	LED	4500 K		747	380	113	5902216702059
C	011695	BREAD LED	120W	9000 lm	>0,90	-	LED	6500 K		747	380	113	5902216702073
C	011696	BREAD LED	160W	12000 lm	>0,90	-	LED	4500 K		747	380	113	5902216702066
C	011697	BREAD LED	160W	12000 lm	>0,90	-	LED	6500 K		747	380	113	5902216702080



AC 230V



120° x 65°



NON-DIM



>70



50000 h



65



IN&OUT



ROHS COMPLIANT

Materiał / Materiál / Material

PL: aluminium

CZ: hliník

SK: hliník

EN: aluminum

Uwagi / Komentář / Komentáre

PL: Zasilacz w komplecie

CZ: Napájení je součástí dodávky

SK: Napájanie je súčasťou dodávky

EN: Power supply included

BREAD 24V



LAMPA ULICZNA LED

CZ: LED pouliční lampa/ SK: LED pouličné lampy/ EN: LED street lamp

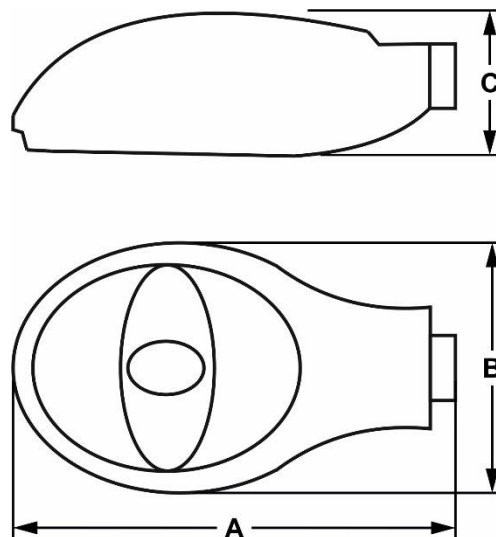

INDEX	ABC			PF	Tc[K]		A [mm]	B [mm]	C [mm]	
005663	BREAD LED	40W	2000 lm	>0,95	4500 K	Szary Šedá Šedá Grey	460	230	72	5902216788763

24V	LED	120° x 65°	NON-DIM
>70	50000 h	65	IN&OUT

Materiał / Materiál / Material

PL: aluminium

CZ: hliník

SK: hliník

EN: aluminum

Uwagi / Komentář / Komentáre

PL: Zasilacz w komplecie

CZ: Napájení je součástí dodávky

SK: Napájanie je súčasťou dodávky

EN: Power supply included



FARO



LAMPA ULICZNA LED

CZ: LED pouliční lampa/ SK: LED pouličné lampy/ EN: LED street lamp



CREE
LEDs

Driver
MW
MEAN WELL

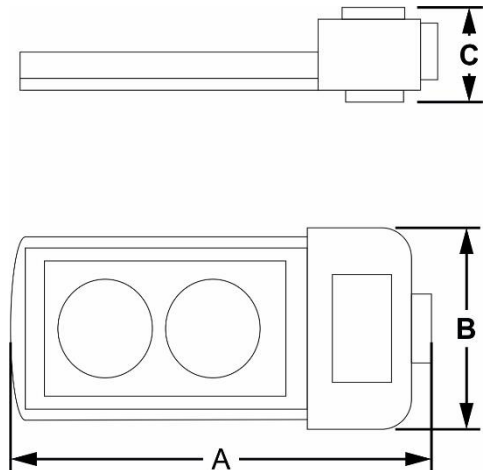

INDEX	ABC			PF	Tc[K]		A [mm]	B [mm]	C [mm]	
010518	FARO LED	40W	3000 lm	>0,95	3000 K	Szary Śedá Śedá Grey	543	222	99	5902216726178
010224	FARO LED	40W	3000 lm	>0,95	4500 K		543	222	99	5902216773646
010223	FARO LED	40W	3000 lm	>0,95	6500 K		543	222	99	5902216773653

AC 230V	LED	120° × 65°	NON-DIM
CRI(Ra) >70	50000 h	IP 65	IN&OUT
CE	RoHS COMPLIANT		

Materiał / Materiál / Material

PL: aluminium

CZ: hliník

SK: hliník

EN: aluminum

Uwagi / Komentář / Komentáre

PL: Zasilacz w komplecie

CZ: Napájení je součástí dodávky

SK: Napájanie je súčasťou dodávky

EN: Power supply included

Brolux

www.bowi.com.pl

TITAN



LAMPA ULICZNA LED

CZ: LED pouliční lampa/ SK: LED pouličné lampy/ EN: LED street lamp



Driver

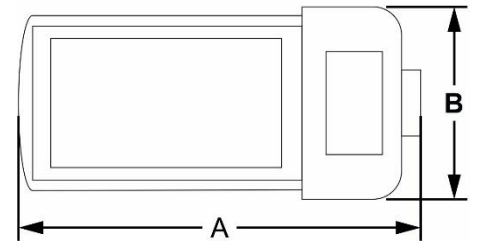
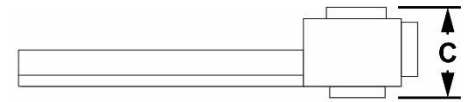

INDEX	ABC			PF	Tc[K]		A [mm]	B [mm]	C [mm]	
010519	TITAN LED	40W	3000 lm	>0,95	3000 K	Szary Šedá Šedá Grey	543	222	99	5902216716056
010226	TITAN LED	40W	3000 lm	>0,95	4500 K		543	222	99	5902216716063
010227	TITAN LED	40W	3000 lm	>0,95	6500 K		543	222	99	5902216716070

AC 230V	LED	120° x 65°	NON-DIM
>70	50000 h	65	IN&OUT

Materiał / Materiál / Material

PL: aluminium

CZ: hliník

SK: hliník

EN: aluminum

Uwagi / Komentář / Komentáre

PL: Zasilacz w komplecie

CZ: Napájení je součástí dodávky

SK: Napájanie je súčasťou dodávky

EN: Power supply included

Brolux

www.bowi.com.pl

LAMPA ULICZNA LED

CZ: LED pouliční lampa/ SK: LED pouličné lampy/ EN: LED street lamp

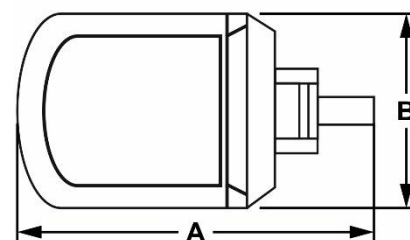

INDEX	ABC		Lm	PF	Tc[K]		A [mm]	B [mm]	C [mm]	
005579	SAER LED	30 W	2400 lm	>0,6	6500 K	Szary Šedá Šedá Grey	445	195	100	5902216717374
005657	SAER LED	30 W	2400 lm	>0,6	4500 K		445	195	100	5902216712140
005658	SAER LED	40 W	3200 lm	>0,6	6500 K		445	195	100	5902216706989
005662	SAER LED	40 W	3200 lm	>0,6	4500 K		445	195	100	5902216700314

AC 230V	Power LED	120°/65°	NON-DIM
>75	50000 h	65	IN&OUT

Materiał / Materiál / Material

PL: aluminium

CZ: hliník

SK: hliník

EN: aluminum

Uwagi / Komentář / Komentáre

PL: Zasilacz w komplecie

CZ: Napájení je součástí dodávky

SK: Napájanie je súčasťou dodávky

EN: Power supply included

LAMPA ULICZNA LED

CZ: LED pouliční lampa/ SK: LED pouličné lampy/ EN: LED street lamp

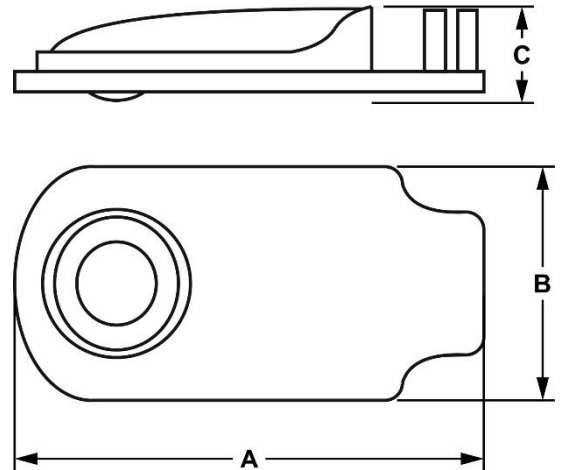

INDEX	ABC			PF	Tc[K]		A [mm]	B [mm]	C [mm]	
009908	LIMA LED	20 W	1200 lm	>0,6	4500 K	Szary Šedá Šedá Grey	360	180	60	5902216706934
009909	LIMA LED	20 W	1200 lm	>0,6	6500 K		360	180	60	5902216706941
009910	LIMA LED	30 W	1800 lm	>0,6	4500 K		360	180	60	5902216712133
009911	LIMA LED	30 W	1800 lm	>0,6	6500 K		360	180	60	5902216706958

AC 230V	COB	140x60°	NON-DIM
>75	50000 h	65	IN&OUT

Materiał / Materiál / Material

PL: aluminium

CZ: hliník

SK: hliník

EN: aluminum

Uwagi / Komentář / Komentáre

PL: Zasilacz w komplecie

CZ: Napájení je součástí dodávky

SK: Napájanie je súčasťou dodávky

EN: Power supply included

LAMPA ULICZNA LED

CZ: LED pouliční lampa/ SK: LED pouličné lampy/ EN: LED street lamp

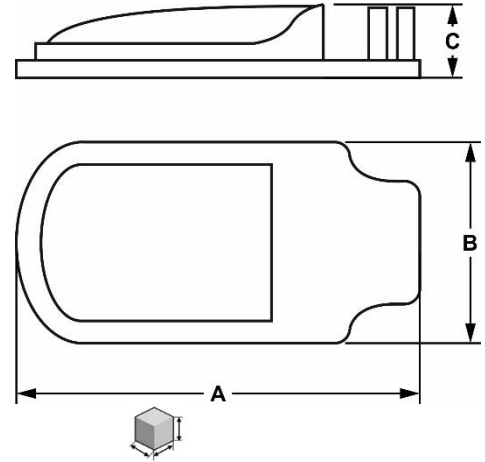

INDEX	ABC		Lm	PF	Tc[K]		A [mm]	B [mm]	C [mm]	
009019	FRAG LED	30 W	2400 lm	>0,6	4500 K	Szary Šedá Šedá Grey	480	200	42	5902216788787
009020	FRAG LED	30 W	2400 lm	>0,6	6500 K		480	200	42	5902216788794
009720	FRAG LED	50 W	4000 lm	>0,6	3000 K		570	240	42	5902216714250
009021	FRAG LED	50 W	4000 lm	>0,6	4500 K		570	240	42	5902216700253
009022	FRAG LED	50 W	4000 lm	>0,6	6500 K		570	240	42	5902216723801
009722	FRAG LED	60 W	4800 lm	>0,6	3000 K		570	240	42	5902216788800
009721	FRAG LED	60 W	4800 lm	>0,6	4500 K		570	240	42	5902216788817
009023	FRAG LED	60 W	4800 lm	>0,6	6500 K		570	240	42	5902216700260
009725	FRAG LED	100 W	8000 lm	>0,95	3000 K		590	280	80	5902216706927
009724	FRAG LED	100 W	8000 lm	>0,95	4500 K		590	280	80	5902216788824
009024	FRAG LED	100 W	8000 lm	>0,95	6500 K		590	280	80	5902216735781

AC 230V	Power LED	120°	NON-DIM
>75	50000 h	IP 65	IN&OUT

Materiał / Materiál / Material

PL: aluminium

CZ: hliník

SK: hliník

EN: aluminum

Uwagi / Komentář / Komentáre

PL: Zasilacz w komplecie

CZ: Napájení je součástí dodávky

SK: Napájanie je súčasťou dodávky

EN: Power supply included

LAMPA ULICZNA LED

CZ: LED pouliční lampa/ SK: LED pouličné lampy/ EN: LED street lamp



	INDEX	ABC			PF	Tc[K]		A [mm]	B [mm]	C [mm]		
A	009898	Mezzo LED	30 W	1800 lm	>0,6	4500 K	Szary Šedá Šedá Grey	550	280	120	5902216700284	
A	009899	Mezzo LED	30 W	1800 lm	>0,6	6500 K		550	280	120	5902216700291	
A	009901	Mezzo LED	40 W	2400 lm	>0,6	4500 K		550	280	120	5902216770188	
A	009900	Mezzo LED	40 W	2400 lm	>0,6	6500 K		550	280	120	5902216706965	
A	009903	Mezzo LED	50 W	3000 lm	>0,6	4500 K		550	280	120	5902216723795	
A	009902	Mezzo LED	50 W	3000 lm	>0,6	6500 K		550	280	120	5902216706972	
A	009917	Mezzo LED	60 W	3600 lm	>0,6	4500 K		550	280	120	5902216770171	
A	009904	Mezzo LED	60 W	3600 lm	>0,6	6500 K		550	280	120	5902216700307	
B	010874	Mezzo LED	100 W	6000 lm	>0,6	4500 K		620	310	90	5902216788831	
B	010873	Mezzo LED	100 W	6000 lm	>0,6	6500 K		620	310	90	5902216788848	
C	010875	Mezzo LED	200 W	12000 lm	>0,6	4500 K		620	310	90	5902216726246	
C	010876	Mezzo LED	200 W	12000 lm	>0,6	6500 K		620	310	90	5902216770164	

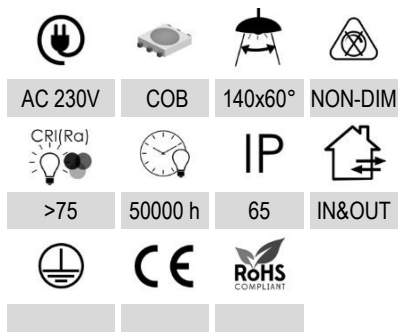

Materiał / Materiál / Material

PL: aluminium

CZ: hliník

SK: hliník

EN: aluminum

Uwagi / Komentář / Komentáre

PL: Zasilacz w komplecie

CZ: Napájení je součástí dodávky

SK: Napájanie je súčasťou dodávky

EN: Power supply included

LAMPA ULICZNA LED

CZ: LED pouliční lampa/ SK: LED pouličné lampy/ EN: LED street lamp



Driver



**REGULACJA KĄT
NACHYLENIA**

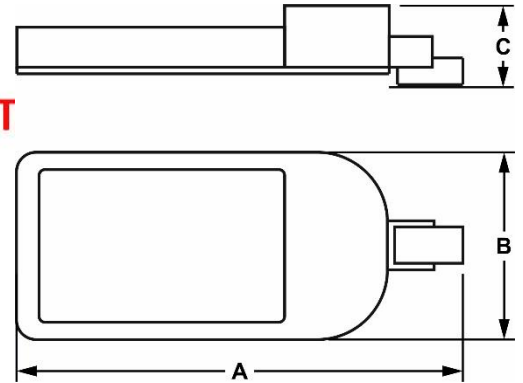

INDEX	ABC			PF	Tc[K]		A [mm]	B [mm]	C [mm]	
011519	PAGGA LED	60W	4800 lm	≥0.95	6500 K		850	350	175	5902216770157
011520	PAGGA LED	60W	4800 lm	≥0.95	4500 K		850	350	175	5902216726192
011513	PAGGA LED	100W	8000 lm	≥0.95	6500 K		850	350	175	5902216726277
011507	PAGGA LED	100W	8000 lm	≥0.95	4500 K		850	350	175	5902216788862
011521	PAGGA LED	150W	12000 lm	≥0.95	6500 K		950	400	175	5902216770140
011523	PAGGA LED	150W	12000 lm	≥0.95	4500 K		950	400	175	5902216788879

AC 230V	Power LED	120° × 65°	NON-DIM
		IP	
>75	50000 h	65	IN&OUT
	CE	RoHS COMPLIANT	

Materiał / Materiál / Material

PL: aluminium

CZ: hliník

SK: hliník

EN: aluminum

Uwagi / Komentář / Komentáre

PL: Zasilacz w komplecie

CZ: Napájení je součástí dodávky

SK: Napájanie je súčasťou dodávky

EN: Power supply included

WHEEL



LAMPA ULICZNA LED

CZ: LED pouliční lampa/ SK: LED pouličné lampy/ EN: LED street lamp



A



B

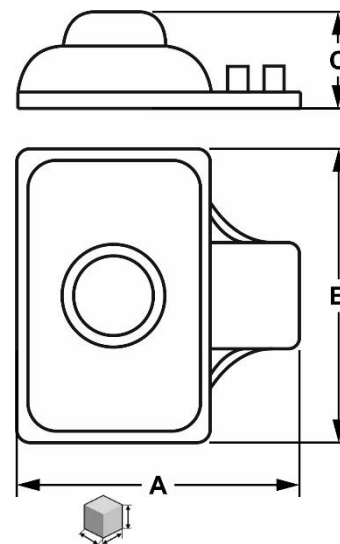

	INDEX	ABC			PF	Tc[K]		A [mm]	B [mm]	C [mm]	
A	009011	WHEEL LED	30 W	2100 lm	>0,6	3000 K	Szary Šedá Šedá Grey	300	250	115	5902216735811
A	009012	WHEEL LED	30 W	2100 lm	>0,6	4500 K		300	250	115	5902216735828
A	009013	WHEEL LED	30 W	2100 lm	>0,6	6500 K		300	250	115	5902216735835
A	009014	WHEEL LED	50 W	3500 lm	>0,6	3000 K		300	250	115	5902216735842
A	009016	WHEEL LED	50 W	3500 lm	>0,6	4500 K		300	250	115	5902216735859
A	009015	WHEEL LED	50 W	3500 lm	>0,6	6500 K		300	250	115	5902216735866
B	009726	WHEEL LED	100 W	7000 lm	>0,95	3000 K		520	235	115	5902216712157
B	009018	WHEEL LED	100 W	7000 lm	>0,95	4500 K		520	235	115	5902216712164
B	009017	WHEEL LED	100 W	7000 lm	>0,95	6500 K		520	235	115	5902216788855



AC 230V



COB



120°



NON-DIM



>75



50000 h



65



IN&OUT



Materiał / Materiál / Material

PL: aluminium

CZ: hliník

SK: hliník

EN: aluminum

Uwagi / Komentář / Komentáre

PL: Zasilacz w komplecie

CZ: Napájení je součástí dodávky

SK: Napájanie je súčasťou dodávky

EN: Power supply included

Brolux

LAMPA ULICZNA LED

CZ: LED pouliční lampa/ SK: LED pouličné lampy/ EN: LED street lamp



PHILIPS
LED
Driver
INVENTRONICS

ODGROMNIK 10kV
WYŁĄCZNIK ZASILANIA PO OTWARCIU OBUDOWY

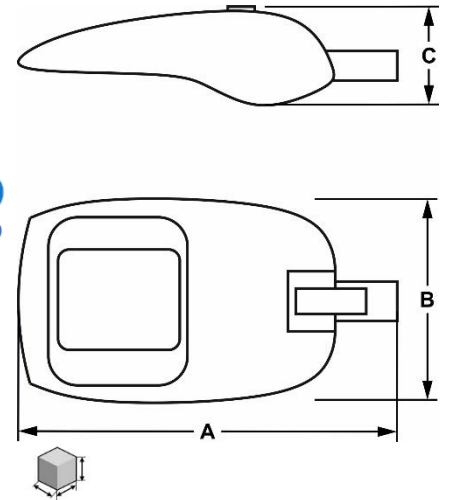

INDEX	ABC			PF	Tc[K]		A [mm]	B [mm]	C [mm]	
012107	ISSA LED	60W	150lm/W	0,97	4000 K	Szary Šedá Šedá Grey	530	260	105	5902216791138



AC 230V



SMD3030



120°

0-10V
dimmable

CRI>80



50000h



65



IN&OUT



Materiał / Materiál / Material

PL: aluminium

CZ: hliník

SK: hliník

EN: aluminum

Uwagi / Komentář / Komentáre

PL: Zasilacz w komplecie

CZ: Napájení je součástí dodávky

SK: Napájanie je súčasťou dodávky

EN: Power supply included





UCHWYTY



DO LAMP ULICZNYCH LED

CZ: LED pouliční lampa/ SK: LED pouličné lampy/ EN: LED street lamp



	INDEX			 W×H	
A	012132	Uchwyt regulowany do lampy ulicznej	Srebrny Sříbrná sříbrná silver	250×80 mm	5902216792326
B	012133	Uchwyt regulowany do lampy ulicznej		230×90 mm	5902216794818
C	012654	Uchwyt adapter lampy ulicznej 40/60mm		75×165 mm	5902216797062



Materiał / Materiál / Material

PL: aluminium

CZ: hliník

SK: hliník

EN: aluminum



GABOR



LAMPA ULICZNA LED

CZ: LED pouliční lampa/ SK: LED pouličné lampy/ EN: LED street lamp



INVENTRONICS

LUMILEDS

INDEX	ABC			PF	Tc[K]		A [mm]	B [mm]	C [mm]	
012237	GABOR LED	60 W	175 lm/W	>0,6	4000 K		683	260	130	5902216792463
010870	GABOR LED	120 W	175 lm/W	0,95	4000 K	Szary Šedá Šedá Grey	683	260	130	5902808807247
009725	GABOR LED	150 W	175 lm/W	0,95	4000 K		683	260	130	5902216706927

AC 230V	SMD	60x120°	NON-DIM
CRI/Ra	50000 h	IP	IN&OUT
>80	CE	RoHS COMPLIANT	

Materiał / Materiál / Material

PL: aluminium

CZ: hliník

SK: hliník

EN: aluminum

Uwagi / Komentář / Komentáre

PL: Zasilacz w komplecie

CZ: Napájení je součástí dodávky

SK: Napájanie je súčasťou dodávky

EN: Power supply included

Brulux

LAMPA PARKINGOWA ULICZNA LED

CZ: LED parkovací pouliční lampa/ SK: LED parkovaciepouličné lampy/ EN: LED parking street lamp



Driver
MW MEAN WELL MODEL:
HLG

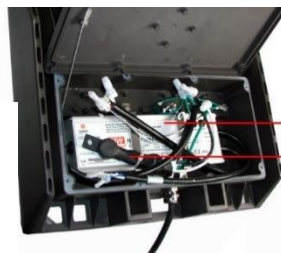

Zasilacz MeanWell HLG
 Ściemniak 0-10V



Ochrona przeciwprzepięciowa
PHILIPS 10kA
 Wydłuża życie lampy

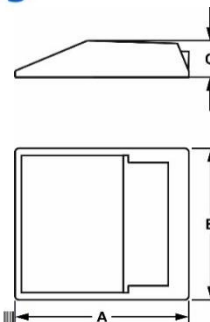

INDEX	ABC	⚡	💡 Lm	Tc [K]	📐	A [mm]	B [mm]	C [mm]	📊
012178	Bahira LED	60 W	7 200 lm	120 lm/W	4000 K	385	340	80	5902216791879
012179	Bahira LED	60 W	7 200 lm	120 lm/W	5700 K	385	340	80	5902216791886
012176	Bahira LED	100 W	12 000 lm	120 lm/W	4000 K	385	340	80	5902216791893
012177	Bahira LED	100 W	12 000 lm	120 lm/W	5700 K	385	340	80	5902216791909
012121	Bahira LED	150 W	18 000 lm	120 lm/W	4000 K	385	340	80	5902216791534
012175	Bahira LED	150 W	18 000 lm	120 lm/W	6500 K	385	340	80	5902216791923
012181	Bahira LED	200 W	24 000 lm	120 lm/W	4000 K	385	340	80	5902216791930
012180	Bahira LED	200 W	24 000 lm	120 lm/W	5700 K	385	340	80	5902216791947
012183	Bahira LED	300 W	36 000 lm	120 lm/W	5700 K	385	340	105	5902216791954

Dostępne akcesoria:

AC 230V	SMD3030	70x150°	0-10V	10
CRI>80	50000h	65	IN&OUT	≥0.93



012187 Uchwyt uchylny Short
 Ø60mm, Kąt regulacji: 180°



012188 Uchwyt naświetlaczowy Whort
 Kąt regulacji: 180°



012185 Odgromnik 15kA
 Inventronics



012186 Odgromnik 10kA
 Philips

Materiał / Materiál / Material

PL: aluminium

CZ: hliník

SK: hliník

EN: aluminum

Optymalne warunki eksploatacji:

Optimální provozní podmínky:

Optimálne prevádzkové podmienky:

Optimal operating conditions:

PL: temperatura.: od -25°C do +60°C

wilgotność: <85% ciśnienie: 690-1060 hPa

CZ: teplota: od -25°C do +60°C

vlhkost: <85% tlak: 690-1060 hPa

SK: teplota: od -25°C do +60°C

vlhkost: <85% tlak: 690-1060 hPa

EN: temperature: from -25°C to +60°C

humidity: <85% pressure: 690-1060 hPa

Uwagi / Komentář / Komentáre

PL: Zasilacz w komplecie

CZ: Napájení je součástí dodávky

SK: Napájanie je súčasťou dodávky

EN: Power supply included



BAHIRA DALI



LAMPA PARKINGOWA ULICZNA LED

CZ: LED parkovací pouliční lampa/ SK: LED parkovaciepouličné lampy/ EN: LED parking street lamp



Driver

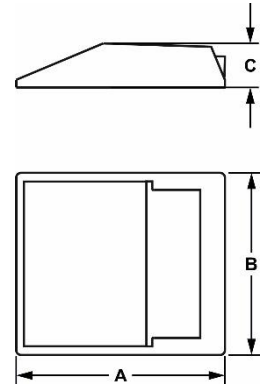

INDEX	ABC			PF	Tc[K]		A [mm]	B [mm]	C [mm]	
012182	Bahira LED	100 W	120 lm/W	≥0.93	5500 K	Szary Šedá Šedá Grey	385	340	80	5902216791916

Dostępne akcesoria:



012187 Uchwyt uchylny Short
Ø60mm, Kąt regulacji: 180°

012188 Uchwyt naświetlaczowy Whort
Kąt regulacji: 180°

012185 Odgromnik 10KV
Inventronics

012186 Odgromnik 20KV
Philips



AC 230V SMD3030 70x150° DALI



CRI>80 50000h 65 10



IN&OUT

Materiał / Materiál / Material

PL: aluminium

CZ: hliník

SK: hliník

EN: aluminum

Uwagi / Komentář / Komentáre

PL: Zasilacz w komplecie

CZ: Napájení je součástí dodávky

SK: Napájanie je súčasťou dodávky

EN: Power supply included

SABRA



LAMPA ULICZNA LED

CZ: LED parkovací pouliční lampa / SK: LED pakovacíepouličné lampy / EN: LED parking street lamp



Driver

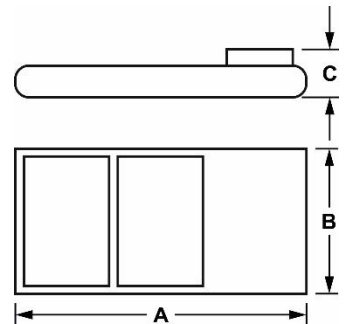

INDEX	ABC				PF	Tc[K]		A [mm]	B [mm]	C [mm]	
012581	SABRA LED	300 W	38 400 lm	128 lm/W	≥0.9	4000 K	Szary Šedá Šedá Grey	520	321	105	5902216796843

Dostępne akcesoria:

AC 230V	SMD3030	150°x65°	
80	50000h	66	IN&OUT



012608 Uchwyt do lampy ulicznej LED Sabra

Materiał / Materiál / Material

PL: aluminium

CZ: hliník

SK: hliník

EN: aluminum

Optymalne warunki eksploatacji:

Optimální provozní podmínky:

Optimálne prevádzkové podmienky:

Optimal operating conditions:

PL: temperatura.: od -25°C do +60°C

wilgotność: <85% ciśnienie: 690-1060 hPa

CZ: teplota: od -25°C do +60°C

vlhkost: <85% tlak: 690-1060 hPa

SK: teplota: od -25°C do +60°C

vlhkost: <85% tlak: 690-1060 hPa

EN: temperature: from -25°C to +60°C

humidity: <85% pressure: 690-1060 hPa

Uwagi / Komentář / Komentáre

PL: Zasilacz w komplecie

CZ: Napájení je součástí dodávky

SK: Napájanie je súčasťou dodávky

EN: Power supply included



LAMPA ULICZNA LED

CZ: LED pouliční lampa/ SK: LED pouličné lampy/ EN: LED street lamp



Model
ELG



B



C

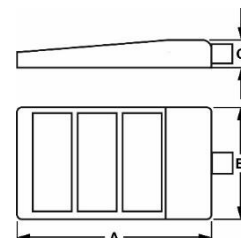

A

	INDEX	ABC	Power	Lm	Lm/W	PF	Tc[K]	Color	A [mm]	Height [mm]	C [mm]	Barcode
A	013712	LABID LED	150 W	19 500 lm	130lm/W	≥0.97	4500 K	Szary Šedá Šedá Grey	334	310	77	5902808805205
B	013885	LABID LED	200W	26 000 lm	130lm/W	>0,95	2700 K		455	310	77	5902808807490
B	013352	LABID LED	200W	26 000 lm	130lm/W	>0,95	4500 K		455	310	77	5902808801467
C	013884	LABID LED	300W	39 000 lm	130lm/W	≥0,97	2700 K		603	310	77	5902808807483
C	012592	LABID LED	300W	39 000 lm	130lm/W	≥0,97	4500 K		603	310	77	5902216796942

AC 230V	SMD3030	80°x150°	
>80	50000h	65	IN&OUT

Dostępne akcesoria:



012594 Uchwyt do lampy Jiabin, Labid I



012595 Uchwyt do lampy Jiabin, Labid II



012596 Uchwyt do lampy Jiabin, Labid III



012597 Uchwyt do lampy Jiabin, Labid IV

Średnica wewnętrzna 66 mm

Materiał / Materiál / Material

PL: aluminium

CZ: hliník

SK: hliník

EN: aluminum

Optymalne warunki eksploatacji:

Optimální provozní podmínky:

Optimálne prevádzkové podmienky:

Optimal operating conditions:

PL: temperatura.: od -25°C do +60°C

wilgotność: <85% ciśnienie: 690-1060 hPa

CZ: teplota: od -25°C do +60°C

vlhkost: <85% tlak: 690-1060 hPa

SK: teplota: od -25°C do +60°C

vlhkost: <85% tlak: 690-1060 hPa

EN: temperature: from -25°C to +60°C

humidity: <85% pressure: 690-1060 hPa

Uwagi / Komentář / Komentáre

PL: Zasilacz w komplecie

CZ: Napájení je součástí dodávky

SK: Napájanie je súčasťou dodávky

EN: Power supply included

JIABIN



LAMPA ULICZNA LED

CZ: LED pouliční lampa/ SK: LED pouličné lampy/ EN: LED street lamp

MW Model
MEAN WELL **ELG**



PHILIPS

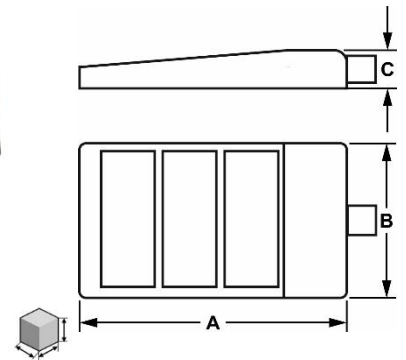

INDEX	ABC				PF	Tc[K]		A [mm]	B [mm]	C [mm]	
012591	JIABIN LED	300W	39 000 lm	130lm/W	≥0,97	4500 K		528	316	80	5902216796942

AC 230V	SMD3030	80°x150°	
>80	50000h	65	IN&OUT

Dostępne akcesoria:



012594 Uchwyt do lampy Jiabin, Labid I



012595 Uchwyt do lampy Jiabin, Labid II



012596 Uchwyt do lampy Jiabin, Labid III



012597 Uchwyt do lampy Jiabin, Labid IV

Materiał / Materiál / Material

PL: aluminium

CZ: hliník

SK: hliník

EN: aluminum

Optymalne warunki eksploatacji:

Optimální provozní podmínky:

Optimálne prevádzkové podmienky:

Optimal operating conditions:

PL: temperatura.: od -25°C do +60°C

wilgotność: <85% ciśnienie: 690-1060 hPa

CZ: teplota: od -25°C do +60°C

vlhkost: <85% tlak: 690-1060 hPa

SK: teplota: od -25°C do +60°C

vlhkost: <85% tlak: 690-1060 hPa

EN: temperature: from -25°C to +60°C

humidity: <85% pressure: 690-1060 hPa

Uwagi / Komentář / Komentáre

PL: Zasilacz w komplecie

CZ: Napájení je součástí dodávky

SK: Napájanie je súčasťou dodávky

EN: Power supply included

BroLux

LAMPA ULICZNA LED

CZ: LED pouliční svítidla / SK: pouličná lampa LED / EN: LED Street lamp



INDEX	ABC		Lm	PF	Tc [K]		A [mm]	B [mm]	C [mm]	
012038	BADER	100W	125lm/W	>0,90	4500K	Czarny Černá Čierna Black	470	321	94	5902216790445

AC 230V	SMD LED	60×150	1-10V
CRI(Ra)	40000 h	IP	IN&OUT
>80	CE	RoHS COMPLIANT	

Materiał / Materiál / Material

PL: aluminium

CZ: hliník

SK: hliník

EN: aluminum

Uwagi / Komentář / Komentáre

PL: Zasilacz w komplecie

CZ: Napájení je součástí dodávky

SK: Napájanie je súčasťou dodávky

EN: Power supply included

MABUZ



LAMPA ULICZNA LED

CZ: LED pouliční lampa/ SK: LED pouličné lampy/ EN: LED street lamp



Driver

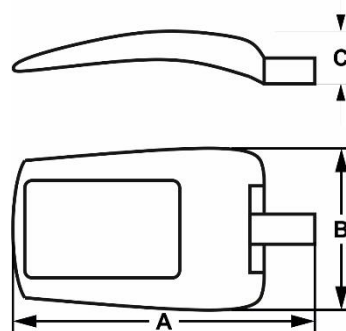

INDEX	ABC			PF	Tc[K]		A [mm]	B [mm]	C [mm]	
012108	Mabuz LED	120 W	138 lm/W	>0,95	4000 K	Szary Šedá Šedá Grey	690	300	170	5902216792142



AC 230V SMD LED 150°x75°



>80 50000h 65



Materiał / Materiál / Material

PL: aluminium

CZ: hliník

SK: hliník

EN: aluminum

Uwagi / Komentář / Komentáre

PL: Zasilacz w komplecie

CZ: Napájení je součástí dodávky

SK: Napájanie je súčasťou dodávky

EN: Power supply included



LAMPA ULICZNA LED

CZ: LED pouliční lampa/ SK: LED pouličné lampy/ EN: LED street lamp



Driver

LED



MODEL:

HLG

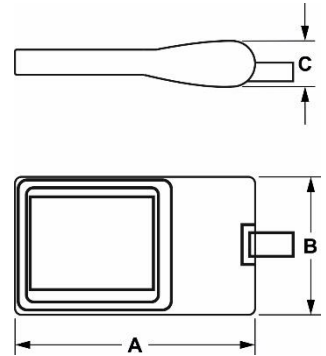

INDEX	ABC				PF	Tc[K]		A [mm]	B [mm]	C [mm]	
012908	RAND LED	30 W	3 900 lm	130 lm/W	0.95	4000 K	Szary Šedá Šedý Grey	550	200	125	5902808802617
011232	RAND LED	40 W	5 200 lm	130 lm/W	0.95	3000 K		550	200	125	5902216767157
012593	RAND LED	50 W	6 500 lm	130 lm/W	0.95	4000 K		550	200	125	5902216796874
012681	RAND LED	60 W	7 800 lm	130 lm/W	0.95	4000 K		550	200	125	5902216797376
012682	RAND LED	100 W	13 000 lm	130 lm/W	0.95	4000 K		625	235	125	5902216797383
012683	RAND LED	150 W	19 500 lm	130 lm/W	0.95	4000 K		685	260	125	5902216797390



AC 230V SMD3030 60x120°



>80 50000h 66 IN&OUT



68 mm

Uwagi / Komentář / Komentáre

PL: Zasilacz w komplecie

CZ: Napájení je součástí dodávky

SK: Napájanie je súčasťou dodávky

EN: Power supply included

Materiał / Materiál / Material

PL: aluminium

CZ: hliník

SK: hliník

EN: aluminum

Optymalne warunki eksploatacji:

Optimální provozní podmínky:

Optimálne prevádzkové podmienky:

Optimal operating conditions:

PL: temperatura.: od -25°C do +60°C

wilgotność: <85% ciśnienie: 690-1060 hPa

CZ: teplota: od -25°C do +60°C

vlhkost: <85% tlak: 690-1060 hPa

SK: teplota: od -25°C do +60°C

vlhkost: <85% tlak: 690-1060 hPa

EN: temperature: -25°C to +60°C

humidity: <85% pressure: 690-1060 hPa

GREEN



LAMPA ULICZNA LED z funkcją redukcji mocy

CZ: LED pouliční lampa/ SK: LED pouličné lampy/ EN: LED street lamp



Driver

LED

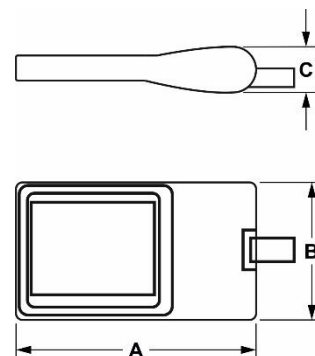

Power reduction

INDEX	ABC				PF	Tc[K]		A [mm]	B [mm]	C [mm]	
006699	GREEN LED	20 W	2 600 lm	130 lm/W	0.95	4500 K	Szary Šedá Šedá Grey	551	244	193	5902808800842
009276	GREEN LED	30 W	3 900 lm	130 lm/W	0.95	4500 K		551	244	193	5902808800859
006708	GREEN LED	40 W	5 200 lm	130 lm/W	0.95	4500 K		551	244	193	5902216712058
009277	GREEN LED	50 W	6 500 lm	130 lm/W	0.95	4500 K		551	244	193	5902808800866
006709	GREEN LED	60 W	7 800 lm	130 lm/W	0.95	4500 K		620	285	95	5902216712065
006710	GREEN LED	70 W	9 100 lm	130 lm/W	0.95	4500 K		551	244	193	5902216712072
006723	GREEN LED	80 W	10 400 lm	130 lm/W	0.95	4500 K		551	244	193	5902808800873
003561	GREEN LED	100 W	13 000 lm	130 lm/W	0.95	4500 K		745	285	95	5902216735774

AC 230V	SMD3030	60x120°	IP
>80	50000h	65	IN&OUT
68 mm			

Uwagi / Komentář / Komentáre

PL: Zasilacz w komplecie

CZ: Napájení je součástí dodávky

SK: Napájanie je súčasťou dodávky

EN: Power supply included

Materiál / Materiál / Material

PL: aluminium

CZ: hliník

SK: hliník

EN: aluminum

Optymalne warunki eksploatacji:

Optimální provozní podmínky:

Optimálne prevádzkové podmienky:

Optimal operating conditions:

PL: temperatura.: od -25°C do +60°C

wilgotność: <85% ciśnienie: 690-1060 hPa

CZ: teplota: od -25°C do +60°C

vlhkost: <85% tlak: 690-1060 hPa

SK: teplota: od -25°C do +60°C

vlhkost: <85% tlak: 690-1060 hPa

EN: temperature: from -25°C to +60°C

humidity: <85% pressure: 690-1060 hPa



CADOG AC LED

LAMPA ULICZNA LED

CZ: LED pouliční lampa/ SK: LED pouličné lampy/ EN: LED street lamp

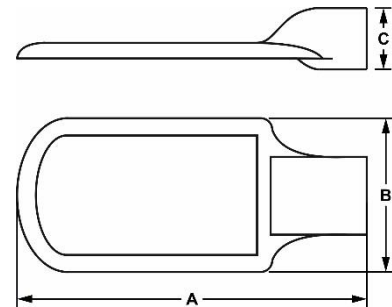

INDEX	ABC				Tc[K]		A [mm]	B [mm]	C [mm]	
011951	Cadog LED	30 W	3 000 lm	100lm/W	4000 K	Czarny Černá Čierná Black	303	130	70	5902216725393
011579	Cadog LED	50 W	5 000 lm	100lm/W	4000 K		395	168	88	5902216725416
011953	Cadog LED	70 W	7 000 lm	100lm/W	4000 K		395	168	88	5902216725409
011952	Cadog LED	100 W	10 000 lm	100lm/W	4000 K		460	220	88	5902216725394
007719	Cadog LED	150 W	15 000 lm	100lm/W	4000 K		460	220	88	5902216786875

			IP
AC 230V	SMD LED	110°	65
		PF	
70	40000 h	0,95	IN&OUT
	CE	RoHS COMPLIANT	

Uwagi / Komentář / Komentáre

PL: Zasilacz w komplecie

CZ: Napájení je součástí dodávky

SK: Napájanie je súčasťou dodávky

EN: Power supply included

Materiał / Materiál / Material

PL: aluminium

CZ: hliník

SK: hliník

EN: aluminum

Optymalne warunki eksploatacji:

Optimální provozní podmínky:

Optimálne prevádzkové podmienky:

Optimal operating conditions:

PL: temperatura.: od -10 ° C do + 40 ° C

wilgotność: <85% ciśnienie: 690-1060 hPa

CZ: teplota: od -10 ° C do + 40 ° C

vlhkost: <85% tlak: 690-1060 hPa

SK: teplota: od -10 ° C do + 40 ° C

vlhkost: <85% tlak: 690-1060 hPa

EN: temperature: from -10 ° C to + 40 ° C

humidity: <85% pressure: 690-1060 hPa

Brolux

LAMPA ULICZNA LED

CZ: LED pouliční lampa/ SK: LED pouličné lampy/ EN: LED street lamp

Driver

PHILIPS

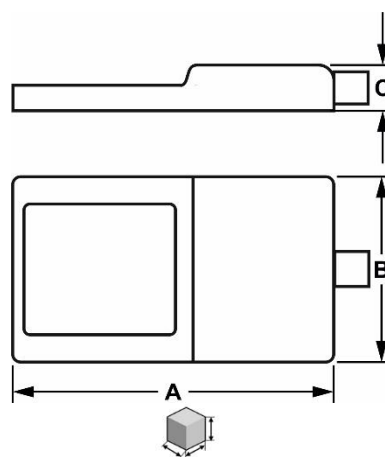

INDEX	ABC			PF	Tc[K]		A [mm]	B [mm]	C [mm]	
012237	GABOR LED	40 W	5050lm	>0,95	4000K	Szary Šedá Šedá Grey	520	330	70	5902216792463



AC 230V

120°



IP



>70

50000h

66



Materiał / Materiál / Material

PL: aluminium

CZ: hliník

SK: hliník

EN: aluminum

Uwagi / Komentár / Komentáre

PL: Zasilacz w komplecie

CZ: Napájení je součástí dodávky

SK: Napájanie je súčasťou dodávky

EN: Power supply included

LAMPA ULICZNA LED

CZ: LED pouliční lampa/ SK: LED pouličné lampy/ EN: LED street lamp



LED

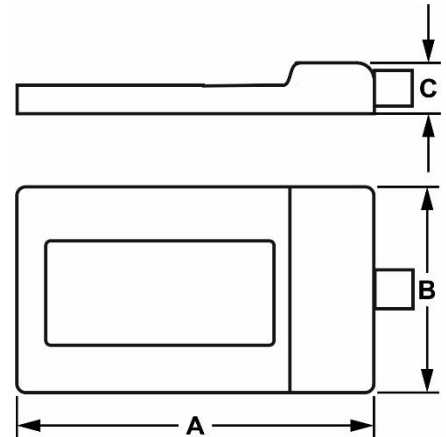

INDEX	ABC						IP					PF	Tc[K]		A [mm]	B [mm]	C [mm]	
012557	ABLAR LED	30W	4 500 lm	150lm/W	>0,95	4000K	Szary Šedá Šedá Grey	362	170	58	5902216796430							

AC 230V	SMD	70*120°	
		IP	
>70	50000h	65	

Dostępne akcesoria:



012564 Uchwyt adapter lampy ulicznej 40/60mm

Materiał / Materiál / Material

PL: aluminium

CZ: hliník

SK: hliník

EN: aluminum

Optymalne warunki eksploatacji:

Optimální provozní podmínky:

Optimálne prevádzkové podmienky:

Optimal operating conditions:

PL: temperatura.: od -25°C do +60°C

wilgotność: <85% ciśnienie: 690-1060 hPa

CZ: teplota: od -25°C do +60°C

vlhkost: <85% tlak: 690-1060 hPa

SK: teplota: od -25°C do +60°C

vlhkost: <85% tlak: 690-1060 hPa

EN: temperature: from -25°C to +60°C

humidity: <85% pressure: 690-1060 hPa

Uwagi / Komentář / Komentáre

PL: Zasilacz w komplecie

CZ: Napájení je součástí dodávky

SK: Napájanie je súčasťou dodávky

EN: Power supply included

KARDAM

LAMPA ULICZNA LED

CZ: LED pouliční lampa/ SK: LED pouličné lampy/ EN: LED street lamp



MODEL:
XLG

INDEX	ABC		Lm	Lm	PF	Tc[K]		A [mm]	B [mm]	C [mm]	
013801	KARDAM LED	200W	34 000 lm	170lm/W	>0,97	4000K		540	370	76	5902808806431

AC 230V	SMD	70*150°	
CRI(Ra)	>70	50000h	65

Uwagi / Komentář / Komentáre

PL: Zasilacz w komplecie

CZ: Napájení je součástí dodávky

SK: Napájanie je súčasťou dodávky

EN: Power supply included

Materiał / Materiál / Material

PL: aluminium

CZ: hliník

SK: hliník

EN: aluminum

Optymalne warunki eksploatacji:

Optimální provozní podmínky:

Optimálne prevádzkové podmienky:

Optimal operating conditions:

PL: temperatura.: od -25°C do +60°C

wilgotność: <85% ciśnienie: 690-1060 hPa

CZ: teplota: od -25°C do +60°C

vlhkost: <85% tlak: 690-1060 hPa

SK: teplota: od -25°C do +60°C

vlhkost: <85% tlak: 690-1060 hPa

EN: temperature: from -25°C to +60°C

humidity: <85% pressure: 690-1060 hPa

LAMPY PARKOWE LED



LAMPY PARKOWE LED Z MASZTEM

CZ: park LED lampy/ SK: park LED žiarovky/ EN: park LED lamps



	INDEX	ABC			PF	Tc[K]		Wysokość stupa [m]	
A	000593	Robb	30W	2399 lm	0,95	4500 K	Szary Šedá Šedá Grey	3m	5902216749139
B	001881	Roddy	30W	1850 lm	0,95	4500 K		3m	5902216774155
C	001896	Trevor	60W	5400 lm	0,95	4500 K		3m	5902216774162
D	001897	Vedell	30W	1800 lm	0,95	4500 K		3m	5902216749146
E	001899	Wilber	30W	1900 lm	0,95	4500 K		3m	5902216774179
F	003177	Wildon	35W	2698 lm	0,95	4500 K		3m	5902216774186
G	003464	Zeke	80W	7200 lm	0,95	4500 K		3m	5902216774193

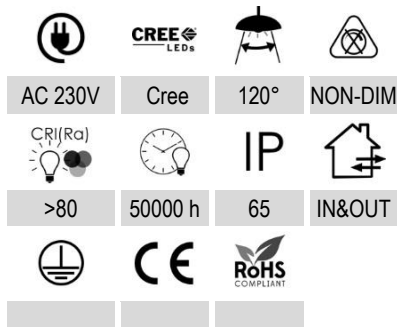

Materiał / Materiál / Material

PL: aluminium

CZ: hliník

SK: hliník

EN: aluminum

Uwagi / Komentář / Komentáre

PL: Zasilacz w komplecie

CZ: Napájení je součástí dodávky

SK: Napájanie je súčasťou dodávky

EN: Power supply included

Brolux

LAMPY PARKOWE LED



LAMPY PARKOWE LED

CZ: park LED lampy/ SK: park LED žiarovky/ EN: park LED lamps



	INDEX	ABC										
A	004479	Cingen	40W	3600 lm	0,95	4500 K	135°85°	Czarny Černá Čierná Black	562*562*210mm	5902216774308		
B	009686	Fareed	60W	4800 lm	0,95	4500 K	135°85°		562*562*210mm	5902216774346		
C	003187	Gillam	50W	4000 lm	0,95	4500 K	120°		565*565*400mm	5902216774353		
D	007952	Octavio	50W	3500 lm	0,95	4500 K	120°		605*605*425mm	5902216774360		
E	001179	Conhail	40W	3837 lm	0,95	5000 K	120°		Ø480x685mm	5902216774339		
F	001176	Colton	50W	4796 lm	0,95	5000 K	150°		Ø485x240 mm	5902216774322		
G	004549	Bivadi	40W	3837 lm	0,95	5000 K	120°		443x443x870mm	5902216774292		
H	9148	Collyer	40W	3837 lm	0,95	5000 K	150°		Ø560x400mm	5902216774315		
I	012890	Willie	40W	2450 lm	0,9	4000 K	360°	Ø520x480 mm	5902216798601			
J	012887	Lacy	40W	3586 lm	0,9	4000 K	360°	Ø450x320 mm	5902216798571			
K	012888	Makala	30W	1922 lm	0,9	4000 K	360°	Ø450x370 mm	5902216798588			
L	012889	Weslia	30W	3814 lm	0,9	4000 K	360°	Ø450x440 mm	5902216798595			

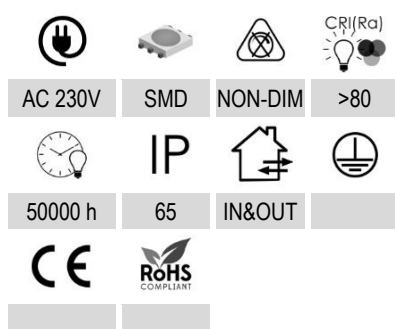

Uwagi / Komentář / Komentáre

PL: Zasilacz w komplecie

CZ: Napájení je součástí dodávky

SK: Napájanie je súčasťou dodávky

EN: Power supply included

Materiał / Materiál / Material

PL: aluminium

CZ: hliník

SK: hliník

EN: aluminum



PROMENAD



LAMPY PARKOWE LED

CZ: park LED lampy/ SK: park LED žiarovky/ EN: park LED lamps

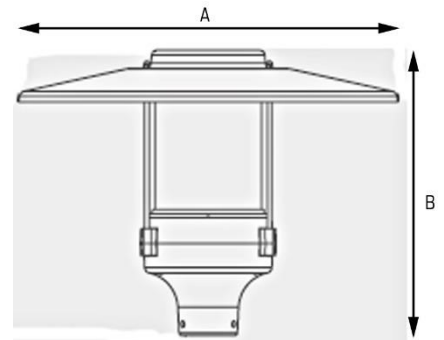

INDEX	ABC		Lm	PF	Tc[K]		A [mm]	B [mm]	
013678	Promenad LED	30W	2290 lm	0,95	3000 K	Czarny Černá Čierná Black	650	495	5902808804314
013677	Promenad LED	40W	3160 lm	0,95	3000 K		650	495	5902808804307
013684	Promenad LED	40W	3160 lm	0,95	4000 K		650	495	5902808804628
013683	Promenad LED	60W	4270 lm	0,95	4000 K		650	495	5902808804567



AC 230V



120°



NON-DIM



CRi(Ra)



50000 h



IP



IN&OUT

>80



RoHS
COMPLIANT

Materiał / Materiál / Material

PL: aluminium

CZ: hliník

SK: hliník

EN: aluminum

Uwagi / Komentář / Komentáre

PL: Zasilacz w komplecie

CZ: Napájení je součástí dodávky

SK: Napájanie je súčasťou dodávky

EN: Power supply included

BroLux

PROME INDERICT



LAMPY PARKOWE LED

CZ: park LED lampy/ SK: park LED žiarovky/ EN: park LED lamps

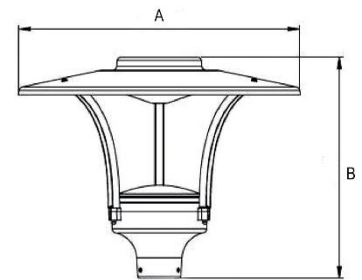

INDEX	ABC			Tc[K]		A [mm]	B [mm]	
012327	Prome LED	45W	3360 lm	4000 K	Czarny Černá Čierná Black	650	509	5902270314199

AC 230V	NON-DIM		
CRI/Ra	50000 h	65	IN&OUT

Materiał / Materiál / Material

PL: aluminium

CZ: hliník

SK: hliník

EN: aluminum

Uwagi / Komentář / Komentáre

PL: Zasilacz w komplecie

CZ: Napájení je součástí dodávky

SK: Napájanie je súčasťou dodávky

EN: Power supply included

BroLux

ADORA



LAMPY PARKOWE LED

CZ: park LED lampy/ SK: park LED žiarovky/ EN: park LED lamps

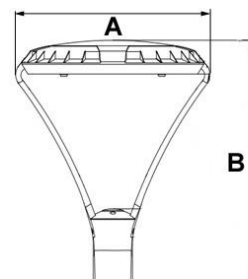

INDEX	ABC			Tc[K]		A [mm]	B [mm]	
013865	Adora LED	60W	9000 lm	4000 K	Szary Šedá Šedá Grey	450	523	5902808807186

Materiał / Materiál / Material

PL: aluminium

CZ: hliník

SK: hliník

EN: aluminum

Uwagi / Komentář / Komentáre

PL: Zasilacz w komplecie

CZ: Napájení je součástí dodávky

SK: Napájanie je súčasťou dodávky

EN: Power supply included



AC 230V



SMD



120x150°



NON-DIM



CRI/Ra



50000 h



IP



IN&OUT



RoHS
COMPLIANT

BroLux

TASK

NAŚWIETLACZ LED

CZ: veď sv tlomet / SK: vedie svetlomet / EN: LED floodlight

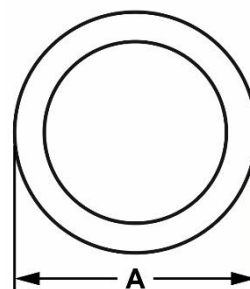
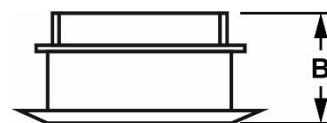

INDEX	ABC			Tc[K]		A [mm]	B [mm]	
006523	Task LED	10 W	1350 lm	6500 K	Szary �ed� �ed� Grey	145	88	5902216788503
008694	Task LED	10 W	1350 lm	4500 K		145	88	5902216771352
006522	Task LED	10 W	1350 lm	3000 K		145	88	5902216788510

AC 230V	COB LED	120°	NON-DIM
CRI(Ra)	>70	40000 h	65
			IN&OUT

Materia  / Materi l / Materi l

PL: aluminium

CZ: hlin k

SK: hlin k

EN: aluminum

Uwagi / Koment r / Koment re

PL: Zasilacz w komplecie

CZ: Nap jen  je sou ast  dod vky

SK: Nap janie je s u asťou dod vky

EN: Power supply included

Brolux

RODOS



NAŚWIETLACZ LED

CZ: vedl světlomet / SK: vedie svetlomet / EN: LED floodlight

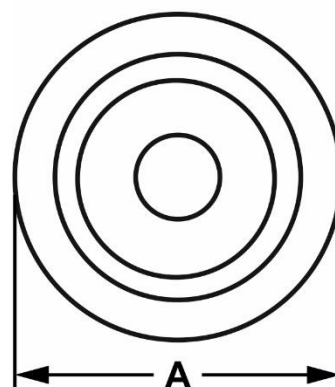
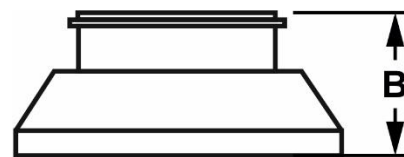

INDEX	ABC		Lm	Tc[K]		A [mm]	B [mm]	
006013	Rodos LED	30 W	3300 lm	6500 K	Czarny Černá Čierna Black	300	150	5902216788626
008700	Rodos LED	30 W	3300 lm	4500 K		300	150	5902216738058
006012	Rodos LED	30 W	3300 lm	3000 K		300	150	5902216788633
006015	Rodos LED	40 W	4400 lm	6500 K		300	150	5902216788640
006029	Rodos LED	50 W	5500 lm	6500 K		300	150	5902216788657
006030	Rodos LED	60 W	6500 lm	6500 K		300	150	5902216788664
006031	Rodos LED	70 W	7500 lm	6500 K		320	150	5902216788671
006032	Rodos LED	80 W	8500 lm	6500 K		320	150	5902216788688

AC 230V	COB LED	120°	NON-DIM
CRI(Ra)	40000 h	IP	IN&OUT
>70	CE	RoHS COMPLIANT	

Materiał / Materiál / Material

PL: aluminium

CZ: hliník

SK: hliník

EN: aluminum

Uwagi / Komentář / Komentáre

PL: Zasilacz w komplecie

CZ: Napájení je součástí dodávky

SK: Napájanie je súčasťou dodávky

EN: Power supply included

BLACK



NAŚWIETLACZ LED

CZ: veď sv etlomet / SK: vedie svetlomet / EN: LED floodlight

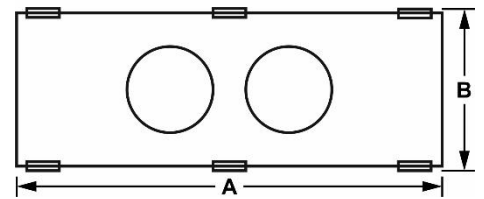
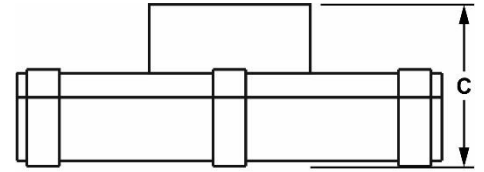

	INDEX	ABC				Tc[K]		A [mm]	B [mm]	C [mm]	
A	006034	Black LED	50 W	5000 lm	30°	6500 K	Czarny �ern�a �iern�a Black	370	285	93	5902216788527
A	008786	Black LED	50 W	5000 lm	30°	4500 K		370	285	93	5902216788534
A	005991	Black LED	50 W	5000 lm	30°	3000 K		370	285	93	5902216788541
A	006036	Black LED	80 W	8000 lm	30°	6500 K		370	285	93	5902216771710
B	006037	Black LED	100 W	10000 lm	35°	6500 K		570	285	93	5902216771703
B	006038	Black LED	120 W	12000 lm	35°	6500 K		570	285	93	5902216788558
B	006040	Black LED	160 W	16000 lm	35°	6500 K		570	285	93	5902216788565

AC 230V	COB LED	NON-DIM
CRI(Ra)	IP	IN&OUT
>75	40000 h	65
RoHS	CE	RoHS COMPLIANT

Materiał / Materiał / Material

PL: aluminium

CZ: hlin k

SK: hlin k

EN: aluminum

Uwagi / Koment r / Koment re

PL: Zasilacz w komplecie

CZ: Nap jení je sou ast  dod vky

SK: Nap janie je s u asťou dod vky

EN: Power supply included

NAŚWIETLACZ LED

CZ: vedl světlomet / SK: vedie svetlomet / EN: LED floodlight



	INDEX	ABC	⚡	💡 Lm	Tc[K]	📐	A [mm]	B [mm]	C [mm]	📊
A	006049	Sogo LED	50 W	5000 lm	6500 K	Czarny Černá Čierná Black	370	295	93	5902216771369
A	006050	Sogo LED	80 W	8000 lm	6500 K		370	295	93	5902216788701
A	006082	Sogo LED	100 W	10000 lm	6500 K		570	285	93	5902216788718
B	006087	Sogo LED	120 W	12000 lm	6500 K		570	285	93	5902216726239
B	006100	Sogo LED	160 W	16000 lm	6500 K		570	285	93	5902216788695
C	011538	Sogo LED	200 W	16000 lm	6500 K		900	290	115	5902216726253

⚡ AC 230V	💡 COB LED	☂️ 110°	⚠️ NON-DIM
💡(Ra) >75	🕒 40000 h	IP 65	🏠 IN&OUT
🌐	CE	RoHS COMPLIANT	

Materiał / Materiál / Material

PL: aluminium

CZ: hliník

SK: hliník

EN: aluminum

Uwagi / Komentář / Komentáře

PL: Zasilacz w komplecie

CZ: Napájení je součástí dodávky

SK: Napájanie je súčasťou dodávky

EN: Power supply included

NAŚWIETLACZ LED

CZ: veď sv etlomet / SK: vedie svetlomet / EN: LED floodlight

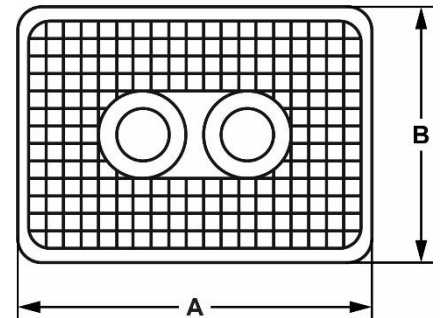
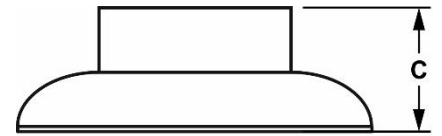

INDEX	ABC			Tc[K]		A [mm]	B [mm]	C [mm]	
006107	Plaza LED	80 W	8500 lm	6500 K	Czarny �ern�a �iern�a Black	450	307	130	5902216771550
006135	Plaza LED	100 W	11000 lm	6500 K		450	307	130	5902216788572
006136	Plaza LED	120 W	13000 lm	6500 K		450	307	130	5902216788589
006137	Plaza LED	150 W	16500 lm	6500 K		450	307	130	5902216788596
006138	Plaza LED	180 W	19500 lm	6500 K		450	307	130	5902216788602
006139	Plaza LED	210 W	23000 lm	6500 K		450	307	130	5902216788619

AC 230V	COB LED	100°	NON-DIM
CRI(Ra) >75	40000 h	IP 65	IN&OUT
RoHS COMPLIANT	CE	RoHS COMPLIANT	

Materiał / Materiał / Material

PL: aluminium

CZ: hlin ik

SK: hlin ik

EN: aluminum

Uwagi / Koment ar / Koment are

PL: Zasilacz w komplecie

CZ: Nap ajen i je sou ast i dod avky

SK: Nap ajanie je s u asťou dod avky

EN: Power supply included

NAŚWIETLACZ LED

CZ: veďl sv tľomet / SK: vedie svetľomet / EN: LED floodlight



		INDEX				Tc[K]		A	B	C	
			ABC		Lm			[mm]	[mm]	[mm]	
A		009970	Cedr LED	10 W	1000 lm	6500 K	Szary �ed� �ed� Grey	115	85	80	5902216737471
A		011342	Cedr LED	10 W	1000 lm	4500 K		115	85	80	5902216737488
A		011340	Cedr LED	20 W	2000 lm	6500 K		180	140	100	5902216788725
B		011341	Cedr LED	30 W	3000 lm	6500 K		225	185	110	5902216714359
B		009971	Cedr LED	50 W	5000 lm	6500 K		285	235	127	5902216721036
C		009972	Cedr LED	100 W	10000 lm	6500 K		285	365	100	5902216725904

AC 230V	COB LED	120°	NON-DIM
>75	40000 h	65	IN&OUT

Materiał / Materi al / Material

PL: aluminium
 CZ: hlin k
 SK: hlin k
 EN: aluminium

Uwagi / Koment r / Koment re

PL: Zasilacz w komplecie
 CZ: Nap jenn  je sou ast  dod vky
 SK: Nap janie je s u astou dod vky
 EN: Power supply included

ELF z akumulátorem



NAŚWIETLACZ LED

CZ: veďl sv tľomet / SK: vedie svetľomet / EN: LED floodlight

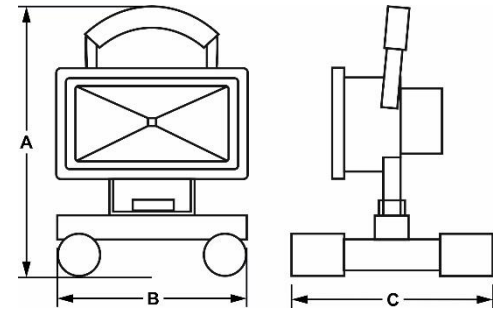

	INDEX	ABC	AC 230V	COB LED	120°	NON-DIM	CRI(Ra)	40000 h	65	IN&OUT	RoHS COMPLIANT	Czarny �ern� �iern� Black	A B C			5902216737495
													[mm]	[mm]	[mm]	
A	010462	Cedr LED	5 W	3,5h	8,4VDC	350 lm	6500 K					115	85	110	5902216737495	
A	009125	Cedr LED	10 W	3,5h	8,4VDC	650 lm	6500 K					115	85	110	5902216714366	
B	009126	Cedr LED	20 W	3,5h	8,4VDC	1300 lm	6500 K					178	138	130	5902216717480	

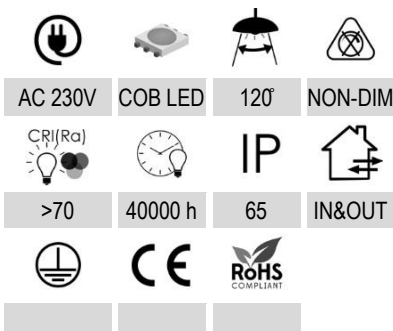

Materiał / Materi l / Materi l

PL: aluminium

CZ: hlin k

SK: hlin k

EN: aluminium

Uwagi / Koment r / Koment re

PL: Zasilacz w komplecie

CZ: Nap jen  je sou ast  dod vky

SK: Nap janie je s u astou dod vky

EN: Power supply included

NAŚWIETLACZ LED

CZ: veď sv etlomet / SK: vedie svetlomet / EN: LED floodlight



	INDEX	ABC			Tc[K]		A [mm]	B [mm]	C [mm]	
A	003817	Kord LED	10W	420 lm	6500 K	Czarny �ern�a �iern�a Black	115	85	40	5902216717497
A	002070	Kord LED	10W	420 lm	3000 K		115	85	40	5902216717503
B	003819	Kord LED	30W	2100 lm	6500 K		220	185	60	5902216717510
B	003828	Kord LED	30W	2100 lm	3000 K		220	185	60	5902216717527
C	003842	Kord LED	50W	3500 lm	6500 K		285	235	70	5902216717534
C	006641	Kord LED	50W	3500 lm	4500 K		285	235	70	5902216721043
C	003840	Kord LED	50W	3500 lm	3000 K		285	235	70	5902216717541
D	003844	Kord LED	100W	7000 lm	6500 K		460	310	90	5902216717558
D	010800	Kord LED	100W	7000 lm	4500 K		460	310	90	5902216721050
D	003846	Kord LED	100W	7000 lm	6500 K		460	310	90	5902216717565

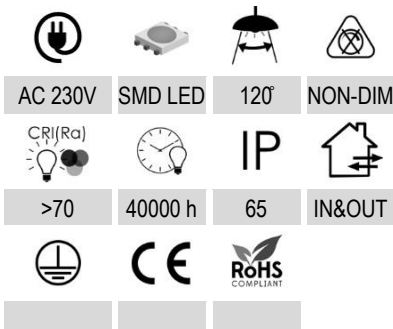

Materiał / Materi al / Materi al

PL: aluminium

CZ: hlin ik

SK: hlin ik

EN: aluminum

Uwagi / Koment ar / Koment are

PL: Zasilacz w komplecie

CZ: Nap ajen i je sou ast i dod avky

SK: Nap ajanie je s u asťou dod avky

EN: Power supply included

HARGO AC LED



NAŚWIETLACZ LED

CZ: vedl světlomet / SK: vedie svetlomet / EN: LED floodlight

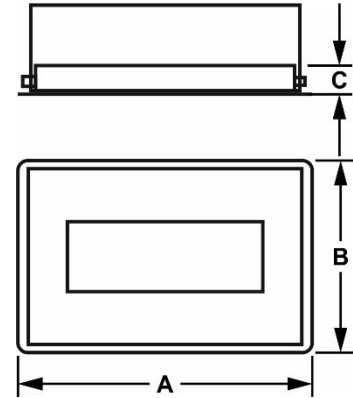

INDEX	ABC				Tc[K]					
							A [mm]	B [mm]	C [mm]	
007663	Hargo LED	50 W	4250 lm	85 lm/W	4500 K	Czarny Černá Čierná Black	245	170	28	5902216725393
007736	Hargo LED	50 W	4250 lm	85 lm/W	6500 K		245	170	28	5902216725416
012643	Hargo LED	100 W	8500 lm	85 lm/W	4500 K		351	262	45	5902216797505
007735	Hargo LED	100 W	8500 lm	85 lm/W	6500 K		351	262	45	5902216725409

AC 230V	SMD LED	120°	IP
70	40000 h	65	

Materiał / Materiál / Material

PL: aluminium

CZ: hliník

SK: hliník

EN: aluminum

Optymalne warunki eksploatacji:

Optimální provozní podmínky:

Optimálne prevádzkové podmienky:

Optimal operating conditions:

PL: temperatura.: od -10°C do +25°C

wilgotność: <85% ciśnienie: 690-1060 hPa

CZ: teplota: od -10 ° C do + 25 ° C

vlhkost: <85% tlak: 690-1060 hPa

SK: teplota: od -10 ° C do + 25 ° C

vlhkost: <85% tlak: 690-1060 hPa

EN: temperature: from -10 ° C to + 25 ° C

humidity: <85% pressure: 690-1060 hPa

Brolux

NAŚWIETLACZ LED

CZ: vedl světlomet / SK: vedie svetlomet / EN: LED floodlight



MW MODEL
MEAN WELL ELG

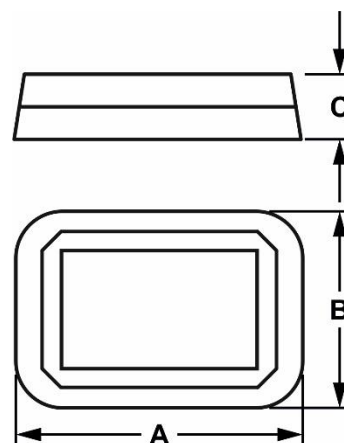

INDEX	ABC		Lm	Lm	Tc[K]		A [mm]	B [mm]	C [mm]	
012209	Jarda LED	200 W	28 000 lm	140 lm/W	6000 K	Szary Šedá Šedá Grey	412	320	126	5902216792173



AC 230V

LED

75°135°

80



40000 h

65

>0,95

IN&OUT



Uwagi / Komentář / Komentáre

PL: Zasilacz w komplecie

CZ: Napájení je součástí dodávky

SK: Napájanie je súčasťou dodávky

EN: Power supply included

Materiał / Materiál / Material

PL: aluminium

CZ: hliník

SK: hliník

EN: aluminum

Optymalne warunki eksploatacji:

Optimální provozní podmínky:

Optimálne prevádzkové podmienky:

Optimal operating conditions:

PL: temperatura.: od -25°C do +60°C

wilgotność: <85% ciśnienie: 690-1060 hPa

CZ: teplota: od -25°C do +60°C

vlhkost: <85% tlak: 690-1060 hPa

SK: teplota: od -25°C do +60°C

vlhkost: <85% tlak: 690-1060 hPa

EN: temperature: from -25°C do +60°C

humidity: <85% pressure: 690-1060 hPa

HAMZA



NAŚWIETLACZ LED

CZ: vedl světlomet / SK: vedie svetlomet / EN: LED floodlight



Driver



Model
HLG

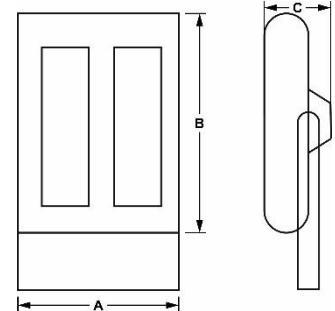

INDEX	ABC		Lm	Lm	Tc[K]		A [mm]	B [mm]	C [mm]	
012352	Hamza LED		75 000 lm	150 lm/W	5000 K		600	450	200	5902216794573

AC 230V	SMD LED	60°	IP
80	40000 h	65	

Uwagi / Komentář / Komentáre

PL: Zasilacz w komplecie

CZ: Napájení je součástí dodávky

SK: Napájanie je súčasťou dodávky

EN: Power supply included

Materiał / Materiál / Material

PL: aluminium

CZ: hliník

SK: hliník

EN: aluminum

Optymalne warunki eksploatacji:
Optimální provozní podmínky:
Optimálne prevádzkové podmienky:
Optimal operating conditions:

PL: temperatura.: od -25°C do +60°C
wilgotność: <85% ciśnienie: 690-1060 hPa

CZ: teplota: od -25°C do +60°C
vlhkost: <85% tlak: 690-1060 hPa

SK: teplota: od -25°C do +60°C
vlhkost: <85% tlak: 690-1060 hPa

EN: temperature: from -25°C do +60°C
humidity: <85% pressure: 690-1060 hPa



TATUM



NAŚWIETLACZ LED

CZ: vedl světlomet / SK: vedie svetlomet / EN: LED floodlight



Driver

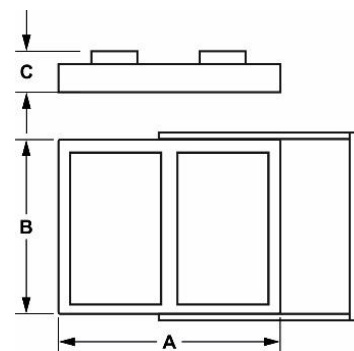

INDEX	ABC		Lm	Lm	Tc[K]		A [mm]	B [mm]	C [mm]	
012550	Tatum LED	500 W	70 000 lm	140 lm/W	4000 K		290	510	137	5902216796850

Materiał / Material / Material

PL: aluminium

CZ: hliník

SK: hliník

EN: aluminum

Optymalne warunki eksploatacji:

Optimální provozní podmínky:

Optimálne prevádzkové podmienky:

Optimal operating conditions:

PL: temperatura.: od -25°C do +60°C

wilgotność: <85% ciśnienie: 690-1060 hPa

CZ: teplota: od -25°C do +60°C

vlhkost: <85% tlak: 690-1060 hPa

SK: teplota: od -25°C do +60°C

vlhkost: <85% tlak: 690-1060 hPa

EN: temperature: from -25°C do +60°C

humidity: <85% pressure: 690-1060 hPa

Uwagi / Komentář / Komentáre

PL: Zasilacz w komplecie

CZ: Napájení je součástí dodávky

SK: Napájanie je súčasťou dodávky

EN: Power supply included

AC 230V	SMD LED	30°	IP	PF
70	50000 h	66	>0.90	
RoHS COMPLIANT	CE	RoHS COMPLIANT	RoHS COMPLIANT	

BroLux

www.bowi.com.pl

NAŚWIETLACZ LED

CZ: vedl světlomet / SK: vedie svetlomet / EN: LED floodlight

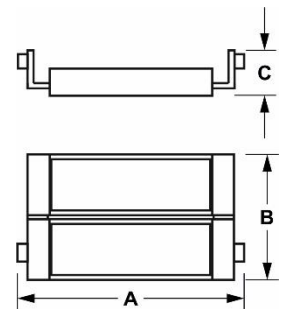

	INDEX	ABC		Lm	Lm		PF	Tc[K]		A [mm]	B [mm]	C [mm]	
A	012940	MADOR LED	50W	6 500 lm	130lm/W	70°×140°	≥0,95	4000 K	Szary Šedá Šedá Grey	350	75	75	5902216798946
A	012941	MADOR LED	50W	6 500 lm	130lm/W	70°×140°	≥0,95	5500 K		350	75	75	5902216798953
A	013334	MADOR LED	50W	6 500 lm	130lm/W	90°	≥0,95	4000 K		350	75	75	5902808800996
B	012598	MADOR LED	100W	13 000 lm	130lm/W	70°×140°	≥0,95	4000 K		350	155	75	5902216796966
B	012937	MADOR LED	100W	13 000 lm	130lm/W	70°×140°	≥0,95	5500 K		350	155	75	5902216798960
C	012938	MADOR LED	200W	26 000 lm	130lm/W	70°×140°	≥0,95	4000 K		350	315	75	5902216798977
C	012939	MADOR LED	200W	26 000 lm	130lm/W	70°×140°	≥0,95	5500 K		350	315	75	5902216798984
C	013332	MADOR LED	200W	26 000 lm	130lm/W	90°	≥0,95	4000 K		350	315	75	5902808801009
C	013333	MADOR LED	200W	26 000 lm	130lm/W	90°	≥0,95	5500 K		350	315	75	5902808801016

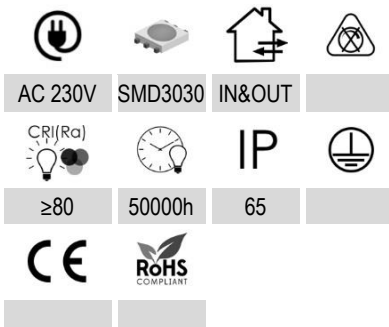

Uwagi / Komentář / Komentáre

PL: Zasilacz w komplecie

CZ: Napájení je součástí dodávky

SK: Napájanie je súčasťou dodávky

EN: Power supply included

Materiál / Material / Material

PL: aluminium

CZ: hliník

SK: hliník

EN: aluminum

Optymalne warunki eksploatacji:

Optimální provozní podmínky:

Optimálne prevádzkové podmienky:

Optimal operating conditions:

PL: temperatura: od -25°C do +60°C

wilgotność: <85% ciśnienie: 690-1060 hPa

CZ: teplota: od -25°C do +60°C

vlhkost: <85% tlak: 690-1060 hPa

SK: teplota: od -25°C do +60°C

vlhkost: <85% tlak: 690-1060 hPa

EN: temperature: from -25°C do +60°C

humidity: <85% pressure: 690-1060 hPa

NAŚWIETLACZ LED

CZ: vedl světlomet / SK: vedie svetlomet / EN: LED floodlight

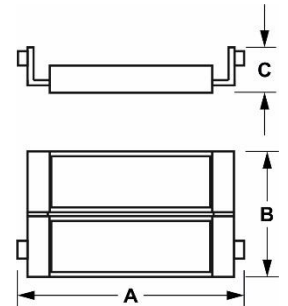

INDEX	ABC					PF	Tc[K]		A [mm]	B [mm]	C [mm]	
013879	MADOR LED	200W	22 050 lm	112lm/W	70°×140°	≥0,95	2700 K		350	315	75	5902808807438

AC 230V	SMD3030	IN&OUT	
		IP	
≥80	50000h	65	

Uwagi / Komentář / Komentáre

PL: Zasilacz w komplecie

CZ: Napájení je součástí dodávky

SK: Napájanie je súčasťou dodávky

EN: Power supply included

Materiał / Materiál / Material

PL: aluminium

CZ: hliník

SK: hliník

EN: aluminum

Optymalne warunki eksploatacji:

Optimální provozní podmínky:

Optimálne prevádzkové podmienky:

Optimal operating conditions:

PL: temperatura: od -25°C do +60°C

wilgotność: <85% ciśnienie: 690-1060 hPa

CZ: teplota: od -25°C do +60°C

vlhkost: <85% tlak: 690-1060 hPa

SK: teplota: od -25°C do +60°C

vlhkost: <85% tlak: 690-1060 hPa

EN: temperature: from -25°C do +60°C

humidity: <85% pressure: 690-1060 hPa

NAŚWIETLACZ LED

CZ: veďl sv tlomet / SK: vedie svetlomet / EN: LED floodlight

Driver

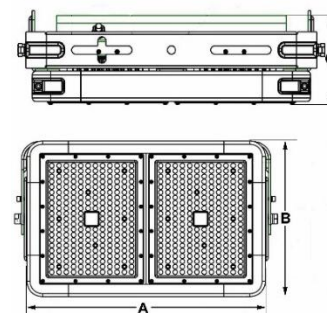

INDEX	ABC				Tc[K]		A [mm]	B [mm]	C [mm]	
012609	Paxton LED	200 W	27000 lm	135 lm/W	4500 K	Czarny Niebieski / C�rn� Modr� / C�rn� Modr� / Black Blue	300	250	120	5902216797000
012610	Paxton LED	360 W	50400 lm	140 lm/W	4500 K		460	300	150	5902216797017
012611	Paxton LED	540 W	75600 lm	140 lm/W	4500 K		670	300	150	5902216797024
012612	Paxton LED	720 W	108000 lm	150 lm/W	4500 K		560	460	150	5902216797031
012613	Paxton LED	1080 W	151200 lm	140 lm/W	4500 K		670	560	200	5902216797048
012614	Paxton LED	1440 W	201600 lm	140 lm/W	4500 K		880	560	200	5902216797055

Dost pne Akcesoria:

AC 230V	SMD3030	90°	NON-DIM
>80	50000 h	65	IN&OUT



013382 Soczewka 45°
do Paxton



013383 Soczewka 60°
do Paxton

Optymalne warunki eksploatacji:
Optim ln  provozn  podm nky:
Optim lnne prev dzkov  podm nky:
Optimal operating conditions:
PL: temperatura.: od -25°C do +60°C
wilgotno c: <85% ci nienie: 690-1060 hPa
CZ: teplota: od -25°C do +60°C
vlhkost: <85% tlak: 690-1060 hPa
SK: teplota: od -25°C do +60°C
vlhkost: <85% tlak: 690-1060 hPa
EN: temperature: from -25°C to +60°C
humidity: <85% pressure: 690-1060 hPa

Materia  / Materi l / Materi l

PL: aluminium

CZ: hlin k

SK: hlin k

EN: aluminum

Uwagi / Koment r / Koment re

PL: Zasilacz w komplecie

CZ: Nap jen  je sou ast  dod vky

SK: Nap janie je s u astou dod vky

EN: Power supply included

WALL WASHER LED

CZ: LED dioda na stěnové podložce / SK: LED dióda na stenách / EN: LED wallwasher



INDEX	ABC				Tc[K]		A [mm]	B [mm]	C [mm]	
6831	Aland LED	18 W	1620 lm	90 lm/W	3500 K	Szary Šedá Šedá Grey	600	72	66	5902216784147
6812	Aland LED	18 W	1620 lm	90 lm/W	4500 K		600	72	66	5902216784130
6823	Aland LED	18 W	1620 lm	90 lm/W	6500 K		600	72	66	5902216788756
003346	Aland LED	36 W	3600 lm	100 lm/W	4500 K		1200	72	66	5902216714489
007466	Aland LED	36 W	3600 lm	100 lm/W	3500 K		1200	72	66	5902216714496
009645	Aland LED	36 W	3600 lm	100 lm/W	6500 K		1200	72	66	5902216784123

AC 230V	Power LED	25°	NON-DIM
CRi(Ra)	IP	IN&OUT	
>70	40000 h	65	
≥0.55			

Uwagi / Komentář / Komentáre

PL: Zasilacz w komplecie

CZ: Napájení je součástí dodávky

SK: Napájanie je súčasťou dodávky

EN: Power supply included

Materiał / Materiál / Material

PL: aluminium

CZ: hliník

SK: hliník

EN: aluminum

Optymalne warunki eksploatacji:

Optimální provozní podmínky:

Optimálne prevádzkové podmienky:

Optimal operating conditions:

PL: temperatura.: od -25°C do +60°C

wilgotność: <85% ciśnienie: 690-1060 hPa

CZ: teplota: od -25°C do +60°C

vlhkost: <85% tlak: 690-1060 hPa

SK: teplota: od -25°C do +60°C

vlhkost: <85% tlak: 690-1060 hPa

EN: temperature: from -25°C do +60°C

humidity: <85% pressure: 690-1060 hPa

WALL WASHER LED

CZ: LED dioda na stěnové podložce / SK: LED dióda na stenách / EN: LED wallwasher



PHILIPS

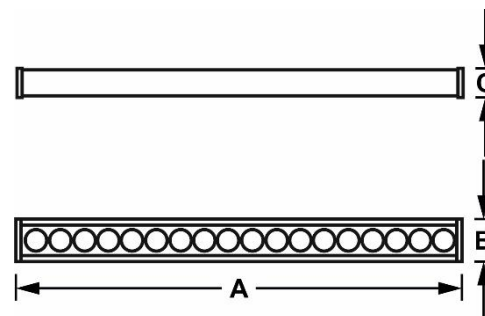

INDEX	ABC				Tc[K]		A [mm]	B [mm]	C [mm]	
012857	Garan LED	24W	1800 lm	75 lm/W	4000 K	Szary Šedá Šedá Grey	600	46,5	70	5902216798328
012882	Garan LED	36W	2700 lm	75 lm/W	3000 K		1000	45	59	5902216798373
012856	Garan LED	36W	2700 lm	75 lm/W	4000 K		1000	45	59	5902216797987

AC 230V	SMD	30°	NON-DIM
CRI/Ra	40000 h	IP 65	IN&OUT
80	40000 h	65	IN&OUT
PF 0,9			

Materiał / Materiál / Material

PL: aluminium

CZ: hliník

SK: hliník

EN: aluminum

Optymalne warunki eksploatacji:

Optimální provozní podmínky:

Optimálne prevádzkové podmienky:

Optimal operating conditions:

PL: temperatura.: od -25°C do +60°C

wilgotność: <85% ciśnienie: 690-1060 hPa

CZ: teplota: od -25°C do +60°C

vlhkost: <85% tlak: 690-1060 hPa

SK: teplota: od -25°C do +60°C

vlhkost: <85% tlak: 690-1060 hPa

EN: temperature: from -25°C do +60°C

humidity: <85% pressure: 690-1060 hPa

Uwagi / Komentář / Komentáre

PL: Zasilacz w komplecie

CZ: Napájení je součástí dodávky

SK: Napájanie je súčasťou dodávky

EN: Power supply included

OPRAWY DOGRUNTOWE

CZ: svítidlo dogruntowe / SK: svietidlo dogruntowe / EN: In ground light



A



B

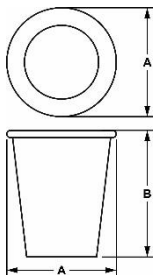

	INDEX	ABC	⚡	💡 Lm	Tc[K]	🔍	A [mm]	B [mm]	📊
A	010452	Pelia LED	10 W	600 lm	3500 K	Srebrny Sřibrná sřibrná silver	160	93	5902216714410
A	010453	Pelia LED	10 W	600 lm	4500 K		160	93	5902216711969
B	013670	Pelia LED	20 W	1659 lm	4000 K		210	110	5902808804338
B	010455	Pelia LED	30 W	18000 lm	3500 K		250	97	5902216711976
B	010454	Pelia LED	30 W	18000 lm	4500 K		250	97	5902216711983

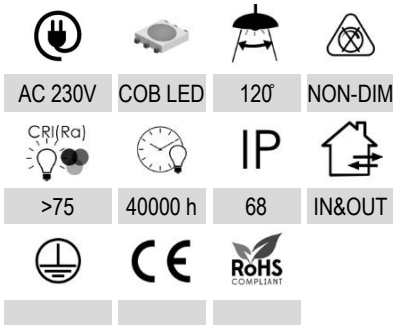

Materiał / Materiał / Material

PL: aluminium

CZ: hliník

SK: hliník

EN: aluminum

Uwagi / Komentář / Komentáre

PL: Zasilacz w komplecie

CZ: Napájení je součástí dodávky

SK: Napájanie je súčasťou dodávky

EN: Power supply included

SIBAR



OPRAWY DOGRUNTOWE

CZ: svítidlo dogruntowe / SK: svetidlo dogruntowe / EN: In ground light



A



B



C



D



E

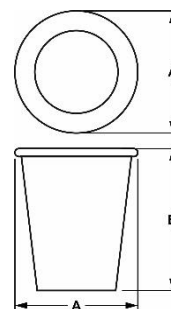

INDEX



A [mm]

B [mm]



	INDEX	ABC	Power	lm/W	lm	K		A [mm]	B [mm]	Barcode
A	007481	Sibar LED	3 W	70 lm/W	210 lm	3500 K	Srebrny Stříbrná stříbrná silver	100	78	5902216706750
A	007484	Sibar LED	3 W	70 lm/W	210 lm	4500 K		100	78	5902216714427
A	011376	Sibar LED	3 W	70 lm/W	210 lm	6500 K		100	78	5902216714434
A	010458	Sibar LED	3 W			RGB		100	78	5902216758346
B	007491	Sibar LED	5 W	70 lm/W	350 lm	3500 K		120	92	5902216711990
B	007487	Sibar LED	5 W	70 lm/W	350 lm	4500 K		120	92	5902216723764
B	010457	Sibar LED	5 W			RGB		120	92	5902216739123
C	007498	Sibar LED	7 W	70 lm/W	490 lm	3500 K		120	92	5902216712003
C	007502	Sibar LED	7 W	70 lm/W	490 lm	4500 K		120	92	5902216723771
C	007668	Sibar LED	7 W			Czerwony		120	92	5902216758353
C	007851	Sibar LED	7 W			Niebieski		120	92	5902216739130
C	010456	Sibar LED	7 W			RGB		120	92	5902216739147
D	007535	Sibar LED	9 W	70 lm/W	630 lm	3500 K		150	92	5902216714441
D	007529	Sibar LED	9 W	70 lm/W	630 lm	4500 K		150	92	5902216714458
E	007536	Sibar LED	12 W	70 lm/W	840 lm	3500 K		180	94	5902216712010
E	007595	Sibar LED	12 W	70 lm/W	840 lm	4500 K		181	94	5902216723788
E	011410	Sibar LED	12 W			RGB	182	94	5902216758360	



AC 230V

Power LED

30°

NON-DIM



IP



>75

40000 h

68

IN&OUT



Uwagi / Komentář / Komentáre

PL: Zasilacz w komplecie

CZ: Napájení je součástí dodávky

SK: Napájanie je súčasťou dodávky

EN: Power supply included

Materiał / Materiál / Materiál

PL: aluminium

CZ: hliník

SK: hliník

EN: aluminum

Optymalne warunki eksploatacji:

Optimální provozní podmínky:

Optimálne prevádzkové podmienky:

Optimal operating conditions:

PL: temperatura.: od -25°C do +60°C

wilgotność: <85% ciśnienie: 690-1060 hPa

CZ: teplota: od -25°C do +60°C

vlhkost: <85% tlak: 690-1060 hPa

SK: teplota: od -25°C do +60°C

vlhkosť: <85% tlak: 690-1060 hPa

EN: temperature: from -25°C do +60°C

humidity: <85% pressure: 690-1060 hPa

Brolux

OPRAWY DOGRUNTOWE

CZ: Pozemní světlo / SK: Pozemné svetlo / EN: Ground Light



A	002229	Callissa LED	1×7W	190 lm	4500 K	Czarny Černá Čierny Black	15°	IP67	Power LED	125	140	5902216770973
B	001819	Flat LED	12×0,1 W	50 lm	3500 K		40°	IP54	Power LED	126	74	5902216770843
C	001892	Glow LED	6×0,1 W	43 lm	3500 K		15°	IP54	Power LED	95	70	5902216719101
D	292	Jayarl LED	3 W	150 lm	3500 K		120°	IP54	Power LED	120	140	5902216719064
E	110	Lawa LED	3 W	200 lm	3500 K		120°	IP54	Power LED	126	80	5902216770744
F	012868	Sibar	3×1W		4000 K					110	88	5902216798250
G	012812	Blum LED	16×0,1	100 lm	3000 K		120°	IP52		95		5902216719187



AC 230V

POWER
LED

NON-DIM



>75

40000 h

IN&OUT



Materiał / Materiál / Materiál

PL: aluminium

CZ: hliník

SK: hliník

EN: aluminum

Optymalne warunki eksploatacji:

Optimální provozní podmínky:

Optimálne prevádzkové podmienky:

Optimal operating conditions:

PL: temperatura.: od -25°C do +60°C

wilgotność: <85% ciśnienie: 690-1060 hPa

CZ: teplota: od -25°C do +60°C

vlhkost: <85% tlak: 690-1060 hPa

SK: teplota: od -25°C do +60°C

vlhkost: <85% tlak: 690-1060 hPa

EN: temperature: from -25°C to +60°C

humidity: <85% pressure: 690-1060 hPa

Uwagi / Komentář / Komentáre

PL: Zasilacz w komplecie

CZ: Napájení je součástí dodávky

SK: Napájanie je súčasťou dodávky

EN: Power supply included

OPRAWY NAJAZDOWE

CZ: Svítidla bez zdroje světla / SK: Svetidlá bez zdroja svetla / EN: Luminaires without a light source



A



B

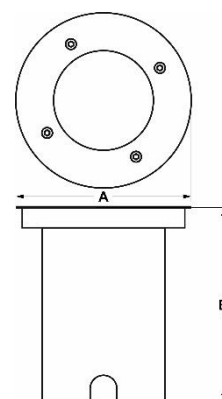

	INDEX	ABC		A [mm]	B [mm]	
A	012811		Czarny Černá Čierná Black	107	146	5902216798069
D	012812			107	143	5902216798076

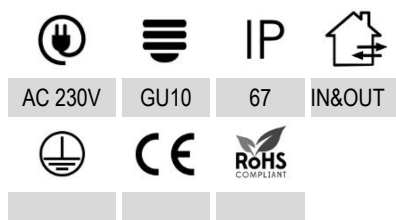

Materiał / Materiál / Material
PL: aluminium
CZ: hliník
SK: hliník
EN: aluminium

TERTA



REFLEKTORY LED

CZ: LED světlomety / SK LED bodové svetlá: / EN: LED floodlight



INDEX	ABC			Tc[K]		W×H×D	
010459	TERTA LED	3 W	180 lm	3500K	Szary Šedá Šedá Grey	120 × 95mm	5902216712027
010460	TERTA LED	3 W	180 lm	4500K		120 × 95mm	5902216714465
010461	TERTA LED	3 W	180 lm	RGB		120 × 95mm	5902216761193
011501	TERTA LED	3 W	180 lm	Czerwony		120 × 95mm	5902216746121
011500	TERTA LED	3 W	180 lm	Niebieski		120 × 95mm	5902216746138
011502	TERTA LED	3 W	180 lm	Zielony		120 × 95mm	5902216746145

AC 230V	Power LED	30°	NON-DIM
>75	40000 h	68	IN&OUT

Materiał / Materiál / Material

PL: aluminium

CZ: hliník

SK: hliník

EN: aluminum

Uwagi / Komentář / Komentáre

PL: Zasilacz w komplecie

CZ: Napájení je součástí dodávky

SK: Napájanie je súčasťou dodávky

EN: Power supply included

REFLEKTORKI



REFLEKTORY LED

CZ: Reflektory LED / SK: Reflektory LED / EN: Spotlights LED



A



B

	INDEX	ABC	⚡	💡	Tc[K]	📐	A [mm]	B [mm]	📊
A	001882	Macy LED	3×1 W	305 lm	3500K	Czarny Černá Čierná Black	135	390	5902216789746
B	005772	Maris LED	3×1 W	305 lm	3500 K		63	61	5902216719132

⚡	💡	☂️	♻️
AC 230V	SMD LED	120°	NON-DIM
CRi(Ra)	🕒	IP	🏠
>80	40000 h	54	IN&OUT
🌐	CE	RoHS COMPLIANT	

Materiał / Materiál / Material

PL: aluminium

CZ: hliník

SK: hliník

EN: aluminium

Uwagi / Komentář / Kommentäre

PL: Zasilacz w komplecie

CZ: Napájení je součástí dodávky

SK: Napájanie je súčasťou dodávky

EN: Power supply included

Brolux

OPRAWY ELEWACYJNE

ARCHITEKTONICZNE LAMPY LED

CZ: fasádní lampy LED / SK: fasádne LED svietidlá / EN: elevational LED lamps



A



B



C



D



E



F



G



H



I



J



K



L



M



N



O

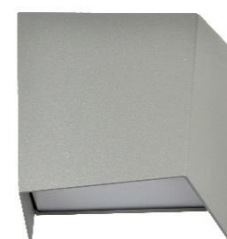

P



R



S



T



ARCHITEKTONICZNE LAMPY LED

CZ: fasádní lampy LED / SK: fasádne LED svietidlá / EN: elevational LED lamps



A	009539	Barr LED	9 W	300 lm	3500 K	Szary Šedá Šedá Grey	120°	0.8	SMD LED	5902216738188
B	009553	Benon LED	10 W	300 lm	3500 K		120°	0.8	SMD LED	5902216789586
C	009556	Berad LED	8 W	450 lm	3500 K		120°	0.8	SMD LED	5902216738195
D	009523	Carri LED	3 W	130 lm	4500 K		30°	0.5	Power LED	5902216720138
E	009536	Ciolla LED	3 W	130 lm	4500 K		30°	0.5	Power LED	5902216738201
F	009533	Cissa LED	2 W	150 lm	4500 K		60°	0.5	Power LED	5902216738218
G	009309	Dacu LED	3 W	170lm	4500 K		30°	0.5	Power LED	5902216739116
H	011483	Elkim LED	4 W	190 lm	4500 K		90°	0.55	Power LED	5902216739154
I	009558	Fray LED	8 W	450 lm	3500 K		120°	0.8	SMD LED	5902216739161
J	009579	Froda LED	12 W	650 lm	3500 K		120°	0.8	SMD LED	5902216739178
K	009584	Jonas LED	18 W	900 lm	3500 K		120°	0.9	SMD LED	5902216739185
L	009582	Jordi LED	3 W	130 lm	3500 K		120°	0.5	SMD LED	5902216739192
M	011481	Jordi LED	12 W	650 lm	3500 K		120°	0.8	SMD LED	5902216739208
N	009520	Ninion LED	2 W	80 lm	4500 K		30°	0.5	Power LED	5902216739215
O	009308	Parish LED	4 W	240 lm	4500 K		30°	0.5	Power LED	5902216739222
P	009404	Parr LED	4 W	120 lm	4500 K		120°	0.5	Power LED	5902216739239
R	011431	Qita LED	2 W	40 lm	4500 K		80°	0.5	Power LED	5902216720121
S	011449	Rust LED	2 W	75 lm	4500 K		80°	0.5	Power LED	5902216739246
T	011473	Uffa LED	12 w	750 lm	4500 K		40°	0.5	SMD LED	5902216739253



AC 230V NON-DIM IN&OUT



>75 40000 h 54



Materiał / Materiál / Material

PL: aluminium

CZ: hliník

SK: hliník

EN: aluminium

Uwagi / Komentář / Komentáře

PL: Zasilacz w komplecie

CZ: Napájení je součástí dodávky

SK: Napájanie je súčasťou dodávky

EN: Power supply included

ARCHITEKTONICZNE LAMPY LED

CZ: fasádní lampy LED / SK: fasádne LED svietidlá / EN: elevational LED lamps



OPRAWY ELEWACYJNE

ARCHITEKTONICZNE LAMPY LED

CZ: fasádní lampy LED / SK: fasádne LED svietidlá / EN: elevational LED lamps



INDEX



IP



A	004478	Birk LED	30 W	2100 lm	4500 K	Czarny Černá Čierná Black	95°	IP65	COB	5902216771062
B	004492	Bitel LED	18 W	1620 lm	4500 K		40°	IP65	COB	5902216771055
C	005774	Brick LED	14×0,5 W	240 lm	4000 K		120°	IP54	Power LED	5902216770997
D	007478	Cissa LED	2 W	202 lm	3500 K		115°	IP54	Power LED	5902216719071
E	004727	Double LED	2×3 W	150 lm	3500 K		80°	IP54	Power LED	5902216770904
E	1214	Double LED	3 W	400 lm	3500 K		80°	IP54	Power LED	5902216770898
F	006347	Duck LED	4×1 W	200 lm	3500 K		100°	IP54	Power LED	5902216770881
G	001820	Elkim LED	4 W	402 lm	3500 K		120°	IP54	Power LED	5902216719088
G	009320	Elkim LED	4 W	190 lm	4500 K		90°	IP54	Power LED	5902216712492
H	1039	Falin LED	18 W	800 lm	3500 K		120°	IP54	Power LED	5902216770867
I	001890	Fuku LED	2×1 W	203 lm	3500 K		115°	IP54	Power LED	5902216719095
J	001579	Gracin LED	6 W	360 lm	3500 K		30°	IP54	Power LED	5902216719705
K	5553	Gracin LED	12 W	350 lm	3500 K		115°	IP54	Power LED	5902216770836
L	002613	Gracin LED	12 W	1000 lm	3500 K		30°	IP54	Power LED	5902216719224
M	006346	Grif LED	2×1 W	200 lm	3500 K		115°	IP54	Power LED	5902216719163
N	251	Hagenal LED	10 W	800 lm	3500 K		120°	IP54	SMD LED	5902216718982
O	001050	Harli LED	2×7 W	320 lm	4500 K		270°	IP54	Power LED	5902216789708
P	001889	Helik LED	2×3 W	205 lm	3500 K		115°	IP54	Power LED	5902216719118
P	002636	Helik LED	1×3 W	180 lm	3500 K		80°	IP54	Power LED	5902216789715
R	008041	Jake LED	2×1 W	100 lm	3500 K		50°	IP54	Power LED	5902216770805
S	002584	Javan LED	25×0,2 W	200 lm	3500 K	120°	IP44	Power LED	5902216770799	
T	001047	Javen LED	18×0,5 W	600 lm	3500 K	120°	IP44	Power LED	5902216770782	
U	001341	Julet LED	2×1 W	100 lm	3500 K	50°	IP54	Power LED	5902216770775	



AC 230V



NON-DIM



IN&OUT



CR|(Ra)



>75



40000 h



Materiał / Materiál / Material

PL: aluminium

CZ: hliník

SK: hliník

EN: aluminum

Uwagi / Komentář / Komentáre

PL: Zasilacz w komplecie

CZ: Napájení je součástí dodávky

SK: Napájanie je súčasťou dodávky

EN: Power supply included



ARCHITEKTONICZNE LAMPY LED

CZ: fasádní lampy LED / SK: fasádne LED svietidlá / EN: elevational LED lamps



A



B



C



D



E



F



G



H



I



J



K



L



M



N



O



P



R



S



T



U

OPRAWY ELEWACYJNE

ARCHITEKTONICZNE LAMPY LED

CZ: fasádní lampy LED / SK: fasádne LED svietidlá / EN: elevational LED lamps



A	5476	Karrell LED	3 W	200 lm	3500 K	Czarny Černá Čierna Black	120°	IP54	Power LED	5902216770768
B	1335	Mathe LED	6 W	480 lm	3500 K		120°	IP54	Power LED	5902216718999
C	008040	Nira LED	12×0,5 W	660 lm	3500 K		120°	IP54	Power LED	5902216719170
D	003150	Onix LED	7 W	206 lm	3500 K		120°	IP54	Power LED	5902216719125
E	002012	Ortal LED	5 W	290 lm	3500 K		120°	IP54	SMD LED	5902216721449
F	007395	Oryan LED	10 W	400 lm	3500 K		115°	IP54	Power LED	5902216789722
G	004512	Osmar LED	7 W	300 lm	3500 K		115°	IP54	Power LED	5902216788947
H	007467	Pocel LED	4 W	480 lm	3500 K		120°	IP54	SMD LED	5902216719002
I	5858	Pryde LED	20 W	900 lm	3500 K		120°	IP54	SMD LED	5902216721463
J	1236	Qiana LED	36×0,1 W	100 lm	3500 K		150°	IP54	Power LED	5902216770638
K	004770	Rees LED	10 W	800 lm	3500 K		120°	IP54	SMD LED	5902216719019
L	003237	Ronell LED	5 W	400 lm	3500 K		120°	IP54	SMD LED	5902216719026
M	002658	Rotri LED	2×5 W	800 lm	3500 K		120°	IP54	Power LED	5902216718951
N	6327	Saxan LED	3 W	160 lm	3500 K		120°	IP54	Power LED	5902216770553
O	5741	Scytta LED	6 W	320 lm	3500 K		120°	IP54	Power LED	5902216717053
P	3628	Sebald LED	3 W	160 lm	3500 K		120°	IP54	Power LED	5902216770546
R	3616	Sebald LED	2×3 W	320 lm	3500 K		120°	IP54	Power LED	5902216717060
S	3600	Sebbe LED	2×3 W	380 lm	3500 K		120°	IP54	Power LED	5902216717077
T	3534	Sebert LED	3 W	190 lm	3500 K		120°	IP54	Power LED	5902216770539
U	6060	Secga LED	6 W	480 lm	3500 K		120°	IP54	Power LED	5902216770522

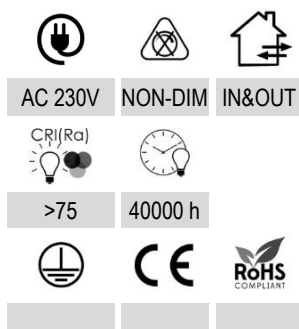

Materiał / Materiál / Material

PL: aluminium

CZ: hliník

SK: hliník

EN: aluminum

Uwagi / Komentář / Komentáre

PL: Zasilacz w komplecie

CZ: Napájení je součástí dodávky

SK: Napájanie je súčasťou dodávky

EN: Power supply included



OPRAWY ELEWACYJNE



ARCHITEKTONICZNE LAMPY LED

CZ: fasádní lampy LED / SK: fasádne LED svietidlá / EN: elevational LED lamps



	INDEX	ABC		Lm	Tc[K]				
A	000241	Selby LED	6 W	600 lm	3500 K	Czarny Černá Čierná Black	120°	SMD LED	5902216719644
B	001049	Tacara LED	4×1 W	380 lm	4500 K		30°	Power LED	5902216770508
C	001272	Tally LED	5 W	500 lm	3500 K		50°	Power LED	5902216770492
D	5261	Yuba LED	1×7 W	340 lm	4500 K		120°	Power LED	5902216770423

AC 230V	NON-DIM	IN&OUT
CRI(Ra)	IP	
>75	40000 h	54
CE	RoHS COMPLIANT	

Materiał / Materiál / Material

PL: aluminium
 CZ: hliník
 SK: hliník
 EN: aluminum

Uwagi / Komentář / Komentáre

PL: Zasilacz w komplecie
 CZ: Napájení je součástí dodávky
 SK: Napájanie je súčasťou dodávky
 EN: Power supply included



ARCHITEKTONICZNE LAMPY LED

CZ: LED svítidlo/ SK: LED svetidlo/ EN: LED lamp



	INDEX				Tc[K]		A [mm]	B [mm]	C [mm]	
A	013062	Flow LED	1x3 W	270 lm	4000 K	Zieleń mchu RAL 6005 Mehově zelená RAL 6005 Machovo zelená RAL 6005 Moss green RAL 6005	114	28	83	5902216799738
B	013063	Flow LED	1x3 W	270 lm	4000 K	Czarny Černá Čierny Black	114	28	83	5902216799745
C	013636	Flow LED	1x3 W	270 lm	4000 K	Antracytowy RAL 7016 antracitová RAL 7016 antracitová RAL 7016 anthracite RAL 7016	114	28	83	5902808804512
D	013064	Flow LED	1x6 W	540 lm	4000 K	Zieleń mchu RAL 6005 Mehově zelená RAL 6005 Machovo zelená RAL 6005 Moss green RAL 6005	172	29	83	5902216799752
E	013065	Flow LED	1x6 W	540 lm	4000 K	Czarny Černá Čierny Black	172	29	83	5902216799769
F	013637	Flow LED	1x6 W	540 lm	4000 K	Antracytowy RAL 7016 antracitová RAL 7016 antracitová RAL 7016 anthracite RAL 7016	172	29	83	5902808804529
G	013066	Flow LED	1x9 W	810 lm	4000 K	Zieleń mchu RAL 6005 Mehově zelená RAL 6005 Machovo zelená RAL 6005 Moss green RAL 6005	250	30	83	5902216799776
H	013639	Flow LED	1x9 W	810 lm	4000 K	Czarny Černá Čierny Black	250	30	83	5902808804536
I	013638	Flow LED	1x9 W	810 lm	4000 K	Antracytowy RAL 7016 antracitová RAL 7016 antracitová RAL 7016 anthracite RAL 7016	250	30	83	5902808804543

AC 230V
 SMD LED
 60
 NON-DIM
 CRI(Ra) >80
 40000 h
 IP 54
 IN&OUT
 CE
 RoHS COMPLIANT

Materiał / Materiál / Material
 PL: aluminium
 CZ: hliník
 SK: hliník
 EN: aluminium

Uwagi / Komentář / Komentáre
 PL: Zasilacz w komplecie
 CZ: Napájení je součástí dodávky
 SK: Napájanie je súčasťou dodávky
 EN: Power supply included

ARCHITEKTONICZNE LAMPY LED

CZ: LED svítidlo/ SK: LED svetidlo/ EN: LED lamp



INDEX



A [mm]

B [mm]

C [mm]



	INDEX	ABC	Power	Lm	Tc[K]	Color	A [mm]	B [mm]	C [mm]	Barcode
A	012878	Flow LED	2x3 W	540 lm	4000K	Zieleń mchu RAL 6005 Mechově zelená RAL 6005 Machovo zelená RAL 6005 Moss green RAL 6005	114	28	90	5902216789746
B	013069	Flow LED	2x3 W	540 lm	4000 K	Czarny Černá Čierny Black	114	28	90	5902216799783
C	013640	Flow LED	2x3 W	540 lm	4000 K	Antracytowy RAL 7016 antracitová RAL 7016 antracitová RAL 7016 anthracite RAL 7016	114	28	90	5902808804550
D	012879	Flow LED	2x6 W	1080 lm	4000 K	Zieleń mchu RAL 6005 Mechově zelená RAL 6005 Machovo zelená RAL 6005 Moss green RAL 6005	172	28	90	5902216719132
E	013068	Flow LED	2x6 W	1080 lm	4000 K	Czarny Černá Čierny Black	172	28	90	5902216799806
F	013067	Flow LED	2x9 W	1620 lm	4000 K	Zieleń mchu RAL 6005 Mechově zelená RAL 6005 Machovo zelená RAL 6005 Moss green RAL 6005	250	28	90	5902216799790



AC 230V



SMD LED



60



NON-DIM



CRI/Ra



40000 h



54



IN&OUT



Materiał / Materiál / Materiál

PL: aluminium

CZ: hliník

SK: hliník

EN: aluminium

Uwagi / Komentář / Komentáre

PL: Zasilacz w komplecie

CZ: Napájení je součástí dodávky

SK: Napájanie je súčasťou dodávky

EN: Power supply included

Br^olux

ARCHITEKTONICZNE LAMPY LED

CZ: LED svítidlo/ SK: LED svetidlo/ EN: LED lamp

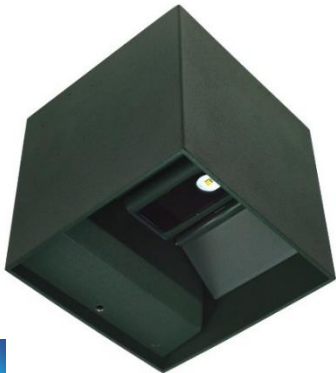

A

B

C

D



E

F

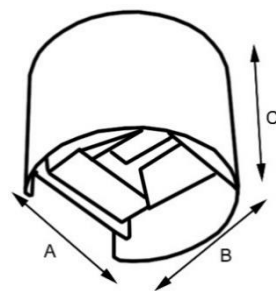

INDEX



A [mm]



B [mm]

C [mm]



						A [mm]	B [mm]	C [mm]	
A	013073	Kreon LED	2x3 W	196 lm	4000 K	100	100	100	5902216799813
B	013072	Kreon LED	2x3 W	196 lm	4000 K	100	100	100	5902216799820
C	013634	Kreon LED	2x3 W	196 lm	4000 K	100	100	100	5902808804475
D	013635	Kreon LED	2x3 W	196 lm	4000 K	100	100	100	5902808804482
E	013070	Kreon LED	2x3 W	196 lm	4000 K	130	108	98	5902216799837
F	013071	Kreon LED	2x3 W	196 lm	4000 K	130	108	98	5902216799844



AC 230V



SMD LED



0-120°



NON-DIM



CRI(Ra)



IP



IN&OUT

>80

40000 h

54

IN&OUT



Materiał / Materiál / Material

PL: aluminium

CZ: hliník

SK: hliník

EN: aluminium

Uwagi / Komentář / Komentáre

PL: Zasilacz w komplecie

CZ: Napájení je součástí dodávky

SK: Napájanie je súčasťou dodávky

EN: Power supply included

Brolux

ARCHITEKTONICZNE LAMPY LED

CZ: LED svítidlo/ SK: LED svetidlo/ EN: LED lamp



INDEX



A
[mm]

B
[mm]

C
[mm]



	INDEX			lm	Tc[K]		A [mm]	B [mm]	C [mm]	
A	013075	Surmur LED	1x6 W	390 lm	4000 K	Zieleń mchu RAL 6005 Mechově zelená RAL 6005 Machovo zelená RAL 6005 Moss green RAL 6005	107	78	78	5902216799851
B	013074	Surmur LED	1x6 W	390 lm	4000 K	Czarny Černá Čierny Black	107	78	78	5902216799868
C	013076	Surmur LED	2x6 W	710 lm	4000 K	Zieleń mchu RAL 6005 Mechově zelená RAL 6005 Machovo zelená RAL 6005 Moss green RAL 6005	185	67	105	5902216799875
D	013077	Surmur LED	2x6 W	710 lm	4000 K	Czarny Černá Čierny Black	185	67	105	5902216799882



AC 230V



SMD LED



120°



NON-DIM



≥80



40000 h



54



IN&OUT



Materiał / Materiál / Material

PL: aluminium

CZ: hliník

SK: hliník

EN: aluminium

Uwagi / Komentář / Komentáre

PL: Zasilacz w komplecie

CZ: Napájení je součástí dodávky

SK: Napájanie je súčasťou dodávky

EN: Power supply included

ARCHITEKTONICZNE LAMPY LED

CZ: LED svítidlo / SK: LED svetidlo / EN: LED lamp



INDEX	ABC			Tc[K]		A [mm]	B [mm]	C [mm]	
013457	Gloss LED	9 W		4000 K	Czarny Černá Čierny Black	220	100	150	5902808802631

AC 230V	SMD LED		NON-DIM
	40000 h	54	IN&OUT
PIR			

Materiał / Materiál / Material

PL: aluminium

CZ: hliník

SK: hliník

EN: aluminium

Uwagi / Komentář / Komentáre

PL: Zasilacz w komplecie

CZ: Napájení je součástí dodávky

SK: Napájanie je súčasťou dodávky

EN: Power supply included

ARCHITEKTONICZNE LAMPY LED

CZ: LED svítidlo/ SK: LED svetidlo/ EN: LED lamp



INDEX	ABC			Tc[K]		A [mm]	B [mm]	C [mm]	
013674	Kras LED	9 W	546 lm	4000 K	Czarny Černá Čierny Black	157	176	204	5902808804345

AC 230V	SMD LED	120°	NON-DIM
CRI(Ra)	40000 h	IP54	IN&OUT
PIR			

Materiał / Materiał / Material

PL: Stal nierdzewna

CZ: Korozivzdorná ocel

SK: Nehrdzavejúca oceľ

EN: Stainless steel

Uwagi / Komentář / Komentáre

PL: Zasilacz w komplecie

CZ: Napájení je součástí dodávky

SK: Napájanie je súčasťou dodávky

EN: Power supply included

PRATO



ARCHITEKTONICZNE LAMPY LED

CZ: LED svítidlo/ SK: LED svetidlo/ EN: LED lamp



INDEX	ABC			Tc[K]		A [mm]	B [mm]	C [mm]	
013675	Prato LED	9 W	680	4000 K	Czarny Černá Čierny Black	69	47	235	5902808804352

AC 230V	SMD LED		NON-DIM
CRI(Ra)	40000 h	54	IN&OUT
PIR			

Materiał / Materiał / Material

PL: aluminium

CZ: hliník

SK: hliník

EN: aluminium

Uwagi / Komentář / Komentáre

PL: Zasilacz w komplecie

CZ: Napájení je součástí dodávky

SK: Napájanie je súčasťou dodávky

EN: Power supply included

Brolux

www.bowi.com.pl

ARCHITEKTONICZNE LAMPY LED

CZ: LED svítidlo / SK: LED svetidlo / EN: LED lamp



INDEX	ABC			Tc[K]		A [mm]	B [mm]	C [mm]	
013704	CARRI LED	6 W		4000 K	Antracytowy RAL 7016 antracitová RAL 7016 antracitová RAL 7016 anthracite RAL 7016	160	90	160	5902808805342

AC 230V	SMD LED		NON-DIM
CRI(Ra)	40000 h	54	IN&OUT
PIR			

Materiał / Materiál / Material

PL: aluminium

CZ: hliník

SK: hliník

EN: aluminium

Uwagi / Komentář / Komentáre

PL: Zasilacz w komplecie

CZ: Napájení je součástí dodávky

SK: Napájanie je súčasťou dodávky

EN: Power supply included

ARCHITEKTONICZNE LAMPY LED

CZ: Svítidla se snímačem PIR / SK: Svetidlá so snímačom PIR / EN: Lamps with PIR sensor



	INDEX	ABC		Lm	Tc[K]		
A	003636	Laia LED	7 W	230 lm	3500 K	Czarny Černá Čierná Black	5902216721432
B	6506	Oshey LED	7 W	420 lm	3500 K		5902216721456
C	6515	Preston LED	9,5 W	680 lm	3500 K		5902216721463
D	007891	Riston LED	6,5 W	550 lm	3500 K		5902216721470

AC 230V	SMD LED	120°	NON-DIM
CRI/Ra	40000 h	IP	IN&OUT
>80	40000 h	54	IN&OUT

Materiał / Materiał / Material

PL: aluminium

CZ: hliník

SK: hliník

EN: aluminium

Uwagi / Komentář / Komentáre

PL: Zasilacz w komplecie

CZ: Napájení je součástí dodávky

SK: Napájanie je súčasťou dodávky

EN: Power supply included

ARCHITEKTONICZNE LAMPY LED

CZ: Lampy z nerezové oceli / SK: Lámpe z nehrdzavejúcej ocele / EN: Stainless steel lamps



A



B



C



D

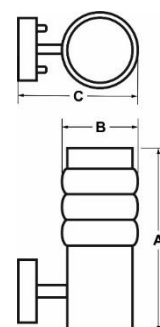

	INDEX			Lm			A [mm]	B [mm]	C [mm]	
A	012813	Lula					330	95	95	5902216798045
B	012814	Lula				Srebrny Sřibrná Sřibrná Silver	230	95	135	5902216798052
C	004815	Yali LED	7 W	300 lm	3500 K		175	220	230	5902216770454
D	003159	Yari LED	7 W	300 lm	3500 K		170	185	220	5902216770430

AC 230V	SMD LED	120°	NON-DIM
CR1/Ra	40000 h	IP 54	IN&OUT

Materiał / Materiál / Material

PL: stalowa nierdzewna

CZ: nerezová ocel

SK: nerezovej ocele

EN: steel plate

Uwagi / Komentář / Komentáre

PL: Zasilacz w komplecie

CZ: Napájení je součástí dodávky

SK: Napájanie je súčasťou dodávky

EN: Power supply included

OPRAWY ELEWACYJNE BEZ ŹRÓDŁA ŚWIATŁA

CZ: Svítidla bez zdroje světla / SK: Svetidlá bez zdroja svetla / EN: Luminaires without a light source



A



B



C



D



E



F



G



H



I



J



K



L



M



N



O



P



R



S



T



U

OPRAWY ŚCIENNE BEZ ŹRÓDŁA ŚWIATŁA

OPRAWY ELEWACYJNE BEZ ŹRÓDŁA ŚWIATŁA

CZ: Svítidla bez zdroje světla / SK: Svetidlá bez zdroja svetla / EN: Luminaires without a light source



INDEX



IP



A	012870	Argon	Biały	GU10		5902216798267
B	012871	Argon	Czarny	GU10		5902216798274
C	012796	Forti	Czarny	GU10	IP54	5902216797871
D	012797	Forti	Srebrny	GU10	IP54	5902216797888
E	012794	Forti	Czarny	GU10	IP54	5902216797895
F	012798	Forti	Srebrny	GU10	IP54	5902216797901
G	5942	Gallun	Czarny	E27	IP54	5902216718968
H	253	Hardin	Czarny	E27	IP54	5902216718975
I	012809	Kiltor	Czarny	GU10	IP54	5902216797918
J	012808	Kiltor	Szary	GU10	IP54	5902216797925
K	012806	Kiltor	Czarny	GU10	IP54	5902216797932
L	012807	Kiltor	Szary	GU10	IP54	5902216797949
M	012805	Kortek	Czarny	GU10	IP54	5902216797956
N	012804	Kortek	Szary	GU10	IP54	5902216797963
O	012802	Kortek	Czarny	GU10	IP54	5902216797970
P	012803	Kortek	Szary	GU10	IP54	5902216797994
R	012800	Korti	Czarny	GU10	IP54	5902216798007
S	012799	Korti	Czarny	GU10	IP54	5902216798014
T	012801	Litek	Czarny	GU10	IP54	5902216798021
U	012795	Litek	Czarny	GU10	IP54	5902216798038



AC 230V



IN&OUT



Materiał / Materiał / Material

PL: aluminium

CZ: hliník

SK: hliník

EN: aluminum



OPRAWY ŚCIENNE BEZ ŹRÓDŁA ŚWIATŁA



OPRAWY ELEWACYJNE BEZ ŹRÓDŁA ŚWIATŁA

CZ: Svítidla bez zdroje světla / SK: Svetidlá bez zdroja svetla / EN: Luminaires without a light source



A



B



C



D



E



F



G



H



I



J



K



L



M



N

Br**o**lux

ARCHITEKTONICZNE LAMPY LED

CZ: Svítidla bez zdroje světla / SK: Svetidlá bez zdroja svetla / EN: Luminaires without a light source



INDEX



IP



A	013025	Litek	Szary	GU10	IP54	5902216799493
B	013026	Litek	Szary	GU10	IP54	5902216799486
C	012813	Lula	Szary	E27	IP54	5902216798045
D	012814	Lula	Szary	E27	IP54	5902216798052
E	6442	Nakita	Czarny	E27	IP54	5902216770225
F	1185	Nalani	Czarny	E27	IP54	5902216719149
G	9119	Neely	Czarny	E27	IP54	5902216719194
H	2035	Niles	Czarny	GU10	IP54	5902216719040
I	013530	Sailor	Czarny	E27	IP54	5902808803331
J	013531	Sailor	Antracytowy	E27	IP54	5902808803348
K	013117	Santa	Czarny	GU10	IP54	5902216799981
L	002585	Welsh	Czarny	E27	IP44	5902216719156
M	002593	Zorin	Czarny	GU10	IP54	5902216719200
N	004826	Zyler	Czarny	E27	IP44	5902216770454



AC 230V



IN&OUT



Materiał / Materiál / Materiál

PL: aluminium

CZ: hliník

SK: hliník

EN: aluminum

OPRAWY ELEWACYJNE BEZ ŹRÓDŁA ŚWIATŁA

CZ: Svítidla bez zdroje světla / SK: Svietidlá bez zdroja svetla / EN: Luminaires without a light source

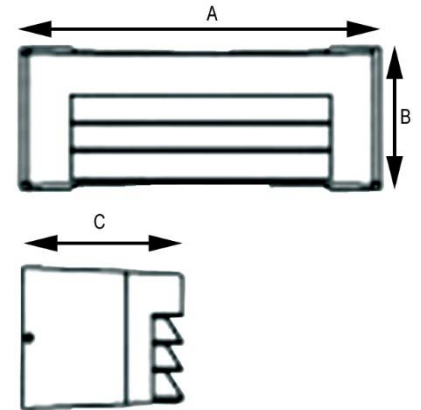

INDEX			A [mm]	B [mm]	C [mm]	
013535	Oliana	Czarny Černá Čierna Black	290	110	130	5902808803539
013536	Oliana	Antracytowy antracitová antracitová anthracite	290	110	130	5902808803546



AC 230V



E27

IP

54



IN&OUT



Materiał / Materiál / Materiál

PL: aluminium

CZ: hliník

SK: hliník

EN: aluminium

Uwagi / Komentář / Komentáre

PL: Zasilacz w komplecie

CZ: Napájení je součástí dodávky

SK: Napájanie je súčasťou dodávky

EN: Power supply included

SURVA



OPRAWY ELEWACYJNE BEZ ŹRÓDŁA ŚWIATŁA

CZ: Svítidla bez zdroje světla / SK: Svietidlá bez zdroja svetla / EN: Luminaires without a light source

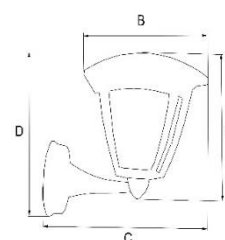

A

B

C

	INDEX	ABC		A [mm]	B [mm]	C [mm]	D [mm]	
A	013078	Surva	Czarny Černá Čierna Black	210	170	215	240	5902216799721
B	013112	Surva		210	170	215	250	5902216799936
C	013685	Surva		210	170	215		5902808804994



AC 230V



E27

IP

44



IN&OUT



Materiał / Materiál / Material

PL: aluminium

CZ: hliník

SK: hliník

EN: aluminium

Uwagi / Komentár / Komentáre

PL: Zasilacz w komplecie

CZ: Napájení je součástí dodávky

SK: Napájanie je súčasťou dodávky

EN: Power supply included

BroLux

ODINA



OPRAWY ELEWACYJNE BEZ ŹRÓDŁA ŚWIATŁA

CZ: Svítidla bez zdroje světla / SK: Svietidlá bez zdroja svetla / EN: Luminaires without a light source

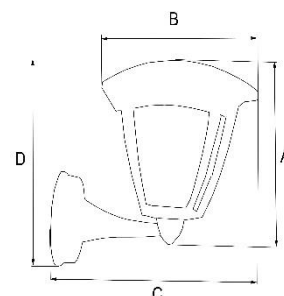

INDEX			A [mm]	B [mm]	C [mm]	D [mm]	
013113	Odina	Czarny Černá Čierna Black	210	170	215	240	5902216799943



AC 230V



E27

IP



IN&OUT



Materiał / Materiál / Material

PL: aluminium

CZ: hliník

SK: hliník

EN: aluminium

Uwagi / Komentář / Komentáre

PL: Zasilacz w komplecie

CZ: Napájení je součástí dodávky

SK: Napájanie je súčasťou dodávky

EN: Power supply included

BroLux

MALIA



OPRAWY ELEWACYJNE BEZ ŹRÓDŁA ŚWIATŁA

CZ: Svítidla bez zdroje světla / SK: Svetidlá bez zdroja svetla / EN: Luminaires without a light source

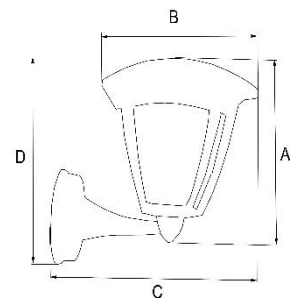

INDEX			A [mm]	B [mm]	C [mm]	D [mm]	
013114	Malia	Czarny Černá Čierna Black	210	175	215	240	5902216799950



AC 230V



E27

IP



IN&OUT



CE

RoHS
COMPLIANT

Materiał / Materiál / Material

PL: aluminium

CZ: hliník

SK: hliník

EN: aluminium

Uwagi / Komentář / Komentáre

PL: Zasilacz w komplecie

CZ: Napájení je součástí dodávky

SK: Napájanie je súčasťou dodávky

EN: Power supply included

BroLux

OPRAWY ELEWACYJNE BEZ ŹRÓDŁA ŚWIATŁA

CZ: Svítidla bez zdroje světla / SK: Svietidlá bez zdroja svetla / EN: Luminaires without a light source

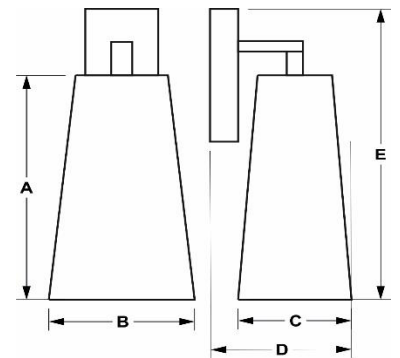

INDEX	ABC		A [mm]	B [mm]	C [mm]	D [mm]	E [mm]	
013115	Rina		293	170	140	165	310	5902216799967



AC 230V



E27

IP



IN&OUT



CE

RoHS
COMPLIANT

Materiał / Materiál / Material

PL: aluminium

CZ: hliník

SK: hliník

EN: aluminium

Uwagi / Komentár / Komentáre

PL: Zasilacz w komplecie

CZ: Napájení je součástí dodávky

SK: Napájanie je súčasťou dodávky

EN: Power supply included

OPRAWY ELEWACYJNE BEZ ŹRÓDŁA ŚWIATŁA

CZ: Svítidla bez zdroje světla / SK: Svietidlá bez zdroja svetla / EN: Luminaires without a light source

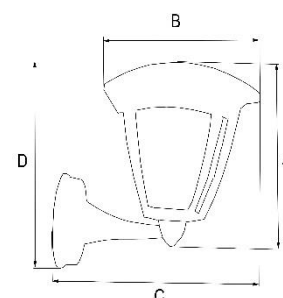

INDEX	ABC		A [mm]	B [mm]	C [mm]	D [mm]	
013116	Wilda	Czarny Černá Čierná Black	260	210	250	260	5902216799974



AC 230V



E27

IP



IN&OUT



CE

RoHS
COMPLIANT

Materiał / Materiál / Material

PL: aluminium

CZ: hliník

SK: hliník

EN: aluminium

Uwagi / Komentář / Komentáre

PL: Zasilacz w komplecie

CZ: Napájení je součástí dodávky

SK: Napájanie je súčasťou dodávky

EN: Power supply included

OPRAWY ELEWACYJNE BEZ ŹRÓDŁA ŚWIATŁA

CZ: Svítidla bez zdroje světla / SK: Svietidlá bez zdroja svetla / EN: Luminaires without a light source

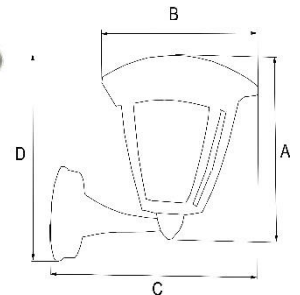

INDEX			A [mm]	B [mm]	 C [mm]	D [mm]	
013118	ELENI	Czarny Černá Čierna Black	180	240	260	165	5902216799974



AC 230V



E27

IP



IN&OUT



Materiał / Materiál / Material

PL: aluminium

CZ: hliník

SK: hliník

EN: aluminium

Uwagi / Komentár / Komentáre

PL: Zasilacz w komplecie

CZ: Napájení je součástí dodávky

SK: Napájanie je súčasťou dodávky

EN: Power supply included

BroLux

OPRAWY ELEWACYJNE BEZ ŹRÓDŁA ŚWIATŁA

CZ: Svítidla bez zdroje světla / SK: Svetidlá bez zdroja svetla / EN: Luminaires without a light source

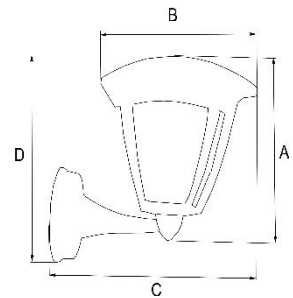

INDEX			A [mm]	B [mm]	C [mm]	D [mm]	
013583	ADDA	Czarny Černá Čierná Black	210	210	250	210	5902808804840



AC 230V



E27

IP



IN&OUT



Materiał / Materiál / Material

PL: aluminium

CZ: hliník

SK: hliník

EN: aluminium

Uwagi / Komentář / Komentáre

PL: Zasilacz w komplecie

CZ: Napájení je součástí dodávky

SK: Napájanie je súčasťou dodávky

EN: Power supply included

OPRAWY ELEWACYJNE BEZ ŹRÓDŁA ŚWIATŁA

CZ: Svítidla bez zdroje světla / SK: Svetidlá bez zdroja svetla / EN: Luminaires without a light source

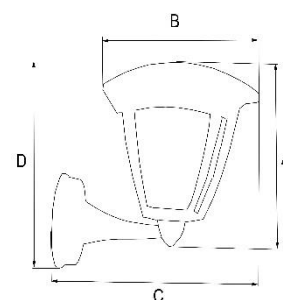

INDEX			A [mm]	B [mm]	 C [mm]	D [mm]	
013584	BARD	Czarny Černá Čierná Black	235	305	370	350	5902808804857



AC 230V



E27

IP



IN&OUT



Materiał / Materiál / Material

PL: aluminium

CZ: hliník

SK: hliník

EN: aluminium

Uwagi / Komentář / Komentáre

PL: Zasilacz w komplecie

CZ: Napájení je součástí dodávky

SK: Napájanie je súčasťou dodávky

EN: Power supply included

OPRAWY ELEWACYJNE BEZ ŹRÓDŁA ŚWIATŁA

CZ: Svítidla bez zdroje světla / SK: Svetidlá bez zdroja svetla / EN: Luminaires without a light source

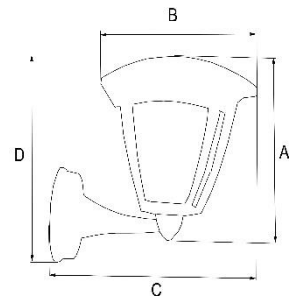

INDEX			A [mm]	B [mm]	C [mm]	D [mm]	
013588	NILDA	Czarny Černá Čierná Black	290	250	365	400	5902808804840



AC 230V



E27

IP



IN&OUT



Materiał / Materiál / Material

PL: aluminium

CZ: hliník

SK: hliník

EN: aluminium

Uwagi / Komentář / Komentáre

PL: Zasilacz w komplecie

CZ: Napájení je součástí dodávky

SK: Napájanie je súčasťou dodávky

EN: Power supply included

TAMA



OPRAWY ELEWACYJNE BEZ ŹRÓDŁA ŚWIATŁA

CZ: Svítidla bez zdroje světla / SK: Svetidlá bez zdroja svetla / EN: Luminaires without a light source

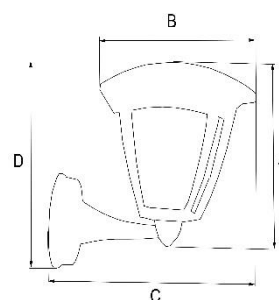

INDEX			A [mm]	B [mm]	C [mm]	D [mm]	
013590	TAMA	Czarny Černá Čierna Black	260	185	285	380	5902808804949



AC 230V



E27

IP



IN&OUT



Materiał / Materiál / Material

PL: aluminium

CZ: hliník

SK: hliník

EN: aluminium

Uwagi / Komentář / Komentáre

PL: Zasilacz w komplecie

CZ: Napájení je součástí dodávky

SK: Napájanie je súčasťou dodávky

EN: Power supply included

Brolux

ULAN



OPRAWY ELEWACYJNE BEZ ŹRÓDŁA ŚWIATŁA

CZ: Svítidla bez zdroje světla / SK: Svietidlá bez zdroja svetla / EN: Luminaires without a light source

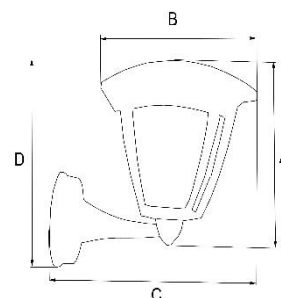

INDEX			A [mm]	B [mm]	C [mm]	D [mm]	
013593	ULAN	Czarny Černá Čierná Black	305	180	240	320	5902808804963



AC 230V



E27

IP



IN&OUT



Materiał / Materiál / Materiál

PL: aluminium

CZ: hliník

SK: hliník

EN: aluminium

Uwagi / Komentář / Komentáre

PL: Zasilacz w komplecie

CZ: Napájení je součástí dodávky

SK: Napájanie je súčasťou dodávky

EN: Power supply included

Brolux

ZUNA



OPRAWY ELEWACYJNE BEZ ŹRÓDŁA ŚWIATŁA

CZ: Svítidla bez zdroje světla / SK: Svetidlá bez zdroja svetla / EN: Luminaires without a light source

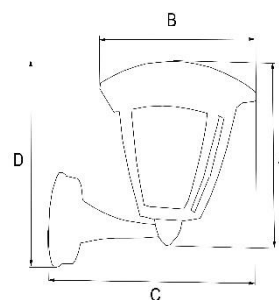

INDEX	ABC		A [mm]	B [mm]	C [mm]	D [mm]	
013582	ZUNA		235	280	385	325	5902808804987



AC 230V



E27

IP



IN&OUT



Materiał / Materiál / Materiál

PL: aluminium

CZ: hliník

SK: hliník

EN: aluminium

Uwagi / Komentář / Komentáre

PL: Zasilacz w komplecie

CZ: Napájení je součástí dodávky

SK: Napájanie je súčasťou dodávky

EN: Power supply included

Brolux

EDINA



OPRAWY ELEWACYJNE BEZ ŹRÓDŁA ŚWIATŁA

CZ: Svítidla bez zdroje světla / SK: Svetidlá bez zdroja svetla / EN: Luminaires without a light source

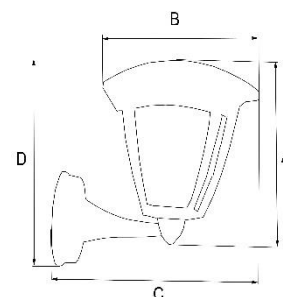

INDEX			A [mm]	B [mm]	C [mm]	D [mm]	
013595	EDINA	Czarny Černá Čierna Black	205	195	235	215	5902808804864



AC 230V



E27

IP



IN&OUT



Materiał / Materiál / Material

PL: aluminium

CZ: hliník

SK: hliník

EN: aluminium

Uwagi / Komentář / Komentáre

PL: Zasilacz w komplecie

CZ: Napájení je součástí dodávky

SK: Napájanie je súčasťou dodávky

EN: Power supply included

BroLux

ELGIN



OPRAWY ELEWACYJNE BEZ ŹRÓDŁA ŚWIATŁA

CZ: Svítidla bez zdroje světla / SK: Svietidlá bez zdroja svetla / EN: Luminaires without a light source

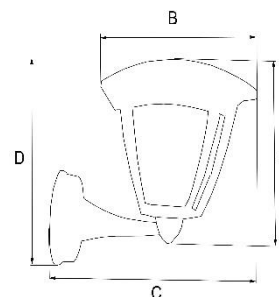

INDEX			A [mm]	B [mm]	 C [mm]	D [mm]	
013596	ELGIN	Czarny Černá Čierná Black	207	195	235	210	5902808804871



AC 230V



E27

IP



IN&OUT



CE

RoHS
COMPLIANT

Materiał / Materiál / Materiál

PL: aluminium

CZ: hliník

SK: hliník

EN: aluminium

Uwagi / Komentář / Komentáre

PL: Zasilacz w komplecie

CZ: Napájení je součástí dodávky

SK: Napájanie je súčasťou dodávky

EN: Power supply included

Brulux

OPRAWY ELEWACYJNE BEZ ŹRÓDŁA ŚWIATŁA

CZ: Svítidla bez zdroje světla / SK: Svetidlá bez zdroja svetla / EN: Luminaires without a light source

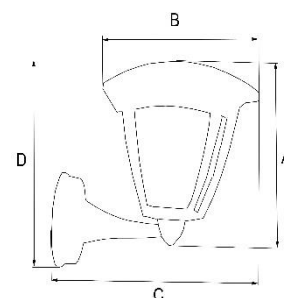

INDEX			A [mm]	B [mm]	C [mm]	D [mm]	
013594	ZALIKA	Czarny Černá Čierná Black	178	240	260	182	5902808804970



AC 230V



E27

IP



IN&OUT



Materiał / Materiál / Material

PL: aluminium

CZ: hliník

SK: hliník

EN: aluminium

Uwagi / Komentář / Komentáre

PL: Zasilacz w komplecie

CZ: Napájení je součástí dodávky

SK: Napájanie je súčasťou dodávky

EN: Power supply included

FAYOLA



OPRAWY ELEWACYJNE BEZ ŹRÓDŁA ŚWIATŁA

CZ: Svítidla bez zdroje světla / SK: Svetidlá bez zdroja svetla / EN: Luminaires without a light source

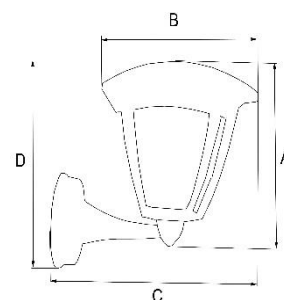

INDEX			A [mm]	B [mm]	C [mm]	D [mm]	
013597	FAYOLA	Czarny Černá Čierná Black	170	178	201	185	5902808804888



AC 230V



E27

IP



IN&OUT



Materiał / Materiál / Material

PL: aluminium

CZ: hliník

SK: hliník

EN: aluminium

Uwagi / Komentář / Komentáre

PL: Zasilacz w komplecie

CZ: Napájení je součástí dodávky

SK: Napájanie je súčasťou dodávky

EN: Power supply included

BroLux

OPRAWY ELEWACYJNE BEZ ŹRÓDŁA ŚWIATŁA

CZ: Svítidla bez zdroje světla / SK: Svetidlá bez zdroja svetla / EN: Luminaires without a light source

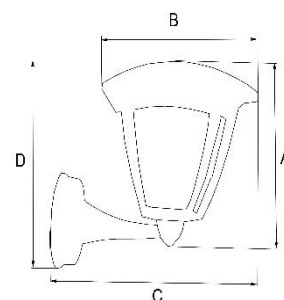

INDEX			A [mm]	B [mm]	C [mm]	D [mm]	
013597	GALINI	Czarny Černá Čierná Black	167	178	201	182	5902808804888



AC 230V



E27

IP



IN&OUT



Materiał / Materiál / Material

PL: aluminium

CZ: hliník

SK: hliník

EN: aluminium

Uwagi / Komentář / Komentáre

PL: Zasilacz w komplecie

CZ: Napájení je součástí dodávky

SK: Napájanie je súčasťou dodávky

EN: Power supply included

LAVINA



OPRAWY ELEWACYJNE BEZ ŹRÓDŁA ŚWIATŁA

CZ: Svítidla bez zdroje světla / SK: Svietidlá bez zdroja svetla / EN: Luminaires without a light source

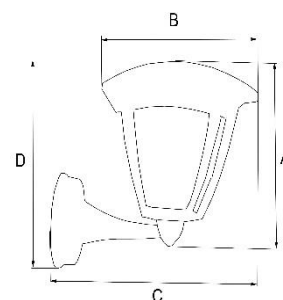

INDEX	ABC		A [mm]	B [mm]	C [mm]	D [mm]	
013597	LAVINA	Czarny Černá Čierná Black	220	195	235	300	5902808804888



AC 230V



E27

IP



IN&OUT



Materiał / Materiál / Material

PL: aluminium

CZ: hliník

SK: hliník

EN: aluminium

Uwagi / Komentář / Komentáre

PL: Zasilacz w komplecie

CZ: Napájení je součástí dodávky

SK: Napájanie je súčasťou dodávky

EN: Power supply included

BroLux

LEILA



OPRAWY ELEWACYJNE BEZ ŹRÓDŁA ŚWIATŁA

CZ: Svítidla bez zdroje světla / SK: Svetidlá bez zdroja svetla / EN: Luminaires without a light source

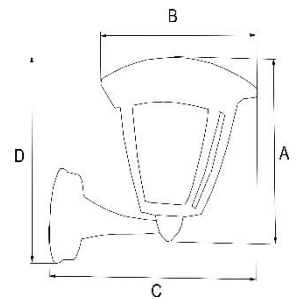

INDEX			A [mm]	B [mm]	C [mm]	D [mm]	
013587	LEILA	Czarny Černá Čierná Black	230	240	278	303	5902808804918



AC 230V



E27

IP



IN&OUT



Materiał / Materiál / Material

PL: aluminium

CZ: hliník

SK: hliník

EN: aluminium

Uwagi / Komentár / Komentáre

PL: Zasilacz w komplecie

CZ: Napájení je součástí dodávky

SK: Napájanie je súčasťou dodávky

EN: Power supply included

Brolux

TALISA



OPRAWY ELEWACYJNE BEZ ŹRÓDŁA ŚWIATŁA

CZ: Svítidla bez zdroje světla / SK: Svietidlá bez zdroja svetla / EN: Luminaires without a light source

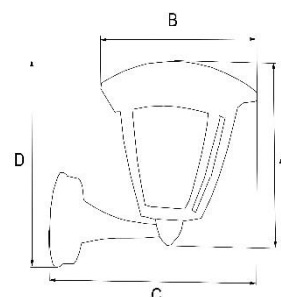

INDEX			A [mm]	B [mm]	C [mm]	D [mm]	
013591	TALISA	Czarny Černá Čierná Black	260	250	330	370	5902808804932



AC 230V



E27

IP



IN&OUT



Materiał / Materiál / Material

PL: aluminium

CZ: hliník

SK: hliník

EN: aluminium

Uwagi / Komentář / Komentáre

PL: Zasilacz w komplecie

CZ: Napájení je součástí dodávky

SK: Napájanie je súčasťou dodávky

EN: Power supply included

BroLux

TANGIA



OPRAWY ELEWACYJNE BEZ ŹRÓDŁA ŚWIATŁA

CZ: Svítidla bez zdroje světla / SK: Svetidlá bez zdroja svetla / EN: Luminaires without a light source

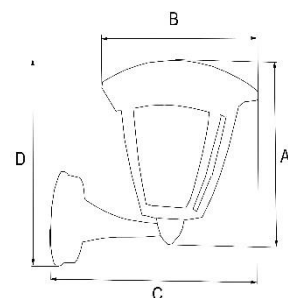

INDEX			A [mm]	B [mm]	 C [mm]	D [mm]	
013592	TANGIA	Czarny Černá Čierna Black	260	250	425	360	5902808804956



AC 230V



E27

IP



IN&OUT



CE

RoHS
COMPLIANT

Materiał / Materiál / Material

PL: aluminium

CZ: hliník

SK: hliník

EN: aluminium

Uwagi / Komentář / Komentáre

PL: Zasilacz w komplecie

CZ: Napájení je součástí dodávky

SK: Napájanie je súčasťou dodávky

EN: Power supply included

BroLux

OPRAWY ELEWACYJNE BEZ ŹRÓDŁA ŚWIATŁA

CZ: Svítidla bez zdroje světla / SK: Svetidlá bez zdroja svetla / EN: Luminaires without a light source

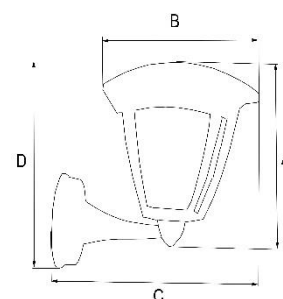

INDEX	ABC		A [mm]	B [mm]	C [mm]	
006951	Karego	Czarny Černá Čierná Black	215	150	365	5902808804123



AC 230V



E27

IP

44



IN&OUT



Materiał / Materiál / Material

PL: aluminium

CZ: hliník

SK: hliník

EN: aluminium

OPRAWY ELEWACYJNE BEZ ŹRÓDŁA ŚWIATŁA

CZ: Svítidla bez zdroje světla / SK: Svietidlá bez zdroja svetla / EN: Luminaires without a light source



INDEX	ABC		A [mm]	B [mm]	C [mm]	
013603	Nalani	Antracytowy RAL 7016 antracitová RAL 7016 antracitová RAL 7016 anthracite RAL 7016	110	120	342	5902808804130
1185	Nalani	Czarny Černá Čierná Black	110	120	342	5902216719149



AC 230V



E27



54



IN&OUT



Materiał / Materiál / Material

PL: aluminium

CZ: hliník

SK: hliník

EN: aluminium

Uwagi / Komentář / Komentáre

PL: Zasilacz w komplecie

CZ: Napájení je součástí dodávky

SK: Napájanie je súčasťou dodávky

EN: Power supply included

NEELY



OPRAWY ELEWACYJNE BEZ ŹRÓDŁA ŚWIATŁA

CZ: Svítidla bez zdroje světla / SK: Svetidlá bez zdroja svetla / EN: Luminaires without a light source



INDEX	ABC		A [mm]	B [mm]	C [mm]	
013604	Neely	Antracytowy RAL 7016 antracitová RAL 7016 antracitová RAL 7016 anthracite RAL 7016	260	125	125	5902808804147



AC 230V



E27



54



IN&OUT



RoHS
COMPLIANT

Materiał / Materiał / Material

PL: aluminium

CZ: hliník

SK: hliník

EN: aluminium

Uwagi / Komentář / Komentáre

PL: Zasilacz w komplecie

CZ: Napájení je součástí dodávky

SK: Napájanie je súčasťou dodávky

EN: Power supply included

Brolux

www.bowi.com.pl

KETOR



OPRAWY ELEWACYJNE BEZ ŹRÓDŁA ŚWIATŁA

CZ: Svítidla bez zdroje světla / SK: Svetidlá bez zdroja svetla / EN: Luminaires without a light source



INDEX	ABC		A [mm]	B [mm]	C [mm]	
013668	Ketor		118	68	150	5902808804406

		IP	
AC 230V	GU10	44	IN&OUT
PIR			

Materiał / Materiál / Material

PL: aluminium

CZ: hliník

SK: hliník

EN: aluminium

Br^olux

www.bowi.com.pl

OPRAWY ELEWACYJNE BEZ ŹRÓDŁA ŚWIATŁA

CZ: Svítidla bez zdroje světla / SK: Svetidlá bez zdroja svetla / EN: Luminaires without a light source



INDEX	ABC		A [mm]	B [mm]	C [mm]	
013671	Nordi	Czarny Černá Čierná Black	95	66	100	5902808804413

		IP	
AC 230V	GU10	54	IN&OUT

Materiał / Materiál / Material

PL: aluminium

CZ: hliník

SK: hliník

EN: aluminium

OPRAWY ELEWACYJNE BEZ ŹRÓDŁA ŚWIATŁA

CZ: Svítidla bez zdroje světla / SK: Svetidlá bez zdroja svetla / EN: Luminaires without a light source



INDEX	ABC		A [mm]	B [mm]	C [mm]	
013676	Oriko	Czarny Černá Čierná Black	270	182	120	5902808804420

		IP	
AC 230V	E27	54	IN&OUT
PIR			

Materiał / Materiál / Material

PL: aluminium

CZ: hliník

SK: hliník

EN: aluminium

REVOR



OPRAWY ELEWACYJNE BEZ ŹRÓDŁA ŚWIATŁA

CZ: Svítidla bez zdroje světla / SK: Svetidlá bez zdroja svetla / EN: Luminaires without a light source



INDEX	ABC		A [mm]	B [mm]	C [mm]	
013665	Revor	Czarny Černá Čierná Black	118	68	150	5902808804437

		IP	
AC 230V	GU10	54	IN&OUT
		CE	
	PIR		

Materiał / Materiál / Material

PL: aluminium

CZ: hliník

SK: hliník

EN: aluminium

Br^olux

www.bowi.com.pl

FREON



OPRAWY ELEWACYJNE BEZ ŹRÓDŁA ŚWIATŁA

CZ: Svítidla bez zdroje světla / SK: Svetidlá bez zdroja svetla / EN: Luminaires without a light source

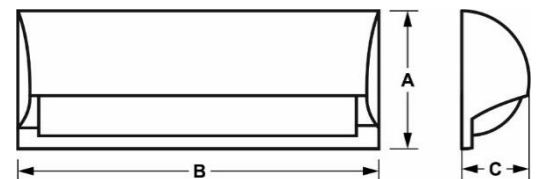

INDEX	ABC		A [mm]	B [mm]	C [mm]	
006946	Freon		125	250	114	5902808804109
012862	Freon		125	250	114	5902808804116
012869	Freon		125	250	114	5902216798243



AC 230V



E27

IP

54



IN&OUT



Materiał / Materiál / Material

PL: aluminium

CZ: hliník

SK: hliník

EN: aluminium

Brolux

www.bowi.com.pl

OPRAWY ELEWACYJNE BEZ ŹRÓDŁA ŚWIATŁA

CZ: Svítidla bez zdroje světla / SK: Svetidlá bez zdroja svetla / EN: Luminaires without a light source



INDEX			A [mm]	B [mm]	C [mm]	
013306	ORINS	Czarny Černá Čierna Black	141	90	180	5902808804635



AC 230V



E27

IP

44



IN&OUT



Materiał / Materiál / Material

PL: aluminium

CZ: hliník

SK: hliník

EN: aluminium

Uwagi / Komentár / Komentáre

PL: Zasilacz w komplecie

CZ: Napájení je součástí dodávky

SK: Napájanie je súčasťou dodávky

EN: Power supply included

OPRAWY ELEWACYJNE BEZ ŹRÓDŁA ŚWIATŁA

CZ: Svítidla bez zdroje světla / SK: Svietidlá bez zdroja svetla / EN: Luminaires without a light source



INDEX	ABC →		A [mm]	B [mm]	C [mm]	
002217	ZOE	Antracytowy RAL 7016 antracitová RAL 7016 antracitová RAL 7016 anthracite RAL 7016	125	125	260	5902808805397



AC 230V



E27

IP



IN&OUT



Materiał / Materiál / Materiál

PL: aluminium

CZ: hliník

SK: hliník

EN: aluminium

Uwagi / Komentář / Komentáre

PL: Zasilacz w komplecie

CZ: Napájení je součástí dodávky

SK: Napájanie je súčasťou dodávky

EN: Power supply included

OPRAWY ELEWACYJNE BEZ ŹRÓDŁA ŚWIATŁA

CZ: Svítidla bez zdroje světla / SK: Svietidlá bez zdroja svetla / EN: Luminaires without a light source



INDEX			A [mm]	B [mm]	C [mm]	
008945	ARAGO	Antracytowy RAL 7016 antracitová RAL 7016 antracitová RAL 7016 anthracite RAL 7016	145	70	240	5902216730793

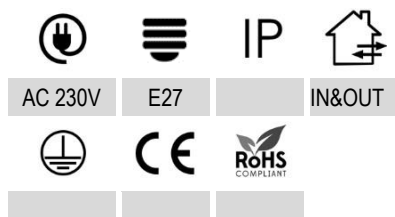

Materiał / Materiál / Material

PL: aluminium
 CZ: hliník
 SK: hliník
 EN: aluminium

Uwagi / Komentár / Komentáre

PL: Zasilacz w komplecie
 CZ: Napájení je součástí dodávky
 SK: Napájanie je súčasťou dodávky
 EN: Power supply included

ARIANA



OPRAWY ELEWACYJNE BEZ ŹRÓDŁA ŚWIATŁA

CZ: Svítidla bez zdroje světla / SK: Svietidlá bez zdroja svetla / EN: Luminaires without a light source



INDEX	ABC		A [mm]	B [mm]	C [mm]	
007044	ARIANA		160	190	160	5902808805380



AC 230V



E27

IP



IN&OUT



Materiał / Materiál / Materiál

PL: aluminium

CZ: hliník

SK: hliník

EN: aluminium

Uwagi / Komentár / Komentáre

PL: Zasilacz w komplecie

CZ: Napájení je součástí dodávky

SK: Napájanie je súčasťou dodávky

EN: Power supply included

Brolux

OPRAWY ELEWACYJNE BEZ ŹRÓDŁA ŚWIATŁA

CZ: Svítidla bez zdroje světla / SK: Svietidlá bez zdroja svetla / EN: Luminaires without a light source



INDEX			A [mm]	B [mm]	C [mm]	
002426	BRETT		260	105	125	5902216722262

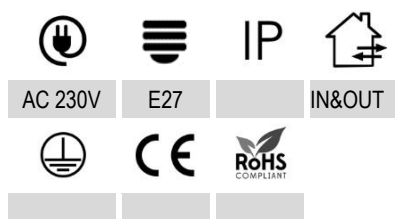

Materiał / Materiál / Materiál

PL: aluminium

CZ: hliník

SK: hliník

EN: aluminium

Uwagi / Komentár / Komentáre

PL: Zasilacz w komplecie

CZ: Napájení je součástí dodávky

SK: Napájanie je súčasťou dodávky

EN: Power supply included

FALIN



OPRAWY ELEWACYJNE BEZ ŹRÓDŁA ŚWIATŁA







CZ: Svítidla bez zdroje světla / SK: Svietidlá bez zdroja svetla / EN: Luminaires without a light source



A



B

		INDEX						
					A [mm]	B [mm]	C [mm]	
A	013708	FALIN	Antracytowy RAL 7016 antracitová RAL 7016 antracitová RAL 7016 anthracite RAL 7016		220	104	130	5902216722262
B	1310	FALIN	Czarny Černá Čierna Black		220	104	130	5902216771093



AC 230V



E27



IP



IN&OUT



Materiał / Materiál / Material

PL: aluminium

CZ: hliník

SK: hliník

EN: aluminium

Uwagi / Komentár / Komentáre

PL: Zasilacz w komplecie

CZ: Napájení je součástí dodávky

SK: Napájanie je súčasťou dodávky

EN: Power supply included

Brolux

PETUNIA



OPRAWY ELEWACYJNE BEZ ŹRÓDŁA ŚWIATŁA

CZ: Svítidla bez zdroje světla / SK: Svietidlá bez zdroja svetla / EN: Luminaires without a light source



INDEX	ABC		A [mm]	B [mm]	C [mm]	
009148	PETUNIA		160	190	160	5902808805410

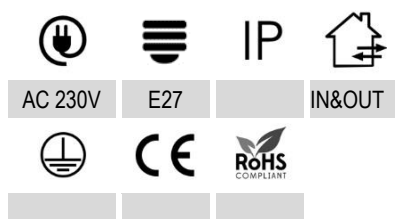

Materiał / Materiál / Materiál

PL: aluminium

CZ: hliník

SK: hliník

EN: aluminium

Uwagi / Komentár / Komentáre

PL: Zasilacz w komplecie

CZ: Napájení je součástí dodávky

SK: Napájanie je súčasťou dodávky

EN: Power supply included



OPRAWY SOLARNE

CZ: Solární svítidla / SK: Slnéčné svietidlá / EN: Solar luminaires



INDEX						
6451	Amas LED	2,5 W	200 lm	3500 K	Czarny Černá Čierna Black	5902216789746

AC 230V	SMD LED	120°	NON-DIM
CRI/Ra		IP	
>80	50000 h	54	IN&OUT

Materiał / Materiál / Material

PL: aluminium

CZ: hliník

SK: hliník

EN: aluminium

Uwagi / Komentář / Komentáre

PL: Zasilacz w komplecie

CZ: Napájení je součástí dodávky

SK: Napájanie je súčasťou dodávky

EN: Power supply included

PALESA



OPRAWY SOLARNE

CZ: Solární svítidla/ SK: Slnéčné svietidlá/ EN: Solar luminaires



	A	B								A [mm]	B [mm]	C [mm]	
A	013526	PALESA LED	1 W	SMD LED	75 lm	Microvawe	4000 K	Czarny	231	83	89	5902808803294	
	013528	PALESA LED	1 W	COB	35 lm		4000 K	Černá	231	83	89	5902808803317	
								Black					
B	013527	PALESA LED	1 W	SMD LED	75 lm	Microvawe	4000 K	Szary	231	83	89	5902808803300	
	013529	PALESA LED	1 W	COB	35 lm		4000 K	Šedá	231	83	89	5902808803324	
								Grey					

AC 230V	60°	NON-DIM	IN&OUT
>80	50000 h	65	

Materiał / Materiál / Material

PL: ABS
 CZ: ABS
 SK: ABS
 EN: ABS

Uwagi / Komentář / Komentáre

PL: Akumulator 3,7V 1800mA
 CZ: Akumulátor 3,7V 1800mA
 SK: Akumulátor 3,7V 1800mA
 EN: Battery 3,7V 1800mA

Uwagi / Komentář / Komentáre

PL: Po zmierzchu oprawa z czujnikiem ruchu zapala się na 100% jasności przy wykryciu ruchu, a po 10s bez wykrycia ruchu przygasa na 50%. Oprawa bez czujnika ruchu zapala się na 100% jasności. Za dnia oprawa nie zapala się
 CZ: Po setmění se svítidlo se snímačem pohybu rozsvítí při detekci pohybu na 100% jas a po 10 s bez detekce pohybu se ztlumí o 50%. Svítidlo bez snímače pohybu se rozsvítí na 100% jas. Svítidlo se nerozsvítí během dne
 SK: Po súmraku sa svietidlo so snímačom pohybu pri detekcii pohybu rozsvieti na 100% jas a po 10 s bez detekcie pohybu sa stlmí o 50%. Svietidlo bez snímača pohybu sa rozsvieti na 100% jas. Svietidlo sa počas dňa nerozsvieti
 EN: After dusk, the luminaire with a motion sensor lights up with 100% brightness when motion is detected, and after 10s without motion detection, it dims by 50%. The luminaire without a motion sensor lights up at 100% brightness. The luminaire does not light up during the day



SŁUPKI LED

CZ: LED Sloupky / SK: LED stĺpiky / EN: LED posts



	INDEX			Lm	Tc[K]		A [mm]	
A	013700	Tolard LED	12 W	1000-2000 lm	4000 K	Czarny Černá Čierná Black	800	5902808805007
B	013701	Tolard LED	15W	1000-2000 lm	4000 K		1200	5902808805014
C	013699	Tolard LED	36 W	2001-5000 lm	4000 K		2500	5902808805021



AC 230V

SMD LED

NON-DIM

IN&OUT



80

40000 h

44



Materiał / Materiał / Material

PL: aluminium

CZ: hliník

SK: hliník

EN: aluminium

Uwagi / Komentář / Komentáre

PL: Zasilacz w komplecie

CZ: Napájení je součástí dodávky

SK: Napájanie je súčasťou dodávky

EN: Power supply included

KASPIANUS



SŁUPKI LED

CZ: LED Sloupky / SK: LED stĺpiky / EN: LED posts



INDEX				Tc[K]		A [mm]	B [mm]	
007472	Kaspianus LED	13 W		3000 K	Czarny Černá Čierná Black	135	500	5902216719842



AC 230V



SMD LED



NON-DIM



IN&OUT



80



40000 h



54



Materiał / Materiał / Material

PL: aluminium

CZ: hliník

SK: hliník

EN: aluminium

Uwagi / Komentář / Komentáre

PL: Zasilacz w komplecie

CZ: Napájení je součástí dodávky

SK: Napájanie je súčasťou dodávky

EN: Power supply included

Brolux

PLESA



SŁUPKI LED

CZ: LED Sloupky / SK: LED stĺpiky / EN: LED posts



INDEX				Tc[K]		A [mm]	B [mm]	
006949	Plesa LED	7 W		3000 K	Czarny Černá Čierná Black	70	500	5902808804659



AC 230V SMD LED NON-DIM IN&OUT



80 40000 h 54



Materiał / Materiál / Material

PL: aluminium

CZ: hliník

SK: hliník

EN: aluminium

Uwagi / Komentář / Komentáre

PL: Zasilacz w komplecie

CZ: Napájení je součástí dodávky

SK: Napájanie je súčasťou dodávky

EN: Power supply included

Brolux

SŁUPKI LED



ARCHITEKTONICZNE LAMPY LED

CZ: LED Sloupky / SK: LED stĺpiky / EN: LED posts



SŁUPKI LED



ARCHITEKTONICZNE LAMPY LED

CZ: LED Sloupky / SK: LED stĺpiky / EN: LED posts



INDEX



IP



HEIGHT



A	000975	Ayron LED	6,5 W	420 lm	3500 K		40°	IP54	SMD LED	800mm	5902216771079
B	002221	Cailin LED	1*7 W	370 lm	4500 K		50°	IP65	Power LED	400mm	5902216770980
C	002243	Camee LED	3*1 W	120 lm	4500 K		60°	IP54	Power LED	720×120 mm	5902216770966
D	004979	Dawson LED	6,5 W	420 lm	3500 K		40°	IP54	SMD LED	150×60×500 mm	5902216789692
E	001932	Halen LED	6*2 W	300 lm	4500 K		120°	IP54	Power LED	Ø130×600 mm	5902216770829
F	000187	Idan LED	1*7 W	340 lm	4500 K		100°	IP54	Power LED	Ø210×650 mm	5902216770812
G	002825	Ikira LED	7 W	560 lm	3500 K		50°	IP54	SMD LED	260×430×260 mm	5902216721487
H	003198	Laima LED	6 W	420 lm	3500 K		100°	IP54	SMD LED	156×600×138 mm	5902216770751
I	275	Malin LED	6 W	480 lm	3500 K		120°	IP54	Power LED	600×200 mm	5902216770683
J	002805	Onica LED	6 W	420 lm	3500 K		120°	IP54	SMD LED	75×570×151 mm	5902216770652
K	367	Orik LED	4 W	800 lm	3500 K		120°	IP54	SMD LED	190×68 mm	5902216719057
L	002657	Salsa LED	6 W	540 lm	3500 K		120°	IP54	SMD LED	500 mm	5902216719620
M	6333	Sanam LED	6 W	540 lm	3500 K		120°	IP54	SMD LED	300 mm	5902216719583
N	5749	Sanam LED	6 W	520 lm	3500 K		120°	IP54	SMD LED	500 mm	5902216719590
O	005269	Sanam LED	6 W	540 lm	3500 K		120°	IP54	SMD LED	800mm	5902216719637
P	005141	Sanders LED	6 W	520 lm	3500 K		120°	IP54	SMD LED	500 mm	5902216717039
Q	6325	Sandie LED	6 W	520 lm	3500 K		120°	IP54	SMD LED	500 mm	5902216717022
R	5745	Sandor LED	6 W	520 lm	3500 K		120°	IP54	SMD LED	500 mm	5902216770577
S	1342	Santon LED	6 W	520 lm	3500 K		50°	IP54	SMD LED	500 mm	5902216789739
T	5978	Saven LED	6 W	520 lm	3500 K		120°	IP54	SMD LED	500 mm	5902216717046
U	5742	Savio LED	6 W	520 lm	3500 K		120°	IP54	SMD LED	800 mm	5902216770560
V	3519	Sedge LED	6 W	670 lm	3500 K		50°	IP54	Power LED	300 mm	5902216770515
W	005775	Taryl LED	14×0,5 W	240 lm	3500 K		120°	IP54	Power LED	220×500×145 mm	5902216770485
X	002805	Waels LED	5 W	400 lm	3500 K		120°	IP54	Power LED	108×108 mm	5902216719033
Y	7026	Yanko LED	1×7 W	450 lm	4500 K		50°	IP54	Power LED	Ø90×160 mm	5902216770447
Z	7027	Yogi LED	9,5 W	600 lm	3500 K		120°	IP54	SMD LED	100×1000×102 mm	5902216721494

Czarny
Černá
Čierny
Black



AC 230V



NON-DIM



IN&OUT



80



40000 h



Materiał / Materiál / Material

PL: aluminium

CZ: hliník

SK: hliník

EN: aluminum

Uwagi / Komentář / Komentáre

PL: Zasilacz w komplecie

CZ: Napájení je součástí dodávky

SK: Napájanie je súčasťou dodávky

EN: Power supply included

Brolux

SURVA



SŁUPKI BEZ ŹRÓDŁA ŚWIATŁA

CZ: Lampy z nerezové oceli / SK: Lámp z nehrdzavejúcej ocele / EN: Stainless steel lamps



INDEX	ABC		A [mm]	B [mm]	
5121	Surva	Czarny Černá Čierná Black	170	930	5902808804154

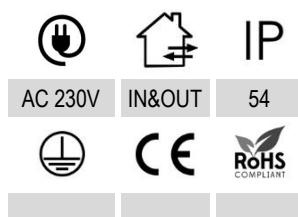

Materiał / Materiál / Material

PL: aluminium

CZ: hliník

SK: hliník

EN: aluminium

Uwagi / Komentář / Komentáre

PL: Zasilacz w komplecie

CZ: Napájení je součástí dodávky

SK: Napájanie je súčasťou dodávky

EN: Power supply included

Brolux

www.bowi.com.pl

KETOR



SŁUPKI BEZ ŹRÓDŁA ŚWIATŁA

CZ: Lampy z nerezové oceli / SK: Lámp z nehrdzavejúcej ocele / EN: Stainless steel lamps



INDEX	ABC		A [mm]	B [mm]	C [mm]	
013669	Ketor	Czarny Černá Čierna Black	70	113	495	5902808804444

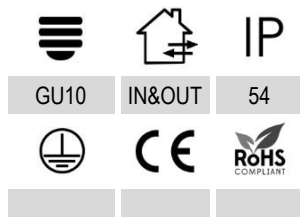

Materiał / Materiál / Material

PL: aluminium

CZ: hliník

SK: hliník

EN: aluminium

Uwagi / Komentář / Komentáre

PL: Zasilacz w komplecie

CZ: Napájení je součástí dodávky

SK: Napájanie je súčasťou dodávky

EN: Power supply included



www.bowi.com.pl





REVOR



SŁUPKI BEZ ŹRÓDŁA ŚWIATŁA

CZ: Lampy z nerezové oceli / SK: Lámp z nehrdzavejúcej oceli / EN: Stainless steel lamps



		INDEX			A [mm]	B [mm]	C [mm]	
A		013666	Revor	Czarny Černá Čierná Black	70	113	495	5902808804451
B		013667	Revor		70	113	800	5902808804468

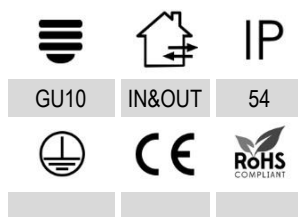

Materiał / Materiál / Material

PL: aluminium

CZ: hliník

SK: hliník

EN: aluminium

Uwagi / Komentář / Komentáre

PL: Zasilacz w komplecie

CZ: Napájení je součástí dodávky

SK: Napájanie je súčasťou dodávky

EN: Power supply included



www.bowi.com.pl

TAVIN



SŁUPKI BEZ ŹRÓDŁA ŚWIATŁA

CZ: Lampy z nerezové oceli / SK: Lámp z nehrdzavejúcej oceli / EN: Stainless steel lamps



	INDEX	ABC		A [mm]	B [mm]	
A	013532	Tavin	Czarny Černá Čierna Black	75	500	5902808803355
B	013533	Tavin	Antracytowy RAL 7016 antracitová RAL 7016 antracitová RAL 7016 anthracite RAL 7016	75	500	5902808803362

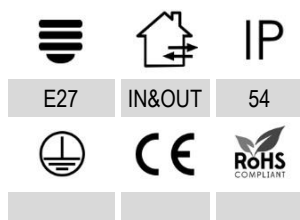

Materiał / Materiál / Material

PL: aluminium

CZ: hliník

SK: hliník

EN: aluminium

Uwagi / Komentář / Komentáre

PL: Zasilacz w komplecie

CZ: Napájení je součástí dodávky

SK: Napájanie je súčasťou dodávky

EN: Power supply included



SŁUPKI BEZ ŹRÓDŁA ŚWIATŁA

CZ: Lampy z nerezové oceli / SK: Lámp z nehrdzavejúcej ocele / EN: Stainless steel lamps



INDEX			A [mm]	B [mm]	
006950	Ornis	Czarny Černá Čierná Black	180	500	5902808804642

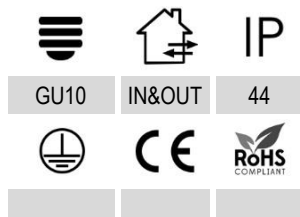

Materiał / Materiál / Material

PL: aluminium

CZ: hliník

SK: hliník

EN: aluminium

Uwagi / Komentář / Komentáre

PL: Zasilacz w komplecie

CZ: Napájení je součástí dodávky

SK: Napájanie je súčasťou dodávky

EN: Power supply included

ARCHITEKTONICZNE LAMPY LED

CZ: Lampy z nerezow  oceli / SK: L mp z nehrdzavej cej ocele / EN: Stainless steel lamps



INDEX



A
[mm]

B
[mm]

C
[mm]



	INDEX	ABC		A [mm]	B [mm]	C [mm]	
A	012815	Lula	Srebrny Srebrn� Srebrn� Silver	450	95	95	5902216798083
B	000095	Seeman	Czarny Czern� Czern� Black	500	130	120	5902216719606
C	000114	Segar		500	105	100	5902216719613
D	6450	Vanita LED		800	100	100	5902216770478



AC 230V



SMD LED



120°



NON-DIM



CRi/Ra



IP



IN&OUT

>80

40000 h

44



Materia  / Materi l / Materi l

PL: stalowa nierdzewna

CZ: nerezov  ocel

SK: nerezovej ocele

EN: steel plate

Uwagi / Koment r / Koment re

PL: Zasilacz w komplecie

CZ: Nap jen  je sou ast  dod vky

SK: Nap janie je s u astou dod vky

EN: Power supply included

OPRAWY LED

CZ: LED svítidlo/ SK: LED svetidlo/ EN: LED lamp

SAMSUNG
LED

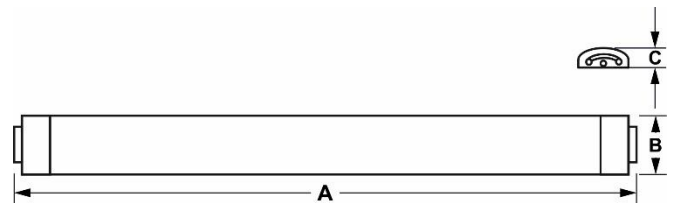

INDEX	ABC				Tc[K]		A [mm]	B [mm]	C [mm]	
012891	Zoya LED	60 W	3600 lm	60lm/W	4000K	Biały biłá bielá white	1510	80	45	5902216798618



AC 230V

SMD LED

120°

NON-DIM



>80

40000 h

65

IN&OUT



Materiał / Materiál / Material

PL: tworzywo sztuczne PC, aluminium

CZ: PC plast, hliník

SK: PC plast, hliník

EN: PC plastic, aluminium

Optymalne warunki eksploatacji:

Optimální provozní podmínky:

Optimálne prevádzkové podmienky:

Optimal operating conditions:

PL: temperatura.: od -25°C do +60°C

wilgotność: <85% ciśnienie: 690-1060 hPa

CZ: teplota: od -25°C do +60°C

vlhkost: <85% tlak: 690-1060 hPa

SK: teplota: od -25°C do +60°C

vlhkost: <85% tlak: 690-1060 hPa

EN: temperature: from -25°C do +60°C

humidity: <85% pressure: 690-1060 hPa

Uwagi / Komentář / Komentáre

PL: Zasilacz w komplecie

CZ: Napájení je součástí dodávky

SK: Napájanie je súčasťou dodávky

EN: Power supply included

EGAN



OPRAWY LED

CZ: LED svítidlo/ SK: LED svetidlo/ EN: LED lamp



INDEX	ABC				Tc[K]		A [mm]	B [mm]	C [mm]	
012892	Egan LED	40 W	3740 lm	94lm/W	4000K	Biały biela white	1210	75	25	5902216798625

AC 230V	SMD LED	120°	NON-DIM
CRI/Ra	Lifespan	IP	IN&OUT
>80	40000 h	65	IN&OUT
RoHS COMPLIANT	CE	RoHS COMPLIANT	

Materiał / Materiál / Material

PL: tworzywo sztuczne PC, aluminium

CZ: PC plast, hliník

SK: PC plast, hliník

EN: PC plastic, aluminum

Optymalne warunki eksploatacji:

Optimální provozní podmínky:

Optimálne prevádzkové podmienky:

Optimal operating conditions:

PL: temperatura.: od -25°C do +60°C

wilgotność: <85% ciśnienie: 690-1060 hPa

CZ: teplota: od -25°C do +60°C

vlhkost: <85% tlak: 690-1060 hPa

SK: teplota: od -25°C do +60°C

vlhkost: <85% tlak: 690-1060 hPa

EN: temperature: from -25°C do +60°C

humidity: <85% pressure: 690-1060 hPa

Uwagi / Komentář / Komentáre

PL: Zasilacz w komplecie

CZ: Napájení je součástí dodávky

SK: Napájanie je súčasťou dodávky

EN: Power supply included

BroLux

OPRAWY LED

CZ: LED svítidlo/ SK: LED svetidlo/ EN: LED lamp

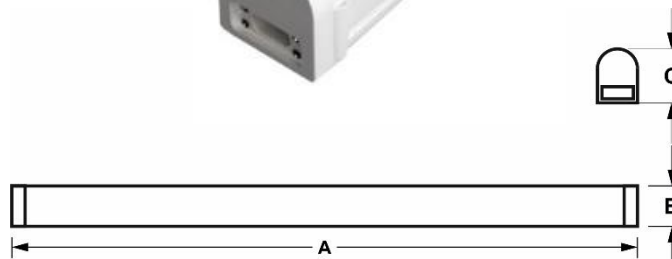

INDEX	ABC				Tc[K]		A [mm]	B [mm]	C [mm]	
012894	Madena LED	45 W	5 400 lm	120lm/W	4000K	Biały biła white	1500	50	65	5902216798632
012895	Madena LED	30 W	3 600 lm	120lm/W	4000K		1200	50	65	5902216798649



012896 Kabel zasilający do opraw Madena 35cm

012897 Linka do powieszenia oprawy Madena 2,0m zestaw 2 sztuki

012896 Łącznik oprawy Madena

AC 230V	SMD LED	120°	NON-DIM
CRI(Ra) >80	40000 h	IP 65	IN&OUT

Uwagi / Komentář / Komentáre

PL: Zasilacz w komplecie

CZ: Napájení je součástí dodávky

SK: Napájanie je súčasťou dodávky

EN: Power supply included

Materiał / Materiál / Material

PL: tworzywo sztuczne PC

CZ: PC plast

SK: PC plast

EN: PC plastic

Optymalne warunki eksploatacji:

Optimální provozní podmínky:

Optimálne prevádzkové podmienky:

Optimal operating conditions:

PL: temperatura.: od -25°C do +60°C

wilgotność: <85% ciśnienie: 690-1060 hPa

CZ: teplota: od -25°C do +60°C

vlhkost: <85% tlak: 690-1060 hPa

SK: teplota: od -25°C do +60°C

vlhkost: <85% tlak: 690-1060 hPa

EN: temperature: from -25°C to +60°C

humidity: <85% pressure: 690-1060 hPa



KORA



OPRAWY PRZYSCHODOWE

CZ: schodišťové svítidlo / SK: schodiskové svietidlo / EN staircase luminaire



INDEX	ABC			Tc[K]		A [mm]	B [mm]	C [mm]	
013642	KORA LED	1,2		4000 K	Antracytowy RAL 7016 antracitová RAL 7016 antracitová RAL 7016 anthracite RAL 7016	150	60	28	5902808804499
013641	KORA LED	1,2		4000 K	Czarny Černá Čierná Black	150	60	28	5902808804505

AC 230V	SMD	57°	NON-DIM
CRI(Ra) >75	40000 h	IP 54	IN&OUT
CE	ROHS COMPLIANT		

Materiał / Materiál / Material

PL: aluminium

CZ: hliník

SK: hliník

EN: aluminium

Uwagi / Komentář / Komentáre

PL: Zasilacz w komplecie

CZ: Napájení je součástí dodávky

SK: Napájanie je súčasťou dodávky

EN: Power supply included

Brolux

www.bowi.com.pl

OPRAWY PRZYSCHODOWE

CZ: schodišťové svítidlo / SK: schodiskové svietidlo / EN staircase luminaire



INDEX	ABC			Tc[K]		A [mm]	B [mm]	C [mm]	
013552	STEP LED	1,2		4000 K	Czarny Černá Čierna Black	97	97	27	5902808803492

AC 230V	SMD	57°	NON-DIM
CRI(Ra) >75	40000 h	IP 54	IN&OUT
CE	ROHS COMPLIANT		

Materiał / Materiál / Material

PL: aluminium

CZ: hliník

SK: hliník

EN: aluminium

Uwagi / Komentář / Komentáre

PL: Zasilacz w komplecie

CZ: Napájení je součástí dodávky

SK: Napájanie je súčasťou dodávky

EN: Power supply included

UGRA

OPRAWY PRZYSCHODOWE

CZ: schodišťové svítidlo / SK: schodiskové svietidlo / EN staircase luminaire



A



B

	INDEX	ABC			Tc[K]		A [mm]	B [mm]	C [mm]	
A	013673	UGRA LED	2 W		4000 K	Antracytowy RAL 7016 antracitová RAL 7016	72	72	45	5902808804369
B	013672	UGRA LED	2 W		4000 K	antracitová RAL 7016 anthracite RAL 7016	72	72	45	5902808804376

AC 230V	SMD	57°	NON-DIM
CRI(Ra) >80	40000 h	IP 54	IN&OUT
CE	RoHS COMPLIANT		

Materiał / Materiál / Material

PL: aluminium

CZ: hliník

SK: hliník

EN: aluminium

Uwagi / Komentář / Komentáre

PL: Zasilacz w komplecie

CZ: Napájení je součástí dodávky

SK: Napájanie je súčasťou dodávky







EN: Power supply included

Brolux

DIODY LED

CZ: LED diody / SK: LED diódy / EN: LED



INDEX		 Lm			 Tc[K]	
010503	10W	800	36	300 mA	3000K	5902216706798
010502	10W	800	36	300 mA	4500K	5902216706804
010501	10W	800	36	300 mA	6500K	5902216706811
010505	20W	1800	36	600 mA	3000K	5902216706828
010504	20W	1600	36	600 mA	4500K	5902216785083
010506	20W	2000	36	600 mA	6500K	5902216706835
5583	30W	2400	36	900 mA	3000K	5902216706842
000551	30W	2400	36	900 mA	4500K	5902216706859
010507	30W	2400	36	900 mA	6500K	5902216706866
6652	50W	4000	36	1500 mA	3000K	5902216706873
6092	50W	4000	36	1500 mA	4500K	5902216706880
010508	50W	4000	36	1500 mA	6500K	5902216700826



COB



POWER COB



DIODY LED

CZ: LED diody / SK: LED diódy / EN: LED









A



B



C

	INDEX						
A	010443	5W	475 lm	20V	300 mA	6500K	5902216712218
B	010444	15W	1575 lm	50V	300 mA	3000K	5902216774858
B	010445	15W	1575 lm	50V	300 mA	4500K	5902216774865
B	010446	15W	1575 lm	50V	300 mA	6500K	5902216706781
C	008165	20W	1800 lm	36V	600 mA	3000K	5902216774872
C	010447	20W	2100 lm	36V	600 mA	4500K	5902216774889



COB



Br^olux

DIODY LED

CZ: LED diody / SK: LED diódy / EN: LED

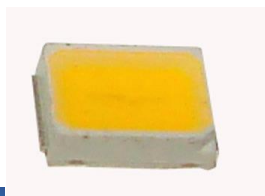

A



B



C



D

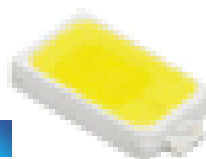

E

	INDEX						
		0,2W	Lm	3,6V	60 mA	3000K	
A	004193	0,2W	20 lm	3,6V	60 mA	3000K	5902216700659
A	192	0,2W	23 lm	3,2V	60 mA	3000K	5902216700666
A	004629	0,2W	22 lm	3,6V	60 mA	6500K	5902216775091
B	002661	0,09W	9 lm	3,6V	30 mA	3000K	5902216775107
B	004122	0,09W	10 lm	3,6V	30 mA	6500K	5902216775114
C	001977	0,06W	5,5 lm	3,6V	20 mA	3000K	5902216775268
C	002048	0,06W	6 lm	3,6V	20 mA	6500K	5902216775275
D	002053	0,18W	17 lm	3,6V	20 mA	3000K	5902216790001
D	002353	0,18W	18 lm	3,6V	20 mA	6500K	5902216790018
E	9303	0,5W	60 lm	3,4V	150 mA	3000K	5902216700673
E	000062	0,5W	55 lm	3,4V	150 mA	3000K	5902216700680
E	001294	0,5W	60 lm	3,4V	150 mA	6500K	5902216700697



MIKROFALOWE



CZUJNIKI RUCHU

CZ: snímače pohybu / SK: snímač pohybu / EN: motion sensor



	INDEX	Max. load	Max. distance	Light level	IP	W x H x D		
A	010556	300W	230 VAC	8m	3-2000Lux	IP20 Biały biła white	77.7×46.5×44 mm	5902216724921
B	1177	100W	230 VAC	1m	3-2000Lux		70×40×26 mm	5902216788961
C	1166	100W	24 VAC	1m	3-2000Lux		90×41×43 mm	5902216722347
C	008655	100W	12 VDC	8m	3-2000Lux		90×41×43 mm	5902216725201
D	92	300W	230 VAC	16m	3-2000Lux		90×41×39 mm	5902216724938
E	004440	600W	230 VAC	16m	3-2000Lux		77.7×45×25.5 mm	5902216786523
F	010557	300W	230 VAC	8m	3-2000Lux		Ø 76×75.4 mm	5902216788978
G	010558	300W	230 VAC	8m	3-2000Lux		Ø 93×42mm	5902216786530
H	011754	1200W	230 VAC	10m	10-500Lux		Ø90×55 mm	5902216787261
I	011755	1200W	230 VAC	10m	10-500Lux	Ø90×43 mm	5902216787278	

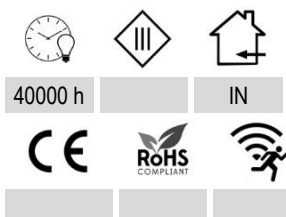

Uwagi / Komentář / Komentáre

PL: Zażęczenie przy świetle <30lux

CZ: Působí na okolní světlo pod 30lux

SK: Působí na okolité svetlo pod 30lux

EN: Turn on under light level of 30lux

Uwagi / Komentář / Komentáre

PL: Wytęczenie po 20s bez ruchu

CZ: doba svícení 20s

SK: Doba svietenia 20s

EN: Turn off after 20s without motion

Materiał / Materiál / Materiál

PL: Tworzywo sztuczne PC

CZ: PC Plast

SK: PC Plast

EN: PC Plastic

Uwagi / Komentář / Komentáre

PL: Zasięg wykrywania ruchu max 6m (<24°C)

CZ: Maximální dosah čidla 6m (<24°C)

SK: Maximálny dosah čidla 6m (<24°C)

EN: Max. motion detection distance 6m (<24°C)

Uwagi / Komentář / Komentáre

PL: Kąt działania czujnika 360°

CZ: Rozsah čidla pohybu 360°

SK: Uhol činnosti pohybového čidla 360°

EN: Sensor angle 360°

BroLux

MIKROFALOWE ZINTEGROWANE Z ZASILACZEM



CZUJNIKI RUCHU

CZ: snímače pohybu / SK: snímač pohybu / EN: motion sensor



A

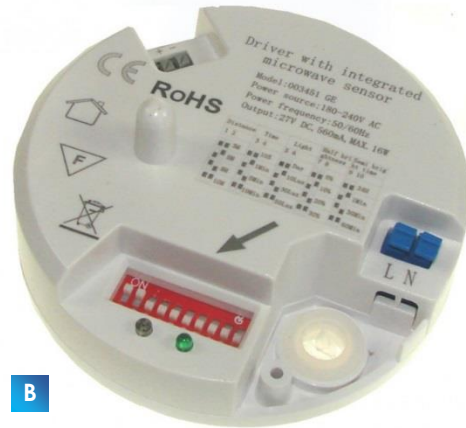

B

	INDEX	Max. load	Ma. distance	Light level	IP	Biały biłá bielá white	Ø x H		
A	004424	16W	500W	24VDC	8m	2-2000Lux	IP20	Ø73x46	5902216748941
B	003451	16W	500W	AC 230V	10m	3-5000Lux			Ø93x42

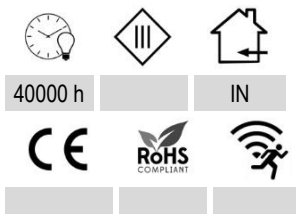

Uwagi / Komentář / Komentáre

PL: Zażęczenie przy świetle <30lux

CZ: Působí na okolní světlo pod 30lux

SK: Působí na okolité svetlo pod 30lux

EN: Turn on under light level of 30lux

Uwagi / Komentář / Komentáre

PL: Wytęczenie po 20s bez ruchu

CZ: doba svícení 20s

SK: Doba svietenia 20s

EN: Turn off after 20s without motion

Materiał / Materiál / Material

PL: Tworzywo sztuczne PC

CZ: PC Plast

SK: PC Plast

EN: PC Plastic

Uwagi / Komentář / Komentáre

PL: Zasięg wykrywania ruchu max 6m (<24°C)

CZ: Maximální dosah čidla 6m (<24°C)

SK: Maximálny dosah čidla 6m (<24°C)

EN: Max. motion detection distance 6m (<24°C)

Uwagi / Komentář / Komentáre

PL: Kąt działania czujnika 360°

CZ: Rozsah čidla pohybu 360°

SK: Uhol činnosti pohybového čidla 360°

EN: Sensor angle 360°



CZUJNIKI RUCHU

CZ: snímače pohybu / SK: snímač pohybu / EN: motion sensor



	INDEX	Max. load	Max. distance	Light level	IP	Ø x H		
A	5435	40W	230 VAC	5 m	3-2000 Lux	IP20	20×30 mm	5902216740914
B	000487	40W	230 VAC	5 m	3-2000 Lux	IP20	26×30 mm	5902216722354
C	010559	300W	230 VAC	6 m	3-2000 Lux	IP20	76×72 mm	5902216786547
D	010560	200W	230 VAC	6 m	3-2000 Lux	IP20	55×39×25 mm	5902216724945
E	010561	300W	230 VAC	6 m	3-2000 Lux	IP20	72.4×90 mm	5902216730731
F	010563	300W	230 VAC	12 m	3-2000 Lux	IP44	84.6×63.4×91.6 mm	5902216730717
G	010564	300W	230 VAC	12 m	3-2000 Lux	IP44	95×87×76 mm	5902216783041
H	010565	300W	230 VAC	9 m	3-2000 Lux	IP20	80×80×35.5 mm	5902216786561
I	010567	300W	230 VAC	6 m	3-2000 Lux	IP20	88×42 mm	5902216786554
J	010568	300W	230 VAC	6 m	3-2000 Lux	IP20	88×55 mm	5902216730724
K	6833	300W	230 VAC	9 m	2-100 Lux	IP20	98,3×81,5×45 mm	5902216786639

Biały
bielá
white



40000 h



IN



PIR

Uwagi / Komentář / Komentáre

PL: Zażądzenie przy świetle <30lux

CZ: Působí na okolní světlo pod 30lux

SK: Působí na okolité svetlo pod 30lux

EN: Turn on under light level of 30lux

Uwagi / Komentář / Komentáre

PL: Wyłączenie po 20s bez ruchu

CZ: doba svícení 20s

SK: Doba svietenia 20s

EN: Turn off after 20s without motion

Materiał / Materiál / Materiál

PL: Tworzywo sztuczne PC

CZ: PC Plast

SK: PC Plast

EN: PC Plastic

Uwagi / Komentář / Komentáre

PL: Zasięg wykrywania ruchu max 6m (<24°C)

CZ: Maximální dosah čidla 6m (<24°C)

SK: Maximálny dosah čidla 6m (<24°C)

EN: Max. motion detection distance 6m (<24°C)

Uwagi / Komentář / Komentáre

PL: Kąt działania czujnika 360°

CZ: Rozsah čidla pohybu 360°

SK: Uhol činnosti pohybového čidla 360°

EN: Sensor angle 360°

CZUJNIKI ZMIERZCHOWE

CZ: snímač soumraku/ SK: snímač súmraku/ EN: twilight sensor



A



B



C



D



E

	INDEX	Max. load		Light level	IP		L x W x H	
A	011587	300W	AC 230V	5-15Lux	IP20	Biały biłá white	125 x 78.8mm	5902216786578
B	011584	400W	AC 230V	5-50Lux	IP44		82x125 mm	5902216786585
C	221	300W	AC 230V	5-50Lux	IP54		56.8x37.3x24mm	5902216786615
D	222	300W	AC 230V	2-100Lux	IP65	Szary Šedá Šedá Grey	90x66x35mm	5902216786622
E	6747	300W	AC 230V	2-100Lux	IP65		63.4x48x27.3mm	5902216786608



40000 h



IN



Materiał / Materiál / Material

PL: Tworzywo sztuczne PC

CZ: PC Plast

SK: PC Plast

EN: PC Plastic

Uwagi / Komentář / Komentáre

PL: Kąt działania czujnika 360°

CZ: Rozsah čidla pohyblu 360°

SK: Uhol činnosti pohybového čidla 360°

EN: Sensor angle 360°



0-10 V



CZUJNIKI ŚWIATŁA OTOCZENIA

CZ: snímač okolního světla / SK: snímač okolitého svetla / EN: ambient light sensor



INDEX	Oświetlenie	IP		 Ø x H	
7170	50-800Lux	IP20	Biały biłá bielá white	Ø69*38mm	5902216786592

Materiał / Materiál / Material

PL: Tworzywo sztuczne PC

CZ: PC Plast

SK: PC Plast

EN: PC Plastic



40000 h

IN



Uwagi / Komentář / Komentáre

PL: Kąt działania czujnika 360°

CZ: Rozsah čidla pohyblu 360°

SK: Uhol činnosti pohybového čidla 360°

EN: Sensor angle 360°

Brolux

STEROWANE RADIOWO (RF)



KONTROLERY LED RGB Z PILOTEM PRZYCISKOWYM

CZ: LED kontroléry / SK: LED kontroléry / EN: LED controllers



A



B



C



D



E



	INDEX	IN	(full/1 channel)	(12V/24V)		(30/m, 60/m – 12V)	L x W x H	
A	6295	12÷24VDC	30A / 10A	360W / 720W	4	50m / 25m	100×90×40	5902216735552
B	1325	12÷24VDC	12A / 4A	144W / 288W	6	20m / 10m	130×40×30	5902216735569
C	000678	12÷24VDC	6A / 2A	72W / 144W	20	10m / 5m	128×64×24	5902216789883
C	1326	12÷24VDC	12A / 4A	144W / 288W	20	20m / 10m	128×64×24	5902216717473
D	5382	12÷24VDC	6A / 2A	72W / 144W	24	10m / 5m	62×35×23	5902216703063
E	010975	12÷24VDC	6A / 2A (12V) 3A / 1A (24V)	72W / 72W	28	10m / 5m	62×35×23	5902216711532



STEROWANE RADIOWO (RF)



KONTROLERY LED RGB Z PILOTEM DOTYKOWYM

CZ: LED kontroléry / SK: LED kontroléry / EN: LED controllers



	INDEX	IN	(full/1channel)	(12V/24V)		(30m, 60m – 12V)	L x W x H	
A	5762	12÷24VDC	18A / 6A	216W / 432W	5 + ring dot.	30m / 15m	85×64×24	5902216721968
B	001601	12÷24VDC	18A / 6A (12V)	216W / 216W	6 + ring dot.	30m / 15m	90×70×28	5902216789876
C	001954	12÷24VDC	18A / 6A (12V)	216W / 216W	6 + ring dot.	30m / 15m	90×70×28	5902216735583
D	001966	12÷24VDC	18A / 6A (12V)	216W / 216W	6 + ring dot.	30m / 15m	90×70×28	5902216735576
E	010889	12÷24VDC	18A / 6A (12V)	216W / 216W	6 + ring dot.	30m / 15m	85x44x22	5902216711488
F	010890	12÷24VDC	18A / 6A (12V)	216W / 216W	6 + ring dot.	30m / 15m	85x44x22	5902216711495
G	010898	12÷24VDC	24A / 8A (12V)	288W / 288W	6 + ring dot.	30m / 15m	126x48x26	5902216711440
H	010877	12÷24VDC	18A / 6A	216W / 432W	5 + ring dot.	30m / 15m	85×64×24	5902216721951











STEROWANE NA PODCZERWIEN' (IR)

KONTROLERY LED RGB

CZ: LED kontroléry / SK: LED kontroléry / EN: LED controllers



	 INDEX	 IN	 (full/1 channel)	 (12V/24V)		 (30/m, 60/m – 12V)	 L x W x H	
A	004362	12÷24VDC	6A / 2A	72W / 144W	24	10m / 5m	65×35×23mm	5902216712263
B	000972	12÷24VDC	18A / 6A	216W / 432W	24	30m / 15m	64×61×27mm	5902216714243
C	000677	12VDC	6A / 2A	72W	44	10m / 5m	65×35×23mm	5902216712270
D	000681	12÷24VDC	12A / 4A	144 / 288W	44	20m / 10m	128×64×24mm	5902216721418



WZMACNIACZE, KONTROLERY LED RGB

CZ: LED kontroléry / SK: LED kontroléry / EN: LED controllers



A



B



C



D

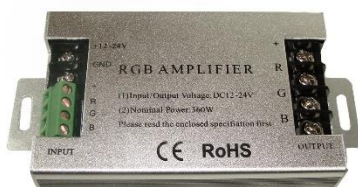

E



F

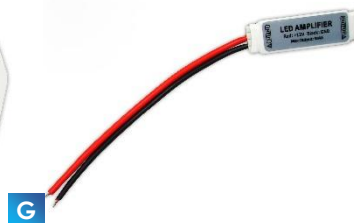

G



H

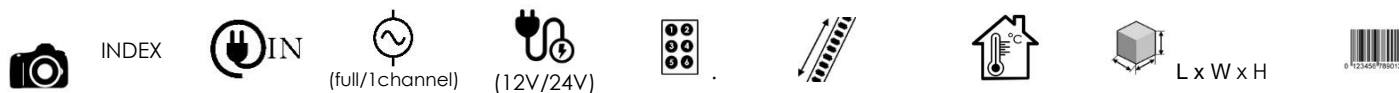

	INDEX	IN	(full/1channel)	(12V/24V)	5 + ring dot.	(30/m, 60/m - 12V)	-20°C ÷ +60°C	L x W x H	Barcode
A	6281	12÷24VDC	24A / 8A	288W / 576W	5 + ring dot.	(30/m, 60/m - 12V)	-20°C ÷ +60°C	86×86×25mm	5902216735545
B	1324	12÷24VDC	12A / 4A	144W / 288W	3	40m / 20m	-20°C ÷ +60°C	130×40×30mm	5902216746251
C	6286	12÷24VDC	24A / 8A	288W / 576W	-	20m / 10m	-20°C ÷ +60°C	82×61×28mm	5902216714236
D	5826	12÷24VDC	6A / 2A	72W / 144W	3	30m / 15m	-20°C ÷ +60°C	41x12x3mm	5902216755529
E	009620	12÷24VDC	10A		-	-	-20°C ÷ +60°C	80x60x28mm	5902216722002
F	5980	12÷24VDC	18A / 6A	216W / 432W	13+ 2x ring	-	-20°C ÷ +60°C	85x45x23mm	5902216711556
G	5337	12VDC	6A		-	-	-20°C ÷ +60°C	41x12x3mm	5902216784956
H	6134	-	-	-	9 + ring dot.	-	-20°C ÷ +60°C	80x40x15mm	5902216711549



STEROWNIKI LED



STEROWNIKI LED

CZ: LED ovladače / SK: LED ovládače / EN: LED drivers



A



B



C



D



E



INDEX



IN channels



(1channel)



(12V)



(24V)



	INDEX	IN channels	(1channel)	(12V)	(24V)	-20°C ÷ +60°C	2,4GHz	5902216723184	
A	005753	12-24V	3	4A	144W	288W	-20°C ÷ +60°C	2,4GHz	5902216723184
B	005752	5-36V	3	6A	216W	432W	-20°C ÷ +60°C	2,4GHz	5902216723191
C	5386	5-24VDC	4	5A	240W	480W	-20°C ÷ +60°C	2,4GHz	5902216723207
D	004692	5-36V	1	8A	96W	192W	-20°C ÷ +60°C	2,4GHz	5902216723214
E	003049	5-36V	4	4A	240W	480W	-20°C ÷ +60°C	2,4GHz	5902216755949



KONTROLERY LED RGB



KONTROLERY LED RGB

CZ: LED kontroléry / SK: LED kontroléry / EN: LED controllers



A



B



C



D



INDEX



channels



(1 channel)



(12V)



(24V)



-20°C ÷ +60°C



2,4GHz



590221 6755567

	INDEX	IN channels	(1 channel)	(12V)	(24V)	-20°C ÷ +60°C	2,4GHz	590221 6755567	
A	007674	12-24V	3	4A	144W	288W	-20°C ÷ +60°C	2,4GHz	590221 6723092
B	005750	12-24V	4	3A	144W	288W	-20°C ÷ +60°C	2,4GHz	590221 6722934
C	004641	12-24V	3	6A	216W	432W	-20°C ÷ +60°C	2,4GHz	590221 6722941
D	010878	12-24V	4	6A	288W	576W	-20°C ÷ +60°C	2,4GHz	



Brulux

KONTROLERY LED RGBW

KONTROLERY LED RGBW

CZ: LED kontroléry / SK: LED kontroléry / EN: LED controllers











A



B



C

	 INDEX	 IN	 (full/1channel)	 (12V/24V)		 (30/m, 60/m – 12V)	 L x W x H	
A	001415	12÷24VDC	16A / 2A	72W / 144W	40 buttons	10m / 5m	128x62x50	5902216721999
B	010899	12÷24VDC	16A / 4A	192W / 384W	9 + ring dot.	28m / 14m	86x86x35	5902216711464
C	010900	12÷24VDC	16A / 4A	192W / 384W	9 + ring dot.	28m / 14m	86x86x35	5902216711457



KONTROLERY LED RGB – PANEL



KONTROLERY LED RGB – PANEL

CZ: LED kontroléry / SK: LED kontroléry / EN: LED controllers



A



B



C

	INDEX	channels	(1channel)	(12V)	(24V)	-20°C ÷ +60°C	L x W x H	
A	007676	3 / 4	4A/ 3A	144W	288W	-20°C ÷ +60°C	86x86x36,5mm	5902216755536
B	007677	3	4A	144W	288W	-20°C ÷ +60°C	86x86x36,5mm	5902216755604
C	007678	3 / 4	4A/ 3A	144W	288W	-20°C ÷ +60°C	86x86x36,5mm	5902216755628



BroLux

WIFI, BLUETOOTH



KONTROLERY LED

CZ: LED kontroléry / SK: LED kontroléry / EN: LED controllers



A



B



C



D

	INDEX	IN channels	(1channel)	(12V)	(24V)			OS (operating system)	
--	-------	-------------	------------	-------	-------	--	--	-----------------------	--

A	000680	5-24V	3	4A	144W	288W	-20°C ÷ +60°C	2,4GHz	iOS, Android Konwertuje sygnał 2,4GHz na WIFI	5902216723108
B	1194	12-24V	4	3A	144W	288W	-20°C ÷ +60°C	2,4GHz	iOS, Android	5902216723177
C	010891	7,5÷24VDC	3	4A	144W	288W	-20°C ÷ +60°C	2,4GHz	iOS, Android	5902216711501
D	010892	7,5÷24VDC	3	4A	144W	288W	-20°C ÷ +60°C	2,4GHz	iOS, Android	5902216755802



Br^olux

2,4GHz



PILOT KONTROLERA LED

CZ: LED kontroléry / SK: LED kontroléry / EN: LED controllers remote



A



B



C



D



E



F



G



H







I



J



K

	INDEX	ZONE			
A	010888	1	30m	2,4GHz	5902216723115
B	005834	4	30m	2,4GHz	5902216723122
C	005833	8	30m	2,4GHz	5902216723139
D	009696	1	30m	2,4GHz	5902216756007
E	009622	4	30m	2,4GHz	5902216755956
F	009807	4	30m	2,4GHz	5902216755932
G	009808	4	30m	2,4GHz	5902216789944
H	009682	1	30m	2,4GHz	5902216756021
I	009680	4	30m	2,4GHz	5902216755963
J	010816	1	30m	2,4GHz	5902216755970
K	010820	4	30m	2,4GHz	5902216756038



PILOT KONTROLERA/ŚCIEMNIACZA LED

CZ: LED kontroléry / SK: LED kontroléry / EN: LED controllers remote



A

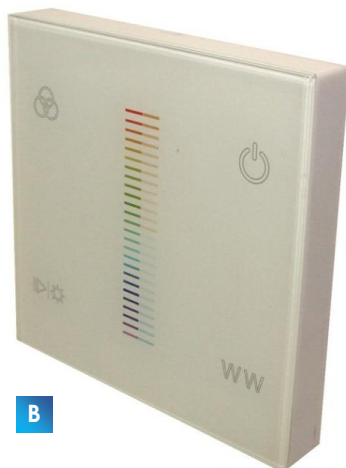

B



C



INDEX



L x W x H



	INDEX	IN	Temperature	Dimensions	Frequency	Barcode
A	007687	3V (bateria litowa)	-20°C ÷ +60°C	86*86*13,5mm	2,4GHz	5902216726840
B	007688	3V (bateria litowa)	-20°C ÷ +60°C	86*86*13,5mm	2,4GHz	5902216789937
C	007686	3V (bateria litowa)	-20°C ÷ +60°C	86*86*13,5mm	2,4GHz	5902216755703



PILOT ŚCIEMNIACZA LED

PILOT ŚCIEMNIACZA LED

CZ: stmívač LED / SK: stmievač LED/ EN: dimmer LED remote



	INDEX	ZONE			
A	007679	1	30m	2,4GHz	5902216755680
B	004658	1	30m	2,4GHz	5902216723146
C	004691	4	30m	2,4GHz	5902216723153
D	004659	8	30m	2,4GHz	5902216723160
E	007690	4	30m	2,4GHz	5902216755758
F	007689	1	30m	2,4GHz	5902216755741
G	009618	4	30m	2,4GHz	5902216756014
H	009800	5	30m	2,4GHz	5902216755994





PRZEŁĄCZNIKI



ŚCIEMNIACZA LED I KONTROLERA LED

CZ: stmívače LED / SK: stmievačové LED / EN: LED dimmer switches



A



B



INDEX



L x W x H



	INDEX	ABC	L x W x H	Barcode
A	007691	Przełącznik ściemniacza LED monostabilny 1 klawiszowy	86x86x36,5mm	5902216755635
B	007692	Przełącznik kontrolera LED monostabilny 2 klawiszowy	86x86x36,5mm	5902216755642



BroLux

REGULATORY



REGULATORY ŚCIEMNIACZA LED

CZ: regulatory stmívače LED / SK: stmievačové regulátory LED / EN: dimmer regulators LED



A



B

INDEX



INDEX	IN	OUT	Temperature	Dimensions (L x W x H)	Barcode
007670	230V/50Hz	0/1-10V	-20°C ÷ +60°C	86*86*36,5mm	5902216755574
007667	230V/50Hz	0/1-10V	-20°C ÷ +60°C	86*86*36,5mm	5902216755550



BroLux

ŚCIEMNIACZE LED



ŚCIEMNIACZE LED

CZ: stmívač LED napětí / SK: stmievač LED napätie / EN: dimmer LED voltage



	INDEX	IN channels	(1channel)	(12V)	(24V)	Temperature Range	Frequency	Dimensions (L x W x H)	Barcode	
A	007671	12-24V	3	4A	144W	288W	-20°C ÷ +60°C	2,4GHz	160x65x40mm	5902216726864
B	007669	12-24V	3	4A	144W	288W	-20°C ÷ +60°C	2,4GHz	160x65x40mm	5902216755734
C	004692	5-36V	1	8A	96W	192W	-20°C ÷ +60°C	2,4GHz	160x65x40mm	5902216723214
D	007675	12-48V	1	6A	144W	288W	-20°C ÷ +60°C	2,4GHz	86*86*36,5mm	5902216755611
E	007672	5-24V	4	3A	144W	288W	-20°C ÷ +60°C	2,4GHz	86*86*36,5mm	5902216755581
F	007673	5-24V	2	5A	120W	240W	-20°C ÷ +60°C	2,4GHz	86*86*36,5mm	5902216755598



Brolux

STEROWANE RADIOWO (RF)



ŚCIEMNIACZE LED NAPIĘCIOWE

CZ: stmívač LED napětí / SK: stmievač LED napätie / EN: dimmer LED voltage

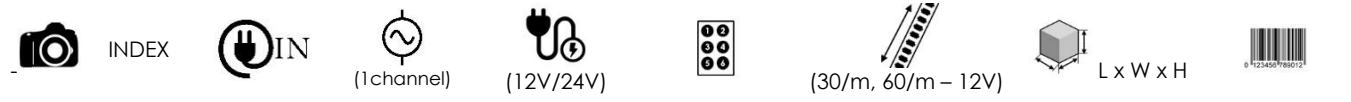

	INDEX	IN	(1channel)	(12V/24V)	(30/m, 60/m - 12V)	L x W x H	Barcode	
A	001652	12÷24VDC	8A / 8A	96W / 192W	3	40m / 20m	110×56×34mm	5902216789906
B	005369	12÷24VDC	8A / 8A	96W / 192W	3	20m / 10m	110×56×34mm	5902216712287
C	001494	12÷24VDC	10A / 10A	120W / 240W	28	50m / 25m	106x63x47mm	5902216723221
D	002824	12÷24VDC	12A / 6A (2 kanały)	144W / 288W	5 + ring dot.	30m / 15m	85×64×24mm	5902216746268
E	003180	12÷24VDC	12A / 6A (2 kanały)	144W / 288W	5 + ring dot.	30m / 15m	205x10x50mm	5902216755765
F	006413	12÷24VDC	8A / 8A	96W / 192W	-	-	97x65x58mm	5902216721975
G	010901	12÷24VDC	8A / 4A	96W / 192W	1	2x20m / 2x10m	86x86x35mm	5902216711525
H	010902	12÷24VDC	8A / 4A	96W / 192W	1	2x20m / 2x10m	86x86x35mm	5902216711471
I	004761	-	-	-	-	-	-	5902216711563
J	1326	12÷24VDC	8A / 4A	96W / 192W	20		114×65×25 mm	5902216717473



STEROWANE RADIOWO (RF)



ŚCIEMNIACZE LED PRĄDOWE

CZ: stmívač LED proud / SK: stmievač LED prúd / EN: dimmer LED current



A



B



INDEX



(12V/24V)



L x W x H



	INDEX	IN	~	(12V/24V)	Terminal Block	L x W x H	Barcode
A	005583	12÷24VDC	350mA	4,2W / 8,4W	12	87×87×53mm	5902216755925
A	006571	12÷24VDC	700mA	8,4W / 16,8W	12	87×87×53mm	5902216789913
B	002066	12÷24VDC	8A /8A	96W / 192W	1	89×59×35mm	5902216785977



BroLux

DO TAŚM 230V



KONTROLERY LED RGB

CZ: LED kontroléry / SK: LED kontroléry / EN: LED controllers



A



B



INDEX



IN



(full/1 channel)



System



Programms

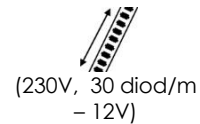

0 912345 789012

A	005335	230VAC	6A / 2A	1400W	RF	4	7 stat. + dyn.	100	5902216755796
B	005336	230VAC	3A / 1A	700W	IR	24	24 stat. + dyn.	50	5902216755789



BroLux

KONTROLERY LED DMX

KONTROLERY LED DMX

CZ: LED kontroléry / SK: LED kontroléry / EN: LED controllers



A

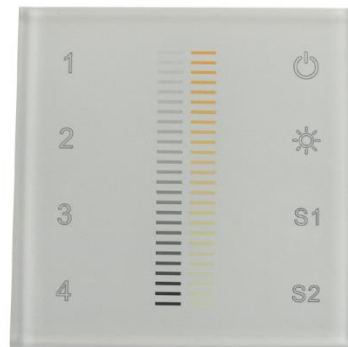





B











C



D

	 INDEX	 IN	For decoders	Can connect Master unit	Remote control		 L x W x H	
A	010893	12-24V	3-channel	YES	RF	>20m	150x121x36	5902216755772

	 INDEX	 IN	Sygnal wyjściowy:	 Adjustment levels	 RF 2,4GHz	 -20°C ÷ +60°C	 L x W x H	 2,4GHz	
B	007680	230V/50Hz	DMX512(19 90) + RF 2,4GHz	0 - 100%	1/256	30m	86x86x36,5mm	2,4GHz	5902216755659
C	007681	230V/50Hz	DMX512(19 90) + RF 2,4GHz	0 - 100%	1/256	30m	86x86x36,5mm	2,4GHz	5902216755710
D	007682	230V/50Hz	DMX512(19 90) + RF 2,4GHz	0 - 100%	1/256	30m	86x86x36,5mm	2,4GHz	5902216726857



Brlux

www.bowi.com.pl

ŚCIEMNIACZE LED DMX



ŚCIEMNIACZE LED DMX

CZ: stmívač LED DMX / SK: stmievač LED DMX / EN: dimmer LED DMX



A



B



	INDEX	IN	Signal	Channels	Adjustment levels	RF 2,4GHz	Temperature	L x W x H	Wireless	Barcode	
A	007683	230V/50Hz	DMX512(1990) + RF 2,4GHz	2	0 - 100%	1/256	30m	-20°C ÷ +60°C	86*86*36,5mm	2,4GHz	5902216755727
B	007685	230V/50Hz	DMX512(1990) + RF 2,4GHz	4	0 - 100%	1/256	30m	-20°C ÷ +60°C	86*86*36,5mm	2,4GHz	5902216755697



Br^olux

www.bowi.com.pl

DMX



DMX

CZ: DMX / SK: DMX / EN: DMX



A



B

	INDEX	IN	DMX channel	(full/1channel)	(12V/24V)	(30/m, 60/m – 12V)	L x W x H	
A	010894	12-24V	3	12A/4A	144W/288W	20m/10m	160x65x40	5902216718685

	INDEX	Type	IN	Channel choose		L x W x H	
B	010895	Transmitter	dedykowany zasilacz (5V)	yes	-	91x39x31	5902216755543
B	010896	Receiver	dedykowany zasilacz (5V)	yes	500m	91x39x31	5902216711518
B	010897	Receiver	dedykowany zasilacz (5V)	yes	1600m	91x39x31	5902216718692



REFLEKTORY LED



REFLEKTORY LED

CZ: LED světlomety/ SK: LED bodové svetlá/ EN: LED spotlights



	INDEX	2*5W	9V-80V	Lm	Cree	Tc[K]		W×H×D	
A	000064	2*5W	9V-80V	980 lm	CREE	niebieski		140*65*90mm	5902216712430
B	6491	5*3W	9V-80V	950 lm	Power LED	6000K		145*65*70mm	5902216712379
C	001180	6*3W	9V-80V	1150 lm	Power LED	6000K		155*43*50mm	5902216712324
D	003001	6*3W	9V-80V	1100 lm	Power LED	6000K		117*125*30mm	5902216712386
E	002118	9*3W	10V-30V	1650 lm	Power LED	6000K		115*130*55mm	5902216712355
F	3508	1*10W	9V-80V	950 lm	CREE	6000K	Czarny Černá Čierna Black	55*75*63mm	5902216712423
G	6725	16*3W	9V-80V	1660 lm	Power LED	6000K		113*125*54mm	5902216719774
H	3538	16*3W	9V-80V	2800 lm	Power LED	6000K		105*125*60mm	5902216712362
I	003066	4*10W	9V-80V	3350 lm	CREE	6000K		125*153*85mm	5902216712409
J	003744	4*3W	9V-80V	1150 lm	CREE	6000K		84*73*80mm	5902216712393
K	003050	5*3W	9V-80V	900 lm	Power LED	6000K		110*137*35mm	5902216712348
L	5184	6*3W	9V-80V	2250 lm	CREE	6000K		80*75*73mm	5902216712416
M	7226	9*3W	10V-30V	1600 lm	Power LED	6000K		105*125*50mm	5902216712331
N	008252	16*3W	9V-80V	1900 lm	Power LED	6000K		160*95*70mm	5902216719781

IN&OUT 60°
 CRI(Ra) 40000 h IP68
 RoHS COMPLIANT

Materiał / Materiál / Material
 PL: aluminium
 CZ: hliník
 SK: hliník
 EN: aluminum



LISTWY OFF ROAD

CZ: LED světlomety/ SK: LED bodové svetlá/ EN: LED spotlights



A



B



C



D

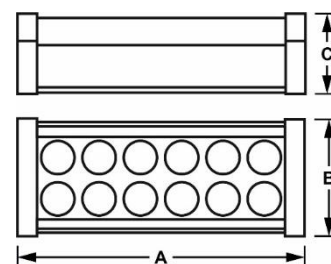

INDEX



Tc[K]



A [mm] B [mm] C [mm]



	INDEX	Power [W]	Voltage [V]	Lumen [lm]	LED Type	Temp [K]	Color	A [mm]	B [mm]	C [mm]	Barcode
A	6895	36W	9V-60V	1300 lm	Power LED	6000K	Czarny Černá Čierná Black	190	86	80	5902216720152
B	004060	72W	9V-60V	2600 lm	Power LED	6000K		345	86	80	5902216720169
C	002365	120W	9V-60V	4400 lm	Power LED	6000K		550	86	80	5902216720176
D	466	180W	9V-60V	6600 lm	Power LED	6000K		805	86	80	5902216720176
D	6703	240W	9V-60V	8800 lm	Power LED	6000K		1060	86	80	5902216724099
D	3601	300W	9V-60V	11000 lm	Power LED	6000K		1315	86	80	5902216724105



IN&OUT



30°



>73



40000 h

IP

68



Materiał / Materiál / Material

PL: aluminium

CZ: hliník

SK: hliník

EN: aluminum

LISTWY OFF ROAD

CZ: LED světlomety/ SK: LED bodové svetlá/ EN: LED spotlights



A



B

CREE

LEDs



C



D

	INDEX	36W	9V-60V	1300 lm	6000K		W×H×D	
A	6842	36W	9V-60V	1300 lm	6000K	Czarny Černá Čierná Black	160*68*80mm	5902216720190
B	6199	54W	9V-60V	1750 lm	6000K		232*65*80mm	5902216720206
C	6394	72W	9V-60V	2600 lm	6000K		300*65*80mm	5902216720213
D	581	90W	9V-60V	3300 lm	6000K		368*65*80mm	5902216720220
D	1611	108W	9V-60V	3950 lm	6000K		436*65*80mm	5902216720237

IN&OUT	30°	LED
>73	40000 h	IP 68

Materiał / Materiál / Material
PL: aluminium
CZ: hliník
SK: hliník
EN: aluminum

LISTWY OFF ROAD

CZ: LED světlomety/ SK: LED bodové svetlá/ EN: LED spotlights



A



B

CREE®

LEDs

	INDEX	68W	IN 9V-60V	Lm 2250	Tc[K] 6000K	Czarny Černá Čierna Black	W×H×D 345*86*80mm	5902216720244
A	1607	68W	9V-60V	2250 lm	6000K	Czarny Černá Čierna Black	345*86*80mm	5902216720244
B	749	112W	9V-60V	4200 lm	6000K		550*86*80mm	5902216720251

IN&OUT	30°	LED
CRI(Ra) >73	40000 h	IP 68
		RoHS COMPLIANT

Materiał / Materiál / Material

PL: aluminium

CZ: hliník

SK: hliník

EN: aluminum

LISTWY OFF ROAD

CZ: LED světlomety/ SK: LED bodové svetlá/ EN: LED spotlights



A

B

	INDEX	72W	IN 9V-60V	2600 lm	Power LED	6000K		W×H×D	
A	6531	72W	9V-60V	2600 lm	Power LED	6000K	Czarny Černá Čierná Black	345*86*80mm	5902216720268
B	1588	120W	9V-60V	4400 lm	Power LED	6000K		550*86*80mm	5902216720275
B	000539	180W	9V-60V	6600 lm	Power LED	6000K		805*86*80mm	5902216724112
B	000978	240W	9V-60V	8800 lm	Power LED	6000K		1060*86*80mm	5902216724129
B	000698	300W	9V-60V	11000 lm	Power LED	6000K		1315*86*80mm	5902216724136

IN&OUT	30°
>73	40000 h
IP68	RoHS COMPLIANT

Materiał / Material / Material

PL: aluminium

CZ: hliník

SK: hliník









EN: aluminum

LAMPY OSTRZEGAWCZE

LAMPY OSTRZEGAWCZE

CZ: výstražných světel / SK: výstražné svetlá / EN: warning lamps



	INDEX							
			IN		Tc[K]		W×H×D	
A	008221	12w	10-30V	SMD LED	6500 K	Pomarańczowy Oranžová Oranžový Orange	Ø 164 x 129mm	5902216712515
B	001218	15w	10-30V	SMD LED	6500 K		Ø 133 x 111mm	5902216712522
C	001199	6W	10-30V	SMD LED	6500 K		Ø 89 x 99mm	5902216712546
A	011668	15W	10-30V	SMD LED	6500 K		Ø 160 x 120mm	5902216774773
C	011740	20W	10-30V	SMD LED	6500 K		Ø 91x96mm	5902216787308
C	011741	20W	10-48V	SMD LED	6500 K		Ø 90x95mm	5902216787315
B	008711	36W	10-30V	SMD LED	6500 K		Ø 147x129mm	5902216787322
C	011739	6W	10-30V	SMD LED	6500 K		Ø 91x97mm	5902216787339
D	003617	15w	10-30V	SMD LED	6500 K	Niebieski Modrá Modrý Blue	Ø 147 x 129mm	5902216712539



40000 h



IN&OUT

IP

55



Materiał / Materiál / Material

PL: Tworzywo sztuczne ABS+PS

CZ: Plast ABS+PS

SK: Plast ABS+PS

EN: Plastic ABS +PS



LATARKI



LATARKI Z AKUMULATOREM

CZ: baterka s baterií/ SK: baterku s batériou / EN: flashlight with battery



A



B



C



D



E



F



G



H



I



J



K



L



M



N



O



P



R



S

Br^olux

LATARKI Z AKUMULATOREM

CZ: baterka s baterií/ SK: baterku s batériou / EN: flashlight with battery

	INDEX	Tc[K]	Kolor	Battery Voltage (V)	Battery capacity (mAh)	LED	W×H×D	
A	011401	6500K	czarny	3,7	1,5	SMD LED	45*40*210mm	5902216707528
B	004514	6500K	żółty	3,6	1,2	DIP	120*320*125mm	5902216707535
C	001545	6500K	czerwony	4	800	DIP	600*480*400mm	5902216735873
D	6564	6500K	czarny	4	750	DIP	525*410*370mm	5902216735880
E	577	6500K	czarny moro	4	1100	DIP	570*435*230mm	5902216785205
F	6141	6500K	zielony moro	4	1100	DIP	570*435*230mm	5902216732308
G	011475	6500K	czerwony	4	750	DIP	510*355*340mm	5902216735897
H	011476	6500K	niebieski	4	750	DIP	510*355*340mm	5902216735903
I	011477	6500K	czerwony	4	750	SMD LED	665*400*385mm	5902216735910
J	011478	6500K	niebieski	4	750	SMD LED	665*400*385mm	5902216735927
K	1691	6500K	czarny	4	800	SMD LED	545*450*375mm	5902216735934
L	002888	6500K	czerwony	4	1200	SMD LED	555*340*500mm	5902216735941
M	542	6500K	zielony moro	4	2800	DIP	635*505*325mm	5902216732322
N	514	6500K	czerwony	4	750	DIP	510*425*470mm	5902216735958
O	568	6500K	czerwony	4	720	DIP	565*385*360mm	5902216732315
P	557	6500K	niebieski	4	720	DIP	565*385*360mm	5902216731509
R	004406	6500K	Czarno-żółty	4	1000	SMD/COB	530*290*535 mm	5902216735965
S	1681	6500K	pomarańczowy	4	1600	SMD LED	675*405*340mm	5902216735972

IP

CE



20

Materiał / Materiál / Materiál

PL: Tworzywo sztuczne ABS

CZ: Plast ABS

SK: Plast ABS

EN: Plastic ABS

LATARKI



LATARKI BEZ AKUMULATORA

CZ: Svítilna bez baterie / SK: baterku bez batérie / EN: flashlight without battery



LATARKI BEZ AKUMULATORA

CZ: Svítilna bez baterie / SK: baterku bez batérie / EN: flashlight without battery

	INDEX	Tc[K]	Kolor	Typ	W×H×D	Kod
A	5696	6500K	czarny	SMD LED	41*51*220mm	5902216789968
B	006358	6500K	czarny	SMD LED	263*63*42mm	5902216738980
C	006356	6500K	czarny	SMD LED	220*60*32mm	5902216738966
D	011402	6500K	czarny	SMD LED	45*40*210mm	5902216732094
E	010633	6500K	czerwony	DIP	200*50*22mm	5902216731523
F	004534	6500K	żółty	DIP	200*50*22mm	5902216732049
G	004954	6500K	czerwony	DIP	62.6*97*36.5mm	5902216785212
H	011399	6500K	zielony	DIP	62.6*97*36.5mm	5902216732124
I	005744	6500K	żółty	DIP	62.6*97*36.5mm	5902216732018
J	002373	6500K	czerwony	DIP	58*95*45mm	5902216732292
K	010676	6500K	niebieski	DIP	58*95*45mm	5902216731516
L	005661	6500K	żółty	DIP	58*95*45mm	5902216732261
M	001818	6500K	czarny	DIP	263*63*42mm	5902216738911
N	010651	6500K	czerwony	DIP	122*58*32mm	5902216732285
O	010647	6500K	niebieski	DIP	122*58*32mm	5902216732032
P	6237	6500K	czerwony	DIP	49*45*209mm	5902216709775
R	011400	6500K	żółty	DIP	49*45*209mm	5902216709782
S	002522	6500K	czarny	DIP	41*51*220mm	5902216789975
T	005399	6500K	żółty	DIP	226*63*42mm	5902216789982
U	010791	6500K	niebieski	SMD LED	54*160mm	5902216739031
W	010654	6500K	niebieski	SMD LED	122*58*32mm	5902216732100
X	010659	6500K	żółty	SMD LED	122*58*32mm	5902216789999
Y	006357	6500K	czarny	DIP	220*60*32mm	5902216738973
Z	010667	6500K	czarny	SMD LED	Ø30*165mm	5902216732117
1	10017	6500K	niebieski	DIP	120*60*34mm	5902216738997
2	10059	6500K	czarny	DIP	96*66*250mm	5902216732025
3	003924	6500K	czarny	DIP	68*46*126mm	5902216738881
4	4505	6500K+ czerwony	pomarańczowy	DIP+SMD LED	110*30mm	5902216710023

IP

CE

RoHS
COMPLIANT

20

Materiał / Materiál / Material

PL: Tworzywo sztuczne ABS

CZ: Plast ABS

SK: Plast ABS

EN: Plastic ABS

12V,24V PLASTIKOWE IP67



ZASILACZE LED STAŁONAPIECIOWE

CZ: Napájecí zdroje s konstantním napětím/ SK: Napájacie zdroje s konštantným napätím/ EN: LED power supply constant voltage



INDEX	IN	OUT					L x W x H	
1541	100-240VAC	12VDC	1,0A	12W	100mVpp	-30°C ÷ +45°C	130×24×21mm	5902216747210
154	100-240VAC	12VDC	1,67A	20W	100mVpp	-30°C ÷ +45°C	138×29×21mm	5902216748446
1542	100-240VAC	12VDC	2,5A	30W	100mVpp	-30°C ÷ +45°C	115×34×26mm	5902216703544
156	100-240VAC	12VDC	3,33A	40W	100mVpp	-30°C ÷ +45°C	145×39×30mm	5902216703551
151	100-240VAC	12VDC	5,0A	60W	120mVpp	-30°C ÷ +45°C	160×40×32mm	5902216703568
127	100-240VAC	12VDC	8,33A	100W	120mVpp	-30°C ÷ +45°C	185×50×36mm	5902216703575
012963	100-240VAC	12VDC	8,33A	100W	120mVpp	-30°C ÷ +45°C	165x42x34mm	5902216799202
009755	100-240VAC	12VDC	1A	12W	100mVpp	-30°C ÷ +45°C	120x26x35mm	5902216703261
009765	100-240VAC	12VDC	1,7A	20W	100mVpp	-30°C ÷ +45°C	118×35×26 mm	5902216703292
009782	100-240VAC	12VDC	3,33A	40W	100mVpp	-30°C ÷ +45°C	150x39x30mm	5902216703254
009781	100-240VAC	12VDC	2,5A	30W	100mVpp	-30°C ÷ +45°C	147×40×30mm	5902216703315
009783	100-240VAC	12VDC	5A	60W	120mVpp	-30°C ÷ +45°C	165×42×34mm	5902216703346
001973	100-260VAC	24VDC	0,62A	15W	100mVpp	-30°C ÷ +45°C	36,5x31,5x18,5mm	5902216725218
002981	100-260VAC	24VDC	1,25A	30W	100mVpp	-30°C ÷ +45°C	47x20,5x23mm	5902216725225
001790	100-260VAC	24VDC	2,5A	60W	100mVpp	-30°C ÷ +45°C	47x20,5x23mm	5902216725232

IP



67

IN&OUT



Materiał / Materiál / Materiál

PL: Tworzywo sztuczne

CZ: Plast

SK: Plast

EN: Plastic

Brolux

12V,24 ALUMINIOWE IP67



ZASILACZE LED STAŁONAPIECIOWE

CZ: Napájecí zdroje s konstantním napětím/ SK: Napájacie zdroje s konštantným napätím/ EN: LED power supply constant voltage



INDEX	IN	OUT					L x W x H	
007921	100-240VAC	12VDC	1A	12W	100mVpp	-30°C ÷ +45°C	76x37x28mm	5902216703247
126	85-264VAC	12VDC	1,1A	15W	100mVpp	-30°C ÷ +45°C	132x30x20mm	5902216703278
123	170-264VAC	12VDC	1,5A	20W	80mVpp	-30°C ÷ +45°C	143x30x20mm	5902216703285
1188	170-264VAC	12VDC	2,5A	30W	100mVpp	-30°C ÷ +45°C	220x30x20mm	5902216703308
008911	100-240VAC	12VDC	3A	36W	100mVpp	-30°C ÷ +45°C	200x30x20mm	5902216717978
1181	85-264VAC	12VDC	3,75A	45W	100mVpp	-30°C ÷ +45°C	235x40x22mm	5902216703322
1164	170-264VAC	12VDC	5,0A	60W	80mVpp	-30°C ÷ +45°C	178x68x50mm	5902216703339
013381	230 VAC	12VDC	6,67A	80W	80mVpp	-30°C ÷ +45°C	160x51x32 mm	5902808801559
111	170-264VAC	12VDC	8,5A	100W	80mVpp	-30°C ÷ +45°C	206x130x65mm	5902216703353
1101	170-264VAC	12VDC	12,5A	150W	120mVpp	-30°C ÷ +45°C	235x120x55mm	5902216703506
1085	170-264VAC	12VDC	16,67A	200W	120mVpp	-30°C ÷ +45°C	265x70x55mm	5902216718029
008514	170-264VAC	12VDC	20,83A	250W	180mVpp	-30°C ÷ +45°C	230x120x56mm	5902216703513
003178	185~265VAC	12VDC	12,5A	150W	120mVpp	-30°C ÷ +45°C	120x55x183mm	5902216717985
009754	100-240VAC	12VDC	12,5A	150W	120mVpp	-30°C ÷ +45°C	120x55x183mm	5902216703360
004062	185-265VAC	12VDC	16,7A	200W	120mVpp	-30°C ÷ +45°C	205x120x55mm	5902216720541
008060	185-240VAC	12VDC	20A	240W	180mVpp	-30°C ÷ +45°C	205x120x55mm	5902216720558
1052	170-250VAC	24VDC	2,5A	60W	80mVpp	-30°C ÷ +45°C	178x68x50mm	5902216703520
1054	170-250VAC	24VDC	4,5A	100W	80mVpp	-30°C ÷ +45°C	206x130x65mm	5902216703537
008058	100-240VAC	24VDC	4,2A	100W	80mVpp	-30°C ÷ +45°C	153x88x47mm	5902216747227
007150	170-250VAC	24VDC	8,33A	200W	120mVpp	-30°C ÷ +45°C	230x120x56mm	5902216718012

IP

67 IN&OUT



Materiał / Materiál / Material

PL: aluminium

CZ: hliník

SK: hliník

EN: aluminum

BroLux

12V,24V PLASTIKOWE IP40

ZASILACZE LED STAŁONAPIECIOWE

CZ: Napájecí zdroje s konstantním napětím/ SK: Napájacie zdroje s konstantným napätím/ EN: LED power supply constant voltage



A



B



	INDEX	IN	OUT	Resistance	Power	Ripple	Temperature	Dimensions (L x W x H)	Barcode
A	009886	230VAC	12VDC	0,5A	6W	300mVpp	-30°C ÷ +45°C	42×40×21mm	5902216789777
A	009887	230VAC	12VDC	0,83A	10W	300mVpp	-30°C ÷ +45°C	42×40×21mm	5902216711365
B	009669	230VAC	12VDC	1A	15W	100mVpp	-30°C ÷ +45°C	152×60×23mm	5902216748729
B	009803	230VAC	12VDC	2A	24W	100mVpp	-30°C ÷ +45°C	152×60×23mm	5902216747142
B	009804	230VAC	12VDC	3,5A	42W	120mVpp	-30°C ÷ +45°C	152×60×23mm	5902216711372
B	009805	230VAC	12VDC	4,2A	50W	120mVpp	-30°C ÷ +45°C	152×60×23mm	5902216789784
B	010072	230VAC	24VDC	0,625A	15W	100mVpp	-30°C ÷ +45°C	152×60×23mm	5902216711389

IP 
40 IN&OUT



Materiał / Materiál / Materiál

PL: Tworzywo sztuczne

CZ: Plast

SK: Plast

EN: Plastic



12V,24V MODUŁOWE



ZASILACZE LED STAŁONAPIĘCIOWE

CZ: Napájecí zdroje s konstantním napětím/ SK: Napájacie zdroje s konstantným napätím/ EN: LED power supply constant voltage



INDEX	IN	OUT						L x W x H	
001905	85-264VAC	12VDC	2,1A	25W	80mVpp	+10%, -15%	84x58x38mm	5902216720145	
4549	85-264VAC	12VDC	3,0A	36W	100mVpp	+10%, -15%	84x58x38mm	5902216703186	
4537	85-264VAC	12VDC	5,0A	60W	100mVpp	+10%, -15%	110x80x35mm	5902216703193	
5806	85-264VAC	12VDC	8,5A	100W	100mVpp	+10%, -15%	159x98x38mm	5902216703414	
003539	85-264VAC	12VDC	10,0A	120W	100mVpp	+10%, -15%	159x98x38mm	5902216703421	
000913	85-264VAC	12VDC	12,5A	150W	180mVpp	+10%, -15%	199x98x38mm	5902216717992	
004328	85-264VAC	12VDC	16,5A	200W	180mVpp	+10%, -15%	119x110x50mm	5902216703438	
004330	85-264VAC	12VDC	20,0A	250W	120mVpp	+10%, -15%	119x110x50mm	5902216703445	
304	85-264VAC	12VDC	25,0A	300W	150mVpp	+10%, -15%	215x115x50mm	5902216703452	
005580	85-264VAC	12VDC	29,0A	350W	150mVpp	+10%, -15%	215x115x50mm	5902216703469	
005581	85-264VAC	12VDC	33,0A	400W	150mVpp	+10%, -15%	215x115x50mm	5902216718005	
005582	85-264VAC	12VDC	40,0A	500W	100mVpp	+10%, -15%	238x124x65mm	5902216746701	
7145	85-264VAC	12VDC	50A	600W	100mVpp	+10%, -15%	238x124x65mm	5902216703377	
008888	110-265V	12VDC	1,3A	15W	80mVpp	+10%, -15%	70x40x30mm	5902216715561	
008886	110-265V	12VDC	2,1A	25W	80mVpp	+10%, -15%	85x58x35mm	5902216703179	
010845	85-264VAC	12VDC	8,5A	100W	100mVpp	+10%, -15%	160x98x43mm	5902216703209	
010846	85-264VAC	12VDC	10A	120W	100mVpp	+10%, -15%	199x98x42mm	5902216703216	
010847	85-264VAC	12VDC	12,5A	150W	180mVpp	+10%, -15%	199x98x43mm	5902216703223	
010848	85-264VAC	12VDC	16,5A	200W	180mVpp	+10%, -15%	199x98x42mm	5902216703230	
000007	85-264VAC	12VDC	25A	300W	150mVpp	+10%, -15%	215x115x50mm	5902216716513	
4533	85-264VAC	12VDC	33A	400W	150mVpp	+10%, -15%	215x115x50mm	5902216721227	
003581	85-264VAC	12VDC	40A	500W	150mVpp	+10%, -15%	240x125x65mm	5902216721210	
421	85-264VAC	24VDC	8,5A	200W	100mVpp	+10%, -15%	199x98x42mm	5902216724419	
004715	85-264VAC	24VDC	12,5A	300W	100mVpp	+10%, -15%	200x110x50mm	5902216724426	
258	85-264VAC	24VDC	16,5A	400W	100mVpp	+10%, -15%	260x102x65mm	5902216724433	
497	85-264VAC	24VDC	1,5A	35W	100mVpp	+10%, -15%	84x58x38mm	5902216789791	
498	85-264VAC	24VDC	2,2A	50W	100mVpp	+10%, -15%	111x78x36mm	5902216789807	
1014	85-264VAC	24VDC	2,5A	60W	100mVpp	+10%, -15%	159x97x38mm	5902216703476	
6290	85-264VAC	24VDC	3,2A	75W	100mVpp	+10%, -15%	159x97x38mm	5902216705067	
121	85-264VAC	24VDC	4,5A	100W	100mVpp	+10%, -15%	199x98x38mm	5902216703483	
012954	85-264VAC	24VDC	6,25A	150W	100mVpp	+10%, -15%	198x98x42 mm	5902216799271	
002049	85-264VAC	24VDC	8,33A	200W	100mVpp	+10%, -15%	198x110x50mm	5902216703490	
002553	85-264VAC	24VDC	16,5A	400W	100mVpp	+10%, -15%	215x115x50mm	5902216703384	
6559	85-264VAC	24VDC	20A	500W	100mVpp	+10%, -15%	238x124x65mm	5902216703391	
002693	85-264VAC	24VDC	25A	600W	100mVpp	+10%, -15%	238x124x65mm	5902216703407	

IP

20 IN



Materiał / Materiál / Material

PL: aluminium

CZ: hliník

SK: hliník

EN: aluminium

BroLux

Zasilacz CCTV Slim

ZASILACZE LED STAŁONAPIĘCIOWY

CZ: Napájecí zdroje s konstantním napětím/ SK: Napájacie zdroje s konštantným napätím/ EN: LED power supply constant voltage



INDEX	IN	OUT			L x W x H	
012965	90-264 V AC	12 V DC	8,33 A	100 W	222x53x21	5902216799233
012964	90-264 V AC	12 V DC	12,5 A	150 W	212x65x31	5902216799240

IP



67

IN&OUT



Materiał / Materiál / Materiál

PL: Tworzywo sztuczne

CZ: Plast

SK: Plast

EN: Plastic





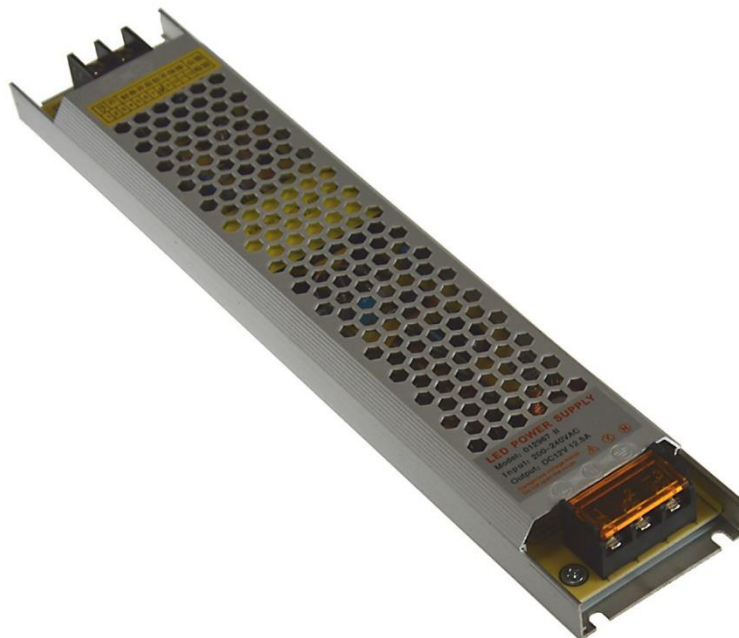

Brolux

Zasilacz Ultra Slim

ZASILACZE LED STAŁONAPIĘCIOWY

CZ: Napájecí zdroje s konstantním napětím/ SK: Napájacie zdroje s konštantným napätím/ EN: LED power supply constant voltage



INDEX	 IN	 OUT			 L x W x H	
012966	200-240 V AC	12 V DC	5 A	60 W		5902216799219
012967	200-240 V AC	12 V DC	12,5 A	150 W	269×53×21	5902216799226

IP



67

IN&OUT



Materiał / Materiál / Material

PL: Tworzywo sztuczne

CZ: Plast

SK: Plast

EN: Plastic







Brolux

Zasilacz Super Slim

ZASILACZE LED STAŁONAPIĘCIOWY

CZ: Napájecí zdroje s konstantním napětím/ SK: Napájacie zdroje s konštantným napätím/ EN: LED power supply constant voltage



INDEX	 IN	 OUT			 L x W x H	
012925	180-260V AC	12 V DC	1,5 A	18 W	172×18×18 mm	5902216799219
012926	180-260V AC	12 V DC	2 A	24 W	192×18×18 mm	5902216799158
012927	180-260V AC	12 V DC	3 A	36 W	282×18×18 mm	5902216799165
012928	180-260V AC	12 V DC	4 A	48 W	311×18×18 mm	5902216799172
012929	180-260V AC	12 V DC	5 A	60 W	311×18×18 mm	5902216799226

IP



20

IN



Materiał / Materiál / Material

PL: Tworzywo sztuczne

CZ: Plast

SK: Plast

EN: Plastic

Brolux

ZASILACZE DO PUSZKI



ZASILACZE LED STAŁONAPIECIOWE

CZ: Napájecí zdroje s konstantním napětím/ SK: Napájacie zdroje s konštantným napätím/ EN: LED power supply constant voltage



INDEX	IN	OUT				Ø x H	
006800	230VAC/50Hz	12VDC	0,83A	10W	-30°C ÷ +45°C	Ø 56x47x25mm	5902216722231
010852	230VAC/50Hz	12VDC	1,25A	15W	-30°C ÷ +45°C	Ø 56x47x25mm	5902216722248
007072	230VAC/50Hz	12VDC	1,67A	20W	-30°C ÷ +45°C	Ø 56x47x25mm	5902216722255

IP



67

IN&OUT



Materiał / Materiál / Material

PL: aluminium

CZ: hliník

SK: hliník

EN: aluminum

Br^olux

DESKTOP 12V/24V



ZASILACZE LED STAŁONAPIECIOWE

CZ: Napájecí zdroje s konstantním napětím/ SK: Napájacie zdroje s konštantným napätím/ EN: LED power supply constant voltage



INDEX	IN	OUT					
005330	100-240VAC	12VDC	1,0A	12W	120mVpp	±5%	5902216703049
005353	100-240VAC	12VDC	2,0A	24W	120mVpp	±5%	5902216747159
005165	100-240VAC	12VDC	3,0A	36W	120mVpp	±5%	5902216710900
001140	100-240VAC	12VDC	3,5A	42W	120mVpp	±5%	5902216789814
005331	100-240VAC	12VDC	4,0A	48W	120mVpp	±5%	5902216703056
005702	100-240VAC	12VDC	5,0A	60W	120mVpp	±5%	5902216721197
005382	100-240VAC	12VDC	6,0A	72W	120mVpp	±5%	5902216703063
010001	100-240VAC	12VDC	8,0A	96W	150mVpp	±5%	5902216703070
010000	100-240VAC	12VDC	10,0A	120W	180mVpp	±5%	5902216715530
5565	100-240VAC	24VDC	2,0A	48W	240mVpp	±5%	5902216710894

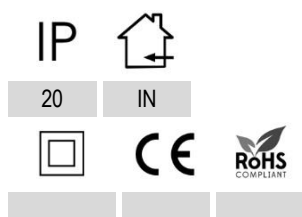

Materiał / Materiál / Material

PL: Tworzywo sztuczne

CZ: Plast

SK: Plast

EN: Plastic

Brolux

WTYCZKOWE 5V/9V/18V



ZASILACZE LED STAŁONAPIECIOWE

CZ: Napájecí zdroje s konstantním napětím/ SK: Napájacie zdroje s konštantným napätím/ EN: LED power supply constant voltage



INDEX	IN	OUT				+/-	
010004	100-240VAC	5V	1A	5W	1,5m	±5%	5902216703087
005731	100-240VAC	5V	2A	10W	1,5m	±5%	5902216703094
005729	100-240VAC	5V	3A	15W	1,5m	±5%	5902216703100
004119	100-240VAC	9V	2A	18W	1,5m	±5%	5902216703117
004044	100-240VAC	15V	1,5A	22,5W	1,5 m	±5%	5902216703148
004046	100-240VAC	18V	1A	18 W	1,5m	±5%	5902216725096
007548	100-240VAC	18V	1,5A	27W	1,5m	±5%	5902216703155

IP

20

IN



Materiał / Materiál / Material

PL: Tworzywo sztuczne

CZ: Plast

SK: Plast

EN: Plastic

Brolux

WTYCZKOWE 12V/24V



ZASILACZE LED STAŁONAPIECIOWE

CZ: Napájecí zdroje s konstantním napětím/ SK: Napájacie zdroje s konštantným napätím/ EN: LED power supply constant voltage



A



B



	INDEX	IN	OUT					
B	010002	100-240VAC	12VDC	0,5A	6W	100mVpp	±5%	5902216710917
B	004117	100-240VAC	12VDC	1,0A	12W	120mVpp	±5%	5902216703124
A	005333	100-240VAC	12VDC	1,0A	12W	120mVpp	±5%	5902216715554
B	005351	100-240VAC	12VDC	1,5A	18W	120mVpp	±5%	5902216715554
B	005352	100-240VAC	12VDC	2,0A	24W	120mVpp	±5%	5902216703131
B	008890	100-240VAC	12VDC	3,0A	36W	120mVpp	±5%	5902216789821
B	004045	100-240VAC	24VDC	1,0A	24W	240mVpp	±5%	5902216703162
B	004043	100-240VAC	24VDC	1,5A	36W	240mVpp	±5%	5902216710924

IP

20

IN



Materiał / Material / Material

PL: Tworzywo sztuczne

CZ: Plast

SK: Plast

EN: Plastic







Brolux







WTYCZKOWE 12V z wyłącznikiem

ZASILACZE LED STAŁONAPIĘCIOWE

CZ: Napájecí zdroje s konstantním napětím/ SK: Napájacie zdroje s konštantným napätím/ EN: LED power supply constant voltage



INDEX	 IN	 OUT				 L x W x H	
012962	100-240 V AC	12 V DC	2 A	150 W		73x63x43	5902216799196

 **IP**
 **IN**
 **20**
 **IN**



Materiał / Material / Material

PL: Tworzywo sztuczne

CZ: Plast

SK: Plast

EN: Plastic



ZASILACZE LED STAŁOPRĄDOWE

CZ: Napájecí zdroje s konstantním proudem/ SK: Napájacie zdroje s konštantným prúdom/ EN: LED power supply constant current



A



B



C



INDEX



L x W x H



0 423406 786012

	INDEX	IN	OUT	Current	Power	Size (L x W x H)	Barcode
A	009884	230VAC	3-8V	700 mA	6W	42×40×21mm	5902216711396
B	009889	230VAC	30-48V	330 mA	15W	152×60×23mm	5902216748675
B	009892	230VAC	36-68V	350 mA	24W	152×60×23mm	5902216746695
B	009894	230VAC	15-24V	700 mA	15W	152×60×23mm	5902216748699
B	009896	230VAC	22-32V	700 mA	20W	152×60×23mm	5902216748705
B	009897	230VAC	36-62V	700 mA	42W	152×60×23mm	5902216748712
C	012211	200-240 VAC	28-42 V	950 mA	40W	130×45×30 mm	5902216792302
C	012212	200-240 VAC	27-42 V	1,1 A	44W	130×45×30 mm	5902216792319

IP



20

IN



CE



Materiał / Materiál / Materiál

PL: Tworzywo sztuczne

CZ: Plast

SK: Plast

EN: Plastic

ZASILACZE LED STAŁOPRĄDOWE

CZ: Napájecí zdroje s konstantním proudem/ SK: Napájacie zdroje s konštantným prúdom/ EN: LED power supply constant current



A



B



INDEX



L x W x H



0 423406 786012

	INDEX	IN	OUT	Current	Power	Dimensions	Barcode
A	012148	230VAC	28-48 V DC	115mA	12 W	70×24 mm	5902216792876
A	012147	230VAC	24-48 V DC	450mA	18 W	70×25 mm	5902216792890
A	012149	230VAC	24-48 V DC	600mA	24 W	74×26 mm	5902216792913
A	012150	230VAC	24-48 V DC	820mA	36 W	74×26 mm	5902216792937
B	012151	230VAC	24-48 V DC	300mA	12 W	79×29×39 mm	5902216792883
B	012152	230VAC	24-48 V DC	450mA	18 W	80×23×39 mm	5902216792906
B	012153	230VAC	24-42 V DC	600mA	24 W	105×25x38 mm	5902216792920

IP

20

IN



Materiał / Materiál / Material

PL: Tworzywo sztuczne

CZ: Plast

SK: Plast

EN: Plastic

METALOWE



ZASILACZE LED STAŁOPRĄDOWE

CZ: Napájecí zdroje s konstantním proudem/ SK: Napájacie zdroje s konštantným prúdom/ EN: LED power supply constant current



INDEX	IN	OUT			IP	L x W x H	
010668	230VAC	5-32V	350mA	12W	IP67	160x30x20mm	5902216748781
010670	230VAC	5-45V	700mA	30W	IP67	200x30x20mm	5902216748651

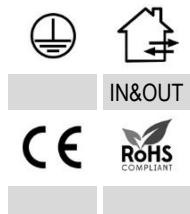

Materiał / Materiál / Material

PL: aluminium

CZ: hliník

SK: hliník

EN: aluminum



ZASILACZE LED STAŁOPRĄDOWE

CZ: Napájecí zdroje s konstantním proudem/ SK: Napájacie zdroje s konštantným prúdom/ EN: LED power supply constant current



INDEX	IN	OUT					L x W x H	
580	230VAC	12-24V	280mA	4-7W	80mVpp	+10%, -15%	42×40×21mm	5902216700161
527	230VAC	24-44V	280mA	9-12W	80mVpp	+10%, -15%	42×40×21mm	5902216700178
528	230VAC	36-60V	280mA	15-18W	80mVpp	+10%, -15%	42×40×21mm	5902216700185
540	230VAC	72-84V	280mA	18-24W	80mVpp	+10%, -15%	42×40×21mm	5902216700192

IP

20

IN



Materiał / Materiál / Material

PL: Tworzywo sztuczne

CZ: Plast

SK: Plast

EN: Plastic

ZASILACZE LED STAŁOPRĄDOWE

CZ: Napájecí zdroje s konstantním proudem/ SK: Napájacie zdroje s konštantným prúdom/ EN: LED power supply constant current



INDEX	IN	OUT				L x W x H	
5877	230VAC	25-40V	290mA	9-12W	0°C ÷ +45°	111x42x27.8mm	5902216717107
7084	230VAC	45-65V	290mA	15-18W	0°C ÷ +45°	132x45x24mm	5902216717114
7143	230VAC	70-90V	290mA	18-24W	0°C ÷ +45°	132x45x24mm	5902216717121

IP



20

IN



Materiał / Materiał / Material

PL: Tworzywo sztuczne

CZ: Plast

SK: Plast

EN: Plastic

ZASILACZE LED STAŁOPRĄDOWE

CZ: Napájecí zdroje s konstantním proudem/ SK: Napájacie zdroje s konštantným prúdom/ EN: LED power supply constant current



A



B

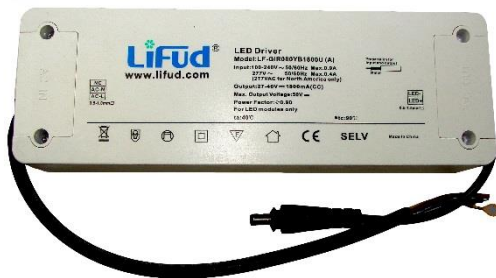

C



D



INDEX



IN



OUT



L x W x H



9 723459 788012

	INDEX	IN	OUT	W	Temp	Dimensions	Barcode	
A	001937	230VAC	27-42V	950mA	40W	0°C ÷ +45°	145x43x30mm	5902216709669
B	000008	230VAC	27-42V	1200mA	50W	0°C ÷ +45°	150x50x30mm	5902216709652
C	000146	230VAC	30-36V	1800mA	60W	0°C ÷ +45°	190x62x30mm	5902216709645
D	002706	230VAC	27-40V	1800mA	80W	0°C ÷ +45°	190x62x30mm	5902216709638

IP



20

IN



CE



RoHS COMPLIANT

Materiał / Materiál / Materiál

PL: Tworzywo sztuczne

CZ: Plast

SK: Plast

EN: Plastic

AKTYWNY PF



ZASILACZE LED STAŁOPRĄDOWE

CZ: Napájecí zdroje s konstantním proudem/ SK: Napájacie zdroje s konštantným prúdom/ EN: LED power supply constant current



INDEX	IN	OUT				L x W x H	
012116	230VAC	28-42V	950mA	40W	0°C ÷ +45°	130x45x30 mm	5902216791480
012390	230VAC	30-40V	1,2A	48W	0°C ÷ +45°	155x50x35 mm	5902216794849

IP



20

IN



Materiał / Materiál / Material

PL: Tworzywo sztuczne

CZ: Plast

SK: Plast

EN: Plastic

BroLux

www.bowi.com.pl

0-10V



ZASILACZE ŚCIEMNIALNE

CZ: stmívatelné napájecí zdroje / SK: stmievateľné napájacie zdroje / EN: LED power supply dimmable



INDEX	IN	OUT				L x W x H	
007969	230VAC	30-36V	1800mA	60W	0°C ÷ +45°	190x62x30mm	5902216709614

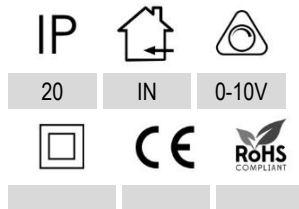

Materiał / Materiál / Material
PL: Tworzywo sztuczne
CZ: Plast
SK: Plast
EN: Plastic



DALI



ZASILACZE ŚCIEMNIALNE

CZ: stmívatelné napájecí zdroje / SK: stmievateľné napájacie zdroje / EN: LED power supply dimmable

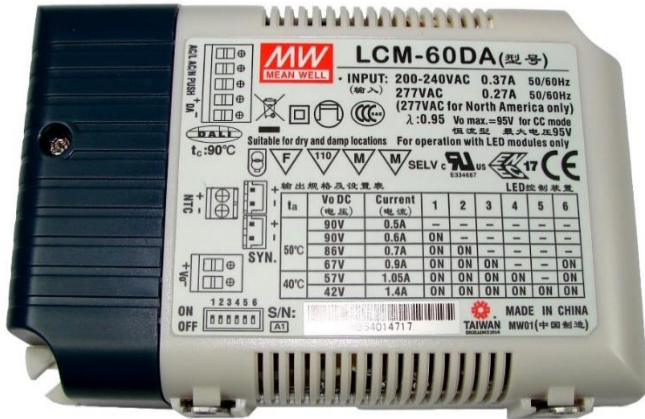

A

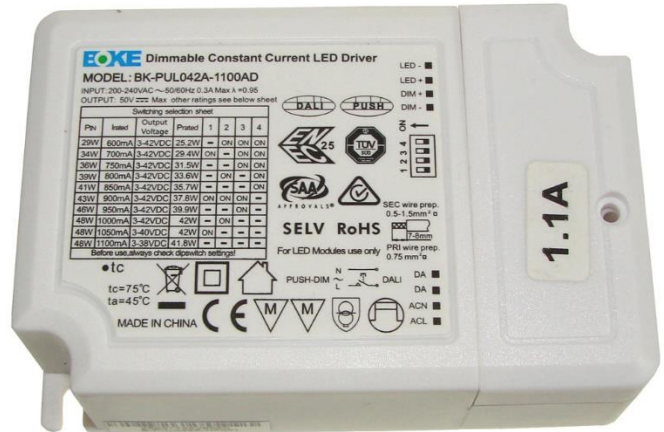

B



	INDEX	IN	OUT	AC	Power	Temp	Dimensions (L x W x H)	Barcode
A	003748	230VAC	9-42V	1400mA	60W	0°C ÷ +45°	123x80x25mm	5902216709676
B	012189	200-240VAC	3-42V	1100mA	42 W	0°C ÷ +45°	104x69x30mm	5902216793651

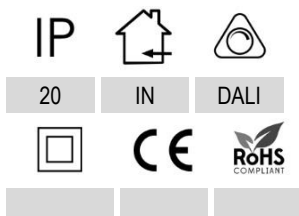

Materiał / Materiál / Material
 PL: Tworzywo sztuczne
 CZ: Plast
 SK: Plast
 EN: Plastic



Zasilacz CCTV Slim



ZASILACZE STAŁOPRĄDOWE

CZ: Napájecí zdroje s konstantním proudem/ SK: Napájacie zdroje s konštantným prúdom/ EN: LED power supply constant current



INDEX	IN	OUT				L x W x H	
012918	230 V AC	12 V DC	5 A	60 W	0°C ÷ +45°	161×40×32	5902216799288
012919	230 V AC	12 V DC	8,33 A	100 W	0°C ÷ +45°	189×46×37	5902216799295
012920	230 V AC	12 V DC	10 A	120 W	0°C ÷ +45°	187×41×35	5902216799301
012921	230 V AC	12 V DC	12,5 A	150 W	0°C ÷ +45°	200×57×39	5902216799318
012922	230 V AC	12 V DC	16,66 A	200 W	0°C ÷ +45°	223×68×40	5902216799318
012957	230 V AC	24 V DC	6,25 A	150 W	0°C ÷ +45°	199×58×40	5902216799332

IP



20

IN



Materiał / Materiál / Material

PL: Tworzywo sztuczne

CZ: Plast

SK: Plast

EN: Plastic

Brolux

WTYK DC 2,1/5,5



TRANSFORMATORY ZASILANIA

CZ: výkonové transformátory/ SK: výkonové transformátory/ EN: power connectors



A



B



C

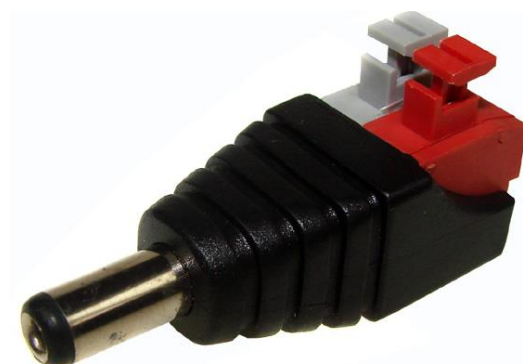

D



INDEX



Measure unit



	INDEX		Measure unit	
A	005410	wtyk DC 2,1/5,5 I	SZT	5902216720800
B	6188	wtyk DC 2,1/5,5 II	SZT	5902216703612
C	2023	wtyk DC 2,1/5,5 II	OP/20	5902216786479
D	011684	wtyk DC 2,1/5,5 terminal	SZT	5902216757813



BroLux

GNIAZDO DC 2,1/5,5

TRANSFORMATORY ZASILANIA

CZ: výkonové transformátory/ SK: výkonové transformátory/ EN: power connectors



A



B

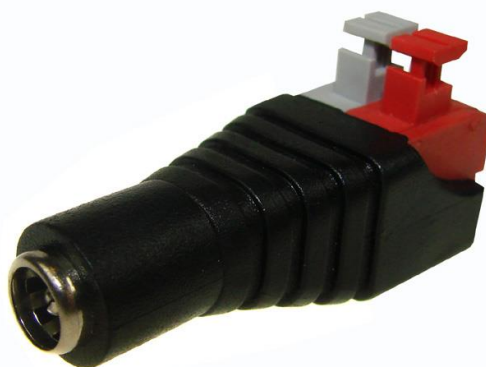

C



INDEX



Measure unit



	INDEX		Measure unit	
A	6194	gniazdo DC 2,1/5,5 I	SZT	5902216716537
B	2082(1)	gniazdo DC 2,1/5,5 II	OP/20	5902216786486
B	2000	gniazdo DC 2,1/5,5 II	SZT	5902216703605
D	011685	gniazdo DC 2,1/5,5 termial	SZT	5902216757820



GNIAZDA DC



GNIAZDA DC

CZ: DC zásuvky / SK: DC zásuvky/ EN: female DC



INDEX



Measure unit



B	009814	Gniazdo DC 2,1/5,5	30cm	Biały biła bielá white	szt.	5902216703636
A	011720	Gniazdo DC 2,1/5,5	30cm	Czarny Černá Čierná Black	OP/100	5902216786660
A	011723	Gniazdo DC 2,1/5,5	45cm		OP/100	5902216786714
A	011721	Gniazdo DC 2,5/5,5	45cm		OP/100	5902216786677
A	003816	Gniazdo DC 2,5/5,5	100cm		szt.	5902216725188
A	011722	Gniazdo DC 2,1/5,5	100cm		OP/50	5902216786707
C	1102	Gniazdo DC podwójne 2,1/5,5	-		szt.	5902216786318



Brolux

WTYKI DC



WTYKI DC

CZ: DC zástrčky / SK: DC konektory / EN: male DC



INDEX



Measure unit



A	011758	Wtyk DC 2,1/5,5	10cm	Czarny Černá Čierná Black	OP/100	5902216786929
A	011757	Wtyk DC 2,1/5,5	30cm		OP/100	5902216786912
B	011759	Wtyk DC 2,1/5,5	30cm	Biały біла bielá white	OP/100	5902216786936
A	011760	Wtyk DC 2,1/5,5	45cm	Czarny Černá Čierná Black	OP/100	5902216786943
A	002071	Wtyk DC 2,5/5,5	45cm		szt.	5902216715943
C	005698	Wtyk DC 2,1/5,5 podwójny	-		szt.	5902216723481



Brolux

KABLE I ROZGAŁĘŹNIKI DC



KABLE I ROZGAŁĘŹNIKI DC

CZ: DC kabely / SK: DC káble / EN: DC cables



INDEX



Measure unit



A	004457	Kabel wtyk DC 2,1/5,5-wt.DC 2,1/5,5	0,4m	szt.	5902216723436
B	011756	Kabel wtyk DC 2,1/5,5-gniazdo DC 2,1/5,5	1,5m	OP/20	5902216786905
B	005011	Kabel wtyk DC 2,1/5,5-gniazdo DC 2,1/5,5	3m	szt.	5902216702462
B	005142	Kabel wtyk DC 2,5/5,5-gniazdo DC 2,5/5,5	2m	szt.	5902216715936
C	5596	Rozgałęźnik zasilania DC 1gn./2wt. 2,1/5,5	25cm	szt.	5902216723467
C	005695	Rozgałęźnik zasilania DC 1gn./2wt. 2,1/5,5	50cm	szt.	5902216715950
C	007040	Rozgałęźnik zasilania DC 1gn./2wt. 2,5/5,5	25cm	szt.	5902216786349
C	007041	Rozgałęźnik zasilania DC 1gn./2wt. 2,5/5,5	50cm	szt.	5902216728820
D	6461	Rozgałęźnik zasilania DC 1gn./4wt. 2,1/5,5	25cm	szt.	5902216702790
D	005411	Rozgałęźnik zasilania DC 1gn./4wt. 2,1/5,5	40cm	szt.	5902216720817
D	2001	Rozgałęźnik zasilania DC 1gn./4wt. 2,1/5,5	1,5m	szt.	5902216744554
E	002161	Rozgałęźnik zasilania DC 1gn./8wt. 2,1/5,5	25cm	szt.	5902216730168
E	010212	Rozgałęźnik zasilania DC 1gn./8wt. 2,1/5,5	40cm	szt.	5902216723610
E	007039	Rozgałęźnik zasilania DC 1gn./8wt. 2,5/5,5	25cm	szt.	5902216728813



Brolux

PHU BOWI

Professional importer

PHU BOWI
ul. Magazynowa 7
80-180 Gdańsk-Kowale
NIP 5891414986

tel. +48 58 554 83 17
fax. +48 58 554 85 11
biuro@bowi.com.pl
www.bowi.com.pl



Katalog produktów 2018-2019

Katalog výrobků 2018-2019 \ Katalog výrobkov 2018-2019 \ Products catalogue 2018-2019